

The HMX4 series of Gefran are pressure transmitters with HART communication protocol for using in high temperature environment with explosive atmosphere presence. The main characteristic of this series is the capability to read temperature of the media up to 400°C. The constructive principle is based on the hydraulic transmission of the pressure. The fluid-filled system assures the temperature stability. The physical measure is transformed in a electrical measure by means of thick film strain-gauge technology. The **SIL2** and **PL d** approvals make the product suitable for use in the **Functional Safety** applications, particularly in the process plants for the production of polymers, where it is an essential requirement.

MAIN FEATURES

- Pressure ranges from: 0-17 to 0-2000 bar/0-250 to 0-30000 psi
- Thick film extensimetric measurement principle
- Accuracy: $\pm 0.25\% \text{ FS (H)}$; $\pm 0.5\% \text{ FS (M)}$
- SIL2 and PL d approvals for Functional Safety
- ATEX certification for potentially explosive atmospheres
- Flanged version (see drawing for details)
- Protection level: IP66 (6-pin connector)
- 1/2-20UNF, M18x1.5 standard threads; other types available on request
- Standard diaphragm is 15-5 PH stainless steel with GTP+ coating
- 17-7 PH corrugated stainless steel diaphragm with GTP+ coating for ranges below 100 bar-1500 psi
- Other diaphragm types available on request

MAIN INTRINSIC SAFETY CHARACTERISTICS

Transmitter designed and produced in compliance with Directive ATEX 2014/34/EU and according to European standards.
Protection mode: group II, category 1G, 1D
GAS protection mode: Ex ia IIC T6, T5, T4 Ga (Ambient Temp.: -20°C...+60°C / +75°C / +85°C)
DUST protection mode: Ex ia IIIC T85°C, T100°C, T135°C Da IP65 (Ambient Temp.: -20°C...+60°C / +75°C / +85°C)

Maximum voltage	30 V
Maximum current	100 mA
Maximum power	0,75 W
Maximum inductance (*)	17 μ H
Maximum capacity (*)	10 nF
(*) includes inductance levels and capacity of a cable: (typical L 1microH/m and typical C 100pF/m) with maximum length 15m.	

The Melt pressure transmitters must be connected to other equipment (galvanic isolation barriers) with individual ATEX certification such as [Ex ia Ga] IIC.
EC-Type Examination Certificate number: **DNV 13 ATEX 3894**

TECHNICAL SPECIFICATIONS

Accuracy (1)	H $\pm 0.25\% \text{ FS (100...2000 bar)}$ M $\pm 0.5\% \text{ FS (17...2000 bar)}$
Resolution	16 bit
Measurement range	0..17 to 0..2000bar 0..250 to 0..30000psi
Rangeability	3:1
Maximum overpressure (without degrading performances)	2 x FS 1.5 x FS above 1000bar/15000psi
Measurement principle	Extensimetric thick film
Power supply	13...30Vdc
Maximum current absorption	23mA
Output signal Full Scale (FS)	20mA
Zero balance (tolerance $\pm 0.25\% \text{ FS}$)	4mA
Calibration signal	80% FS
Power supply polarity reverse protection	YES
Compensated temperature range housing	0...+85°C
Operating temperature range housing	-30...+85°C
Storage temperature range housing	-40...+125°C
Thermal drift in compensated range: Zero / Calibration / Sensibility	<math>< 0.02\% \text{ FS}/^\circ\text{C}</math>
Diaphragm maximum temperature	400°C / 750°F
Zero drift due to change in process temperature (zero)	<math>< 0.02 \text{ bar}/^\circ\text{C}</math>
Standard material in contact with process medium	Diaphragm: • 15-5 PH with GTP+ coating • 17-7 PH corrugated diaphragm with GTP+ coating for ranges <math>< 100 \text{ bar (1500psi)}</math> Stem: • 17-4 PH
Protection degree (with 6-pole female connector CON300)	IP66
SIL2 certification	IEC/EN 62061 / IEC 61508
PL d certification	EN ISO 13849
FS = Full scale output (1) BFSL method (Best Fit Straight Line): includes combined effects of Non-Linearity, Hysteresis and Repeatability (according to IEC 62828-2)	

MECHANICAL DIMENSIONS

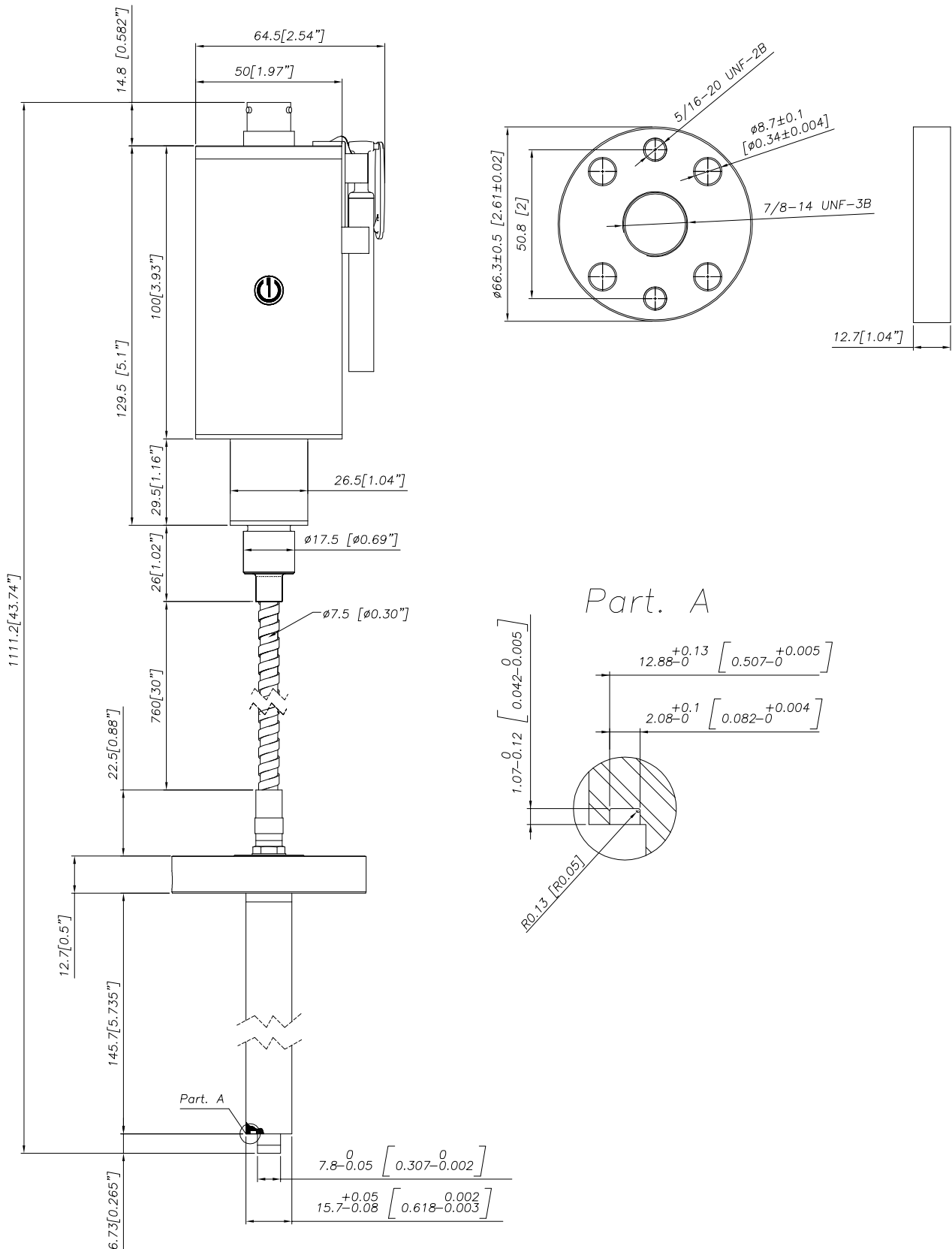

NOTE: dimensions refer to rigid stem length option "4" (153 mm-6")

SELF DIAGNOSTICS (ONLY FOR SIL2 / PL d VERSIONS)

Below the conditions detected by the sensor self-diagnostics:

- Cut cable / device non connected / broken power supply, output $\leq 3.6\text{mA}$
- Pin detachment output $\leq 3.6\text{mA}$
- Broken primary element $\geq 21\text{mA}$
- Pressure above 200% of the span, output $\geq 21\text{mA}$
- Voltage monitor in case of overvoltage/undervoltage/voltage variation in the electronics, output $\leq 3.6\text{mA}$ (*)
- Program sequence error, output $\leq 3.6\text{mA}$ (*)
- Overtemperature on the electronics, output $\leq 3.6\text{mA}$ (*)
- Error on the primary element output or on the first amplification stage, output $\geq 21\text{mA}$

(*) In such conditions the Alarm Type can be programmed via HART at $\geq 21\text{mA}$.

NAMUR COMPLIANCE (ONLY FOR SIL2 / PL d VERSIONS)

The sensors are tested according to Namur NE21 recommendations. The same compatibility is valid for the NE43 Namur recommendation with the following sensor behaviour in case of breakdown:

- Cut cable: breakdown information as the signal is $\leq 3.6\text{mA}$
- Device not connected: breakdown information as the signal is $\leq 3.6\text{mA}$
- Broken power-supply: breakdown information as the signal is $\leq 3.6\text{mA}$
- or in case of performance problems:
- Broken primary element $\geq 21\text{mA}$
- Pressure above 200% of the span, output $\geq 21\text{mA}$
- Others $\leq 3.6\text{mA}$ (*)

(*) In such a condition the Alarm Type can be programmed via HART at $\geq 21\text{mA}$.

Note: in all the remaining situations, the output signal is always included between 3.8 and 20.5mA.



Recommendation: the error level set by the customer (e.g. maximum pressure value) has to be inside the nominal range.

LOAD DIAGRAM

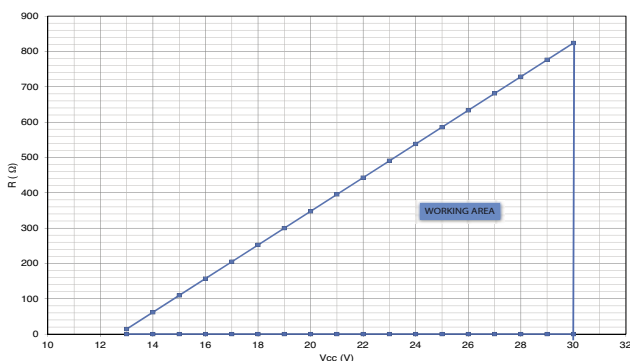

The diagram shows the optimum ratio between load and power supply for transmitters with 4...20mA output. For correct function, use a combination of load resistance and voltage that falls within the two lines in the graph above.

AUTOZERO FUNCTION

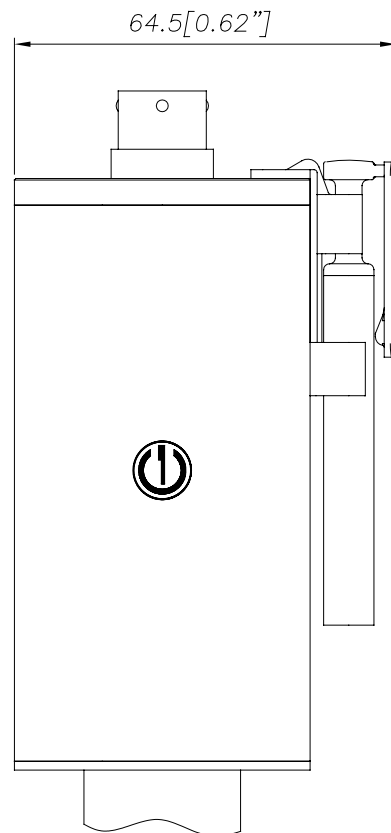

The Autozero function is activated through a magnetic contact (external magnet supplied with the sensor). The Autozero function can be activated through HART command as well. See the manual for a complete Autozero function explanation.

ELECTRICAL CONNECTIONS

CURRENT OUTPUT

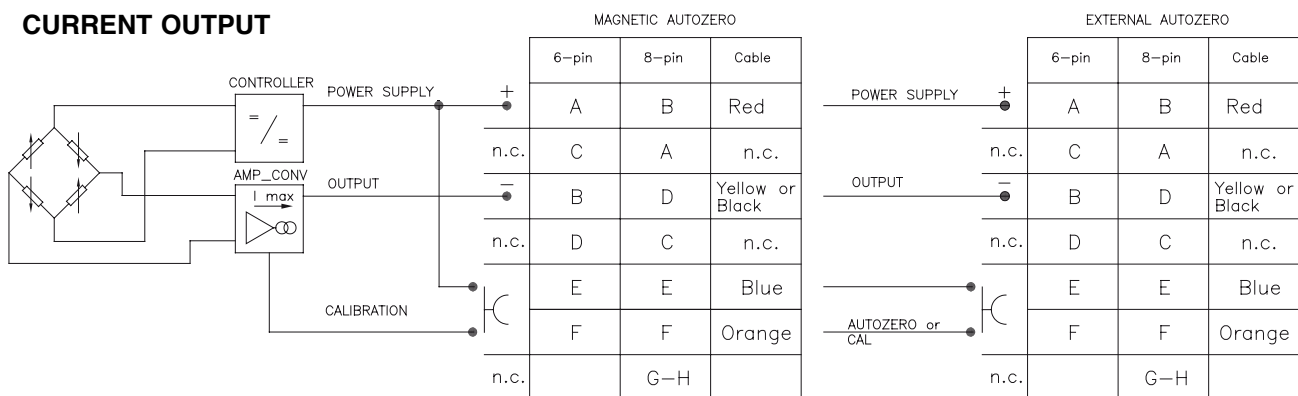

The cable shield is tied to both sides, i.e. to the sensor connector and to the controller

6 pin Connector
VPT07RA10-6PT2
(PT02A-10-6P)

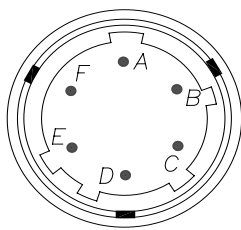

8 pin Connector
(PC02E-12-8P) Bendix

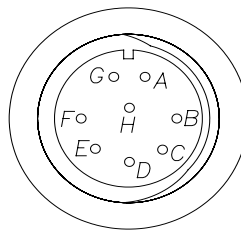

Cable outlet (1/2 14-NPT)
Current output
L = 1 m

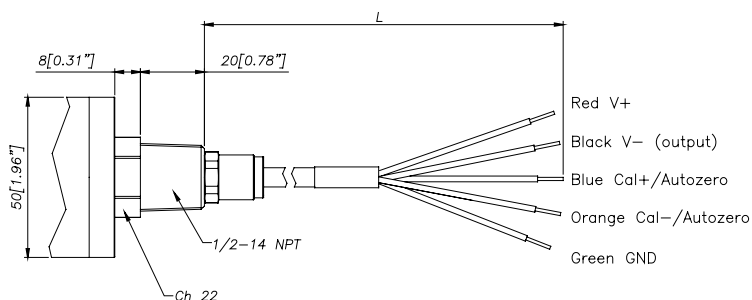

ACCESSORIES

Connectors

6-pin female connector (IP66 protection degree)

8-pin female connector

Accessories

Mounting bracket

Copper washer silver plated

Fixing pen clip

Autozero pen

Extension cables

6-pin connector with 3mt Atex cable

6-pin connector with 4mt Atex cable

6-pin connector with 5mt Atex cable

6-pin connector with 10mt Atex cable

CON300

CON307

SF18

RON007

PKIT1032

PKIT378

PCAV221

PCAV104

PCAV105

PCAV106

Cable color code	
Conn.	Wire
A-2	Red
B-4	Black
C-1	White
D-6	Green
E-7	Blue
F-3	Orange
5	Grey
8	Pink

ORDER CODE

HM - - - - - 0000 X 000 X 0

000= Special executions

OUTPUT SIGNAL	
4...20mA	X

VERSION	
Flange mounting	4

CONNECTOR	
6 pin	6
8 pin	8
NPT Cable	N

ACCURACY CLASS	
0.25% FS (ranges \geq 100 bar/1500 psi)	H
0.5% FS	M

MEASUREMENT RANGE			
bar		psi	
17	B17U	250	P25D
35	B35U	500	P05C
50	B05D	750	P75D
70	B07D	1000	P01M
100	B01C	1500	P15C
200	B02C	3000	P03M
350	B35D	5000	P05M
500	B05C	7500	P75C
700	B07C	10000	P10M
1000	B01M	15000	P15M
1400	B14C	20000	P20M
2000	B02M	30000	P30M

FLANGE MOUNTING	
Standard	
\varnothing 66.3mm (2.61")	6

4	T4 Ex ia IIC T4 Ga (Tambient: -20°C...+85°C)/Ex ia IIIC T135°C Da IP65
5	T5 Ex ia IIC T5 Ga (Tambient: -20°C...+75°C)/Ex ia IIIC T100°C Da IP65
6	T6 Ex ia IIC T6 Ga (Tambient: -20°C...+60°C)/Ex ia IIIC T85°C Da IP65

E	External Autozero (*)
0	Magnetic Autozero

(*) as an alternative to the CAL function

P	Performance Level='d'
S	SIL2
0	Standard 4...20mA

FLEXIBLE ROD LENGTH (mm/inches)		
F	760mm	30"

RIGID ROD LENGTH (mm/inches)		
Standard		
4	153mm	6"
Available on request		
H	102mm	4"
M	229mm	9"
5	305mm	12"

Example

HMX4-N-M-B07C-6-4-F-S-0-4

Melt pressure transmitter, 4...20mA output with HART protocol, NPT cable, flange mounting, 700 bar pressure range, 0.5% accuracy, 153 mm (6") rigid rod, 760 mm (30") flexible rod, SIL2 approval, temperature class T4 (-20°C...+85°C).

Sensors are manufactured in compliance with:

- EMC compatibility directive: 2014/30/EU
- ATEX directive: 2014/34/EU
- MACHINERY directive: 2006/42/EC

Product designed and available in compliance with Directive 2011/65/EU (RoHS II) only for large-scale stationary installation or industrial tools, or for B-to-B laboratory equipments for R&D purposes.

Electrical installation requirements and conformity certificate are available on our web site: www.gefran.com

GEFRAN spa reserves the right to make any kind of design or functional modification at any moment without prior notice.



GEFRAN spa
 via Sebina, 74
 25050 PROVAGLIO D'ISEO (BS) - ITALIA
 tel. 0309888.1 - fax. 0309839063
 Internet: <http://www.gefran.com>