

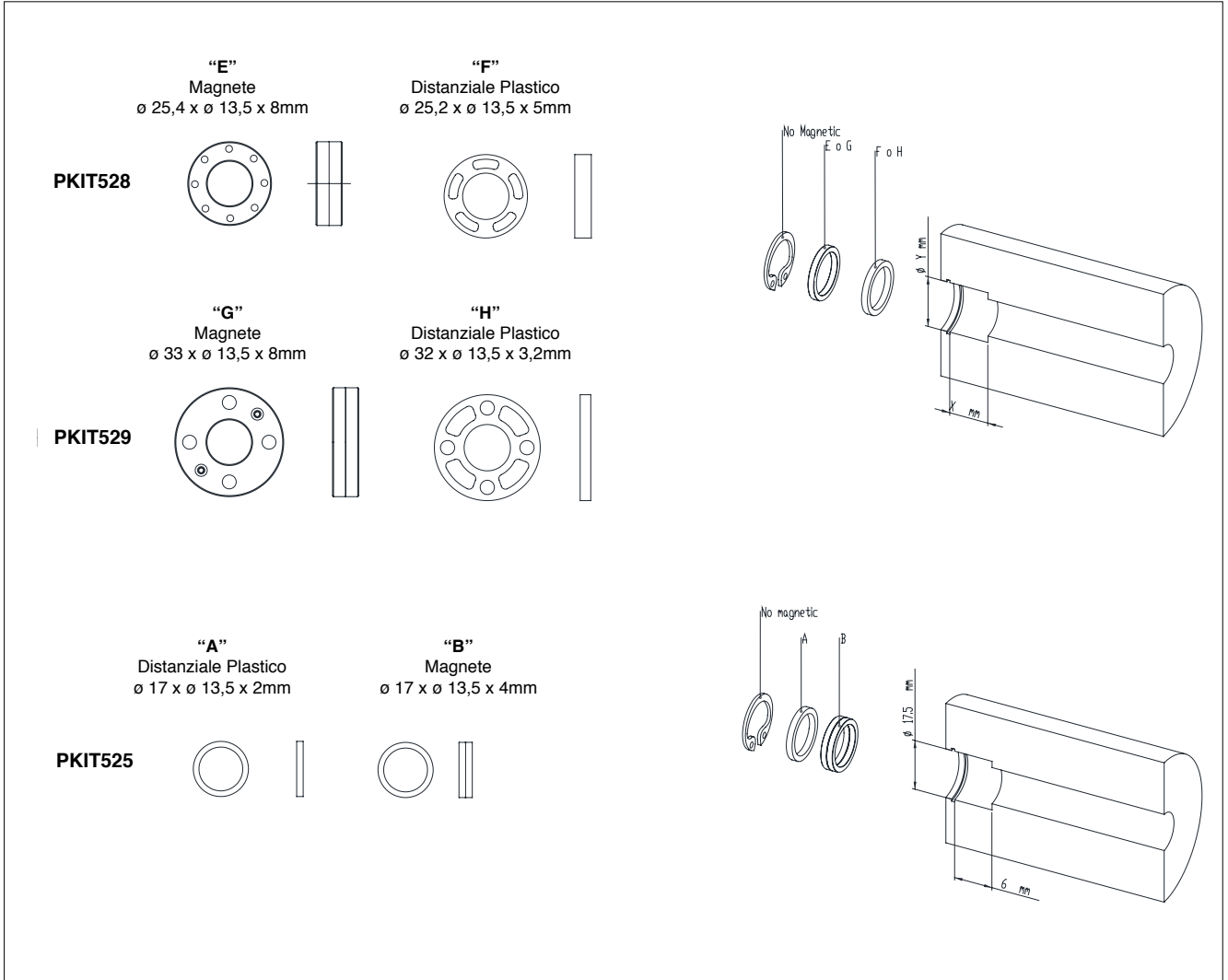

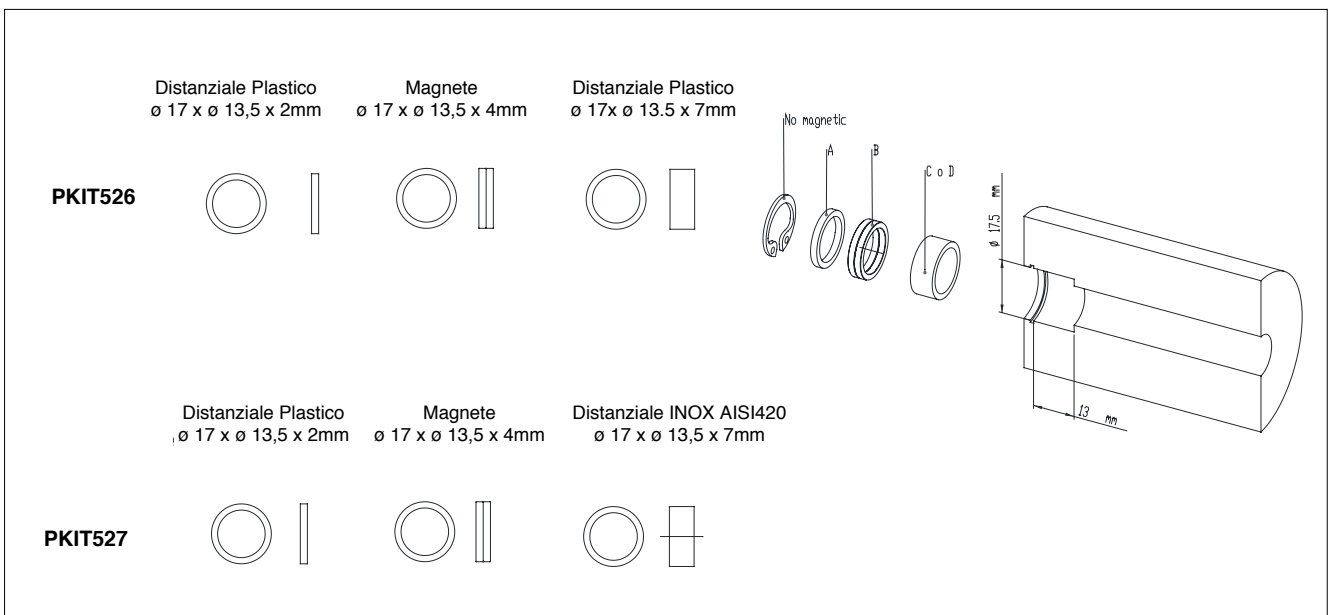









### KIT CURSORE (da ordinare separatamente)



### KIT CURSORE PER SEDE DA 13mm (da ordinare separatamente)



## KIT CURSORI (ordinare separatamente)

CODICE	Ø SEDE	PROFONDITA' SEDE	MATERIALE PISTONE	MAGNETE	DISTANZIALE PLASTICO	DISTANZIALE AMAGNETICO	DISTANZIALE MAGNETICO
PKIT528	Ø 25,4 mm	13 mm	magnetico/ amagnetico				
PKIT529	Ø 33 mm	13 mm	magnetico/ amagnetico				
PKIT525	Ø 17 mm	6 mm	magnetico/ amagnetico				
PKIT526	Ø 17 mm	13 mm	amagnetico				
PKIT527	Ø 17 mm	13 mm	magnetico				

## ACCESSORI

### PKIT 615

Estrattore accessorio per connettore intermedio

## CONNETTORI OPZIONALI

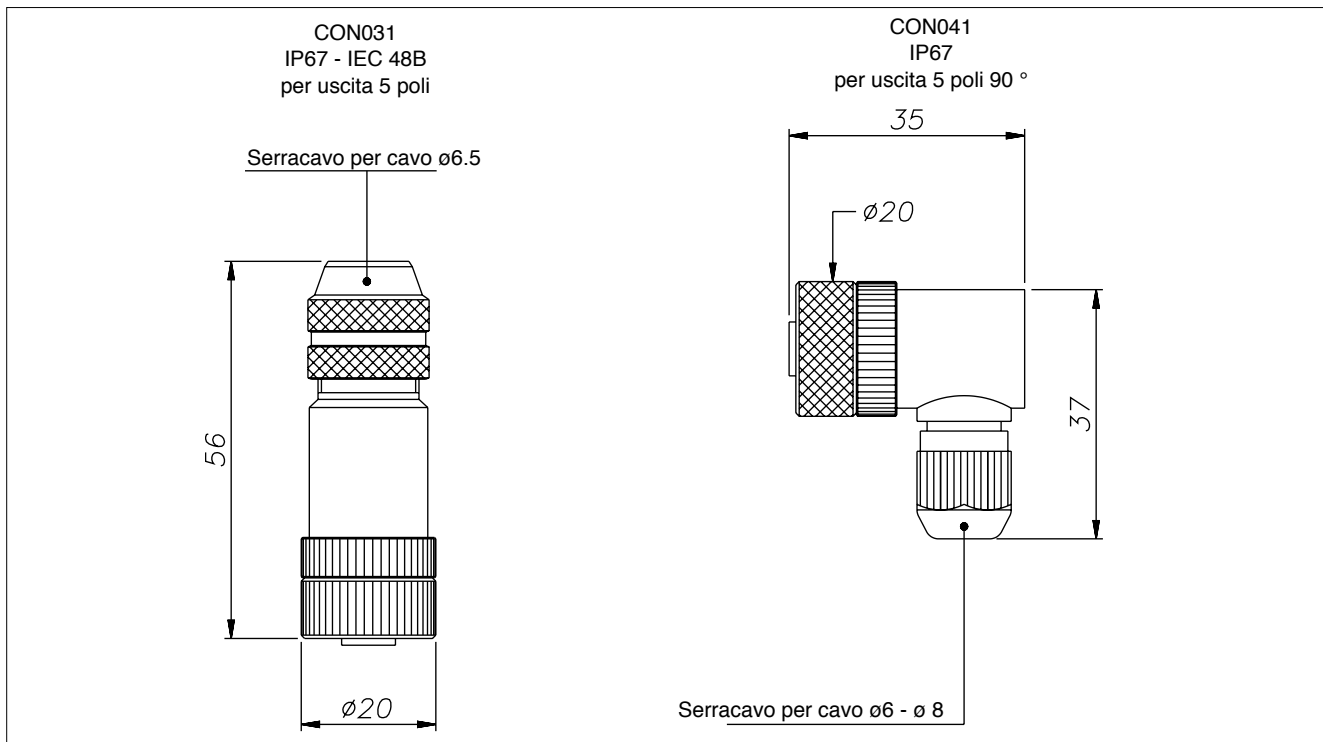

## CAVI OPZIONALI (ordinare separatamente)

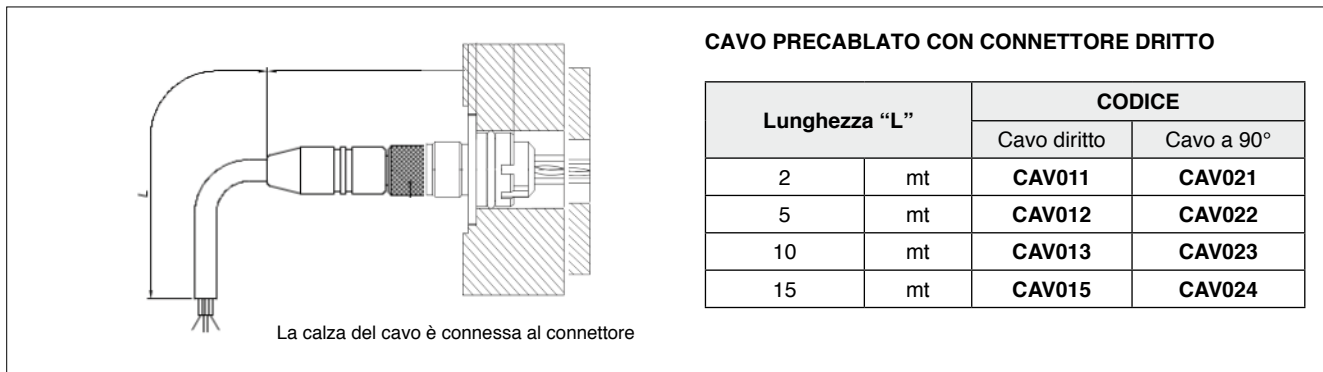

GEFRAN spa si riserva il diritto di apportare modifiche estetiche o funzionali in qualsiasi momento e senza preavviso alcuno

**GEFRAN spa**

via Sebina, 74 - 25050 PROVAGLIO D'ISEO (BS) - ITALIA

ph. 0309888.1 - fax. 0309839063

Internet: <http://www.gefran.com>

**GEFRAN**

DTS\_ACCESSORI-RK-5\_06-2014\_ITA