



**INSTALLATION AND
OPERATION MANUAL**

codice: 80416C- 01-2021 - ENG

INDEX

1 • INTRODUCTION.....2

2 • Main characteristics.....3

3 • Physical connection to lan network3

4 • Connecting host devices.....3

5 • Description of data exchanged by GFX4-ETH2.....5

6 • From DDF description file to data exchange5

7 • PROCESS DATA STRUCTURE (PDO)6

 7.1. Description of pdos in reception for GFX4 with 20 zone6

 7.2. Description of pdos in transmission for GFX4 with 20 zone.....9

8 • OBJECT DICTIONARY (SDO)13

 8.1. GFX4.....13

 8.2. GFX4-IR19

 8.3. Installation and configuration example with TwinCAT environment26

1 • INTRODUCTION

The GFX4/GFX4-IR/GFXTERMO4 ordered with the option “E2”, or equipped later with the option card GFX4-ETH2, support the EtherCAT Slave CoE (canopen over EtherCAT) protocol.
The communication logic scheme can be simplified as shown below:

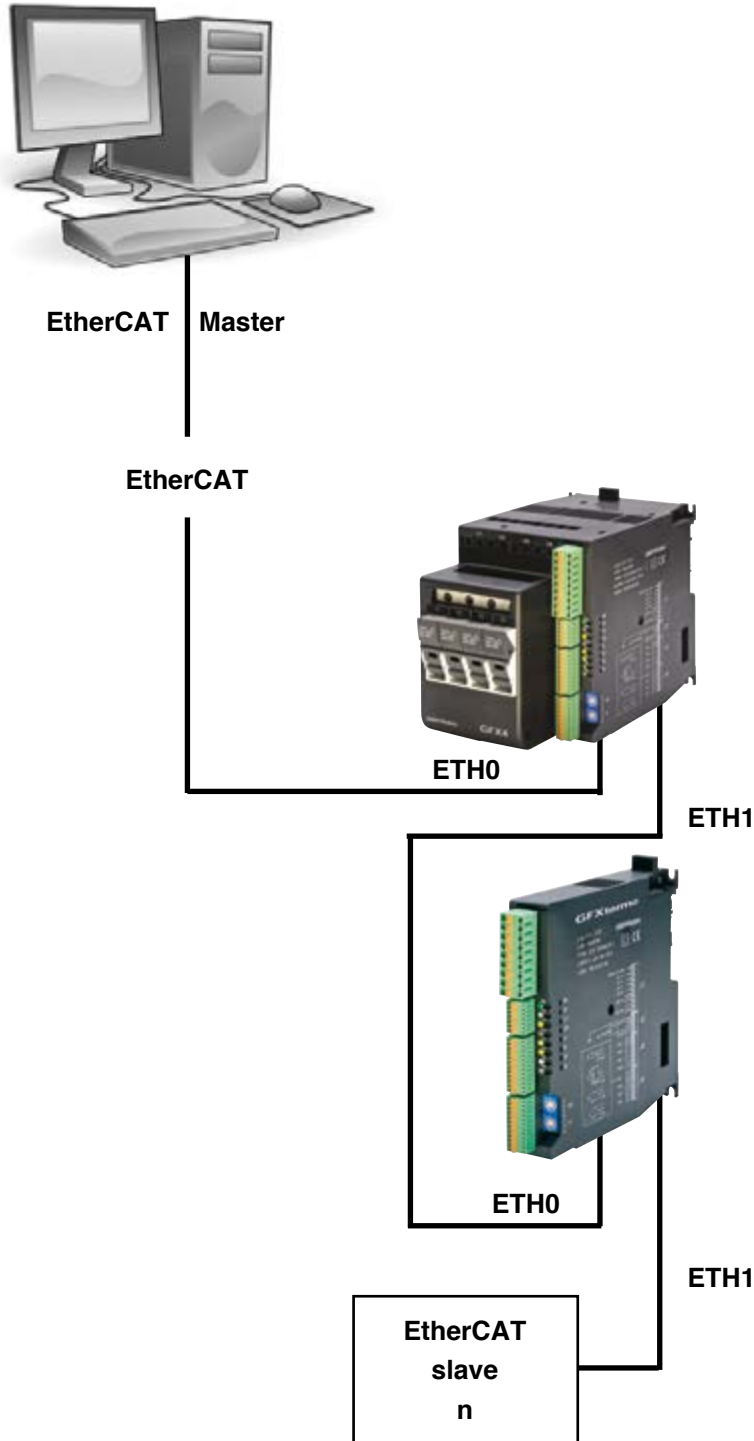

2 · MAIN CHARACTERISTICS

- Data transport layer Ethernet II , IEEE 802.3
- Two RJ45 connections: Eth 0 IN and Eth 1 Out
- Baud rate 100Mbit/s
- Supports Canopen over EtherCAT CoE
- Supports SDO Master- Slave communication
- Supports PDO communication
- Supports Object Dictionary via device description file (DDF)
- Complex slave device
- Ability to address via 3 rotaries

3 · PHYSICAL CONNECTION TO LAN NETWORK

The GFX4-ETH2 board has two RJ45 connections to connect to other slave devices or to a master.

Specifically:

- An Eth0 port for input connection
- An Eth1 port for output connections

In general, the following connection methods are possible:

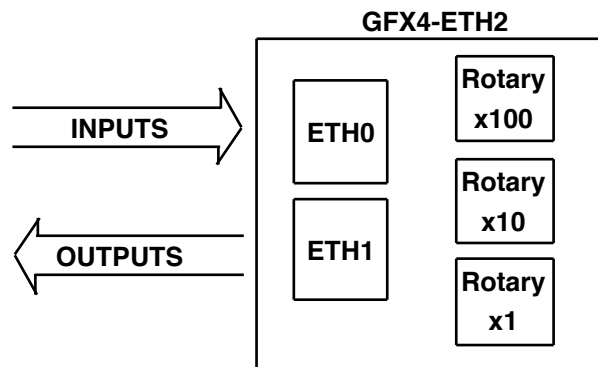

4 · CONNECTING HOST DEVICES

The internal connection to the host devices is realized by a serial communication (by encapsulation of the information in a Modbus RTU protocol)

For a correct connection, some conditions must be verified:

- Connection speed is 19200 baud
- No parity
- 8 data bits
- modbus slaves must have node address from 1 to 20

In this connection, the slaves must be connected as shown in the figure.

Typical connections with GFX4 controllers:

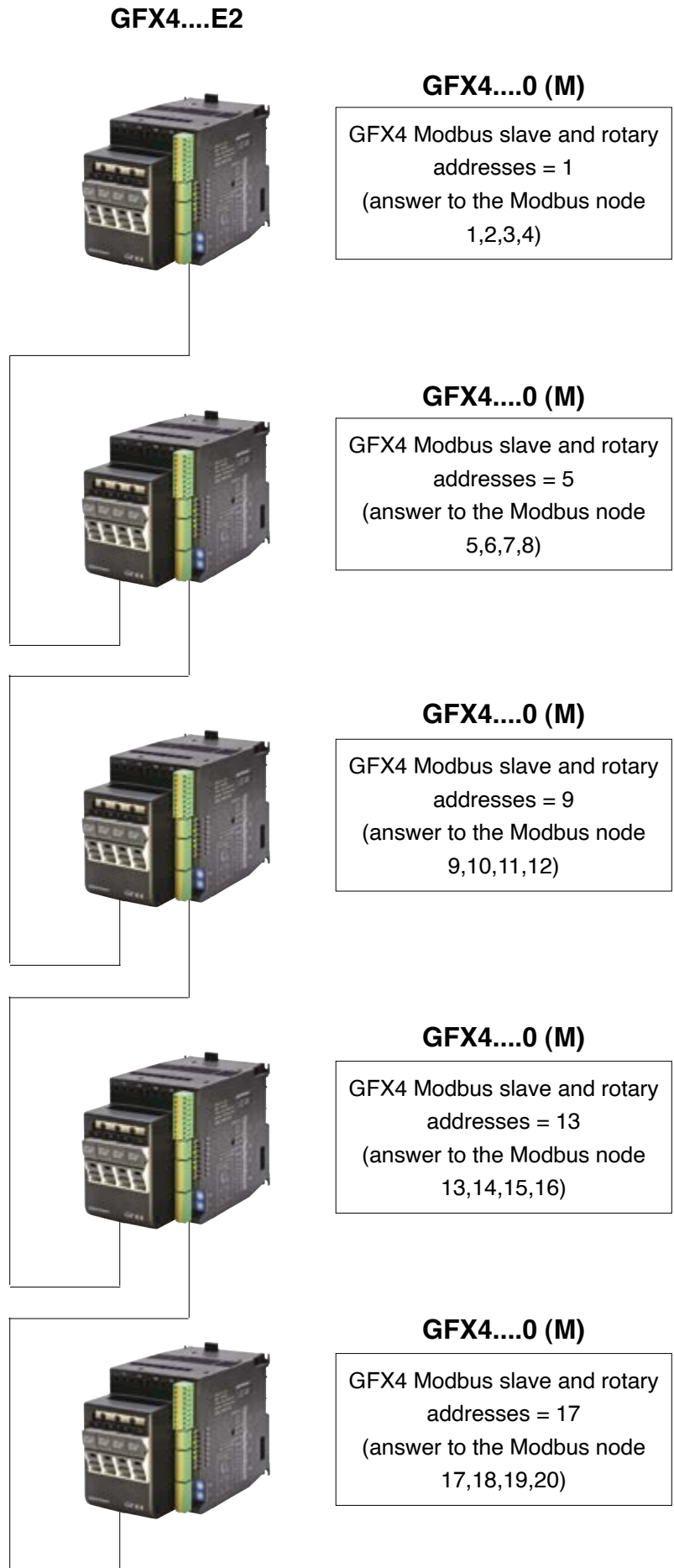

Serial communication time constraints in Modbus RTU

The following time constraints must be complied with in order to allow correct serial data exchange with the device:

Reading Word/Register parameters: Reading N consecutive parameters, with N from 1 to 16, requires a time of almost 50 ms. In this case the following read and write Modbus command, to the same node, must be sent after this interval time.

Writing Word/Register parameters: Writing N consecutive parameters, with N ranging from 1 to 16, if all values (maximum 16) on the device are updated, will take a time of: $50\text{ms} + N \times 80\text{ms}^{(*)}$ with N from 1 to 16. The times reported refer to the case in which the Baudrate of the serial line (parameter bAu Modbus address 45) is 19200.

(*) If STATUS_W parameters (Modbus address 305) are included in the write request and their value is different from the one currently present in the slave, the time required to write each one will be 240ms (instead of 80ms).

5 · DESCRIPTION OF DATA EXCHANGED BY GFX4-ETH2

The etherCAT slave can exchange two types of data:

- Configuration data
- Process data

This data must be characterized by the DDF file of the connected device; the significance of the data is known only by the applications that have to handle the flow of bits at high level.

GFX4-ETH2 is a bridge that lets the data enter. At the etherCAT level, the data flow from the Master/Slave and vice versa via the Acyclic Mailbox mechanism (slow data) or via cyclic channels for fast data.

The GFX4-ETH2 has a template to contain the structure of fast PDO data and a few simple primitives to handle SDOs.

The description of fast PDO data is contained in the objects that describe pdo mapping in reception/transmission and are identical to those used in CanOpen.

These objects are “compiled” by the master in startup phase with a start procedure in which the slave is “initialized” so that it is ready to transfer the necessary data..

6 · FROM DDF DESCRIPTION FILE TO DATA EXCHANGE

We will now see how to start from a DDF file and exchange data with a supervisor system.

In the following example, we use a GFX4 controller with optional “E2” board, the DDF GFX4_001.xml file describing the device, and a PC with Twincat Manager software by Beckhoff.

We see the content of the process data of the GFX4_001.xml file loaded in the GFX4 controller: it includes a network composed of 20 zones (the maximum that the GFX4-ETH2 can manage) characterized by 20 PDOs, one for each zone, plus a PDO in which a modbus Master communication channel is encapsulated in the process data; in detail, we see the table with the data mapped in the PDOs. See the GFX4 SW manual and the Modbus protocol manual for a description of the items in the table.

7 · PROCESS DATA STRUCTURE (PDO)

7.1. Description of pdos in reception for GFX4 with 20 zone

Nr. PDO in Rx	index	subindex	Size in bits	Comment
0x1600 (size 7 bytes) Optional fixed	0x5c00	0	8	Host request Modbus Trigger
	0x5c01	0	8	Host request Modbus Node
	0x5c02	0	8	Host request Modbus Function Code
	0x5c03	0	8	Host request Modbus Data 0
	0x5c04	0	8	Host request Modbus Data 0
	0x5c05	0	8	Host request Modbus Data 0
	0x5c06	0	8	Host request Modbus Data 0
0x1601 (size 6 bytes) Optional configurable	0x2010	1	16	Local Setpoin zone 1
	0x20fc	1	16	Manual output power zone 1
	0x2131	1	16	Controller status zone 1
0x1602 (size 6 bytes) Optional configurable	0x2010	2	16	Local Setpoin zone 2
	0x20fc	2	16	Manual output power zone 2
	0x2131	2	16	Controller status zone 2
0x1603 (size 6 bytes) Optional configurable	0x2010	3	16	Local Setpoin zone 3
	0x20fc	3	16	Manual output power zone 3
	0x2131	3	16	Controller status zone 3
0x1604 (size 6 bytes) Optional configurable	0x2010	4	16	Local Setpoin zone 4
	0x20fc	4	16	Manual output power zone 4
	0x2131	4	16	Controller status zone 4
0x1605 (size 6 bytes) Optional configurable	0x2010	5	16	Local Setpoin zone 5
	0x20fc	5	16	Manual output power zone 5
	0x2131	5	16	Controller status zone 5
0x1606 (size 6 bytes) Optional configurable	0x2010	6	16	Local Setpoin zone 6
	0x20fc	6	16	Manual output power zone 6
	0x2131	6	16	Controller status zone 6

7.1. Description of pdos in reception for GFX4 with 20 zone

Nr. PDO in Rx	index	subindex	Size in bits	Comment
0x1607 (size 6 bytes) Optional configurable	0x2010	7	16	Local Setpoint zone 7
	0x20fc	7	16	Manual output power zone 7
	0x2131	7	16	Controller status zone 7
0x1608 (size 6 bytes) Optional configurable	0x2010	8	16	Local Setpoint zone 8
	0x20fc	8	16	Manual output power zone 8
	0x2131	8	16	Controller status zone 8
0x1609 (size 6 bytes) Optional configurable	0x2010	9	16	Local Setpoint zone 9
	0x20fc	9	16	Manual output power zone 9
	0x2131	9	16	Controller status zone 9
0x160a (size 6 bytes) Optional configurable	0x2010	10	16	Local Setpoint zone 10
	0x20fc	10	16	Manual output power zone 10
	0x2131	10	16	Controller status zone 10
0x160b (size 6 bytes) Optional configurable	0x2010	11	16	Local Setpoint zone 11
	0x20fc	11	16	Manual output power zone 11
	0x2131	11	16	Controller status zone 11
0x160c (size 6 bytes) Optional configurable	0x2010	12	16	Local Setpoint zone 12
	0x20fc	12	16	Manual output power zone 12
	0x2131	12	16	Controller status zone 12
0x160d (size 6 bytes) Optional configurable	0x2010	13	16	Local Setpoint zone 13
	0x20fc	13	16	Manual output power zone 13
	0x2131	13	16	Controller status zone 13
0x160e (size 6 bytes) Optional configurable	0x2010	14	16	Local Setpoint zone 14
	0x20fc	14	16	Manual output power zone 14
	0x2131	14	16	Controller status zone 14
0x160f (size 6 bytes) Optional configurable	0x2010	15	16	Local Setpoint zone 15
	0x20fc	15	16	Manual output power zone 15
	0x2131	15	16	Controller status zone 15

7.1. Description of pdos in reception for GFX4 with 20 zone

Nr. PDO in Rx	index	subindex	Size in bits	Comment
0x1610 (size 6 bytes) Optional configurable	0x2010	16	16	Local Setpoin zone 16
	0x20fc	16	16	Manual output power zone 16
	0x2131	16	16	Controller status zone 16
0x1611 (size 6 bytes) Optional configurable	0x2010	17	16	Local Setpoin zone 17
	0x20fc	17	16	Manual output power zone 17
	0x2131	17	16	Controller status zone 17
0x1612 (size 6 bytes) Optional configurable	0x2010	18	16	Local Setpoin zone 18
	0x20fc	18	16	Manual output power zone 18
	0x2131	18	16	Controller status zone 18
0x1613 (size 6 bytes) Optional configurable	0x2010	19	16	Local Setpoin zone 19
	0x20fc	19	16	Manual output power zone 19
	0x2131	19	16	Controller status zone 19
0x1614 (size 6 bytes) Optional configurable	0x2010	20	16	Local Setpoin zone 20
	0x20fc	20	16	Manual output power zone 20
	0x2131	20	16	Controller status zone 20
TOTAL PDOs IN RECEPTION = 127 BYTES				

7.2. Description of pdos in transmission for GFX4 with 20 zone

Nr. PDO in Tx	index	subindex	Size in bits	Comment
0x1a00 (size 7 bytes) Optional fixed	0x5c00	0	8	Host response Modbus Trigger
	0x5c01	0	8	Host response Modbus Node
	0x5c02	0	8	Host response Modbus Function Code
	0x5c03	0	8	Host response Modbus Data 0
	0x5c04	0	8	Host response Modbus Data 0
	0x5c05	0	8	Host response Modbus Data 0
	0x5c06	0	8	Host response Modbus Data 0
0x1a01 (size 8 bytes) Optional configurable	0x3000	1	16	Process variable zone 1
	0x31d3	1	16	Controller status zone 1
	0x3002	1	16	Output power zone 1
	0x31d4	1	16	Ammeter input On 1 zone 1
0x1a02 (size 8 bytes) Optional configurable	0x3000	2	16	Process variable zone 2
	0x31d3	2	16	Controller status zone 2
	0x3002	2	16	Output power zone 2
	0x31d4	2	16	Ammeter input On 1 zone 2
0x1a03 (size 8 bytes) Optional configurable	0x3000	3	16	Process variable zone 3
	0x31d3	3	16	Controller status zone 3
	0x3002	3	16	Output power zone 3
	0x31d4	3	16	Ammeter input On 1 zone 3
0x1a04 (size 8 bytes) Optional configurable	0x3000	4	16	Process variable zone 4
	0x31d3	4	16	Controller status zone 4
	0x3002	4	16	Output power zone 4
	0x31d4	4	16	Ammeter input On 1 zone 4

7.2. Description of pdos in transmission for GFX4 with 20 zone

Nr. PDO in Tx	index	subindex	Size in bits	Comment
0x1a05 (size 8 bytes) Optional configurable	0x3000	5	16	Process variable zone 5
	0x31d3	5	16	Controller status zone 5
	0x3002	5	16	Output power zone 5
	0x31d4	5	16	Ammeter input On 1 zone 5
0x1a06 (size 8 bytes) Optional configurable	0x3000	6	16	Process variable zone 6
	0x31d3	6	16	Controller status zone 6
	0x3002	6	16	Output power zone 6
	0x31d4	6	16	Ammeter input On 1 zone 6
0x1a07 (size 8 bytes) Optional configurable	0x3000	7	16	Process variable zone 7
	0x31d3	7	16	Controller status zone 7
	0x3002	7	16	Output power zone 7
	0x31d4	7	16	Ammeter input On 1 zone 7
0x1a08 (size 8 bytes) Optional configurable	0x3000	8	16	Process variable zone 8
	0x31d3	8	16	Controller status zone 8
	0x3002	8	16	Output power zone 8
	0x31d4	8	16	Ammeter input On 1 zone 8
0x1a09 (size 8 bytes) Optional configurable	0x3000	9	16	Process variable zone 9
	0x31d3	9	16	Controller status zone 9
	0x3002	9	16	Output power zone 9
	0x31d4	9	16	Ammeter input On 1 zone 9
0x1a0a (size 8 bytes) Optional configurable	0x3000	10	16	Process variable zone 10
	0x31d3	10	16	Controller status zone 10
	0x3002	10	16	Output power zone 10
	0x31d4	10	16	Ammeter input On 1 zone 10
0x1a0b (size 8 bytes) Optional configurable	0x3000	11	16	Process variable zone 11
	0x31d3	11	16	Controller status zone 11
	0x3002	11	16	Output power zone 11
	0x31d4	11	16	Ammeter input On 1 zone 11

7.2. Description of pdos in transmission for GFX4 with 20 zone

Nr. PDO in Tx	index	subindex	Size in bits	Comment
0x1a0c (size 8 bytes) Optional configurable	0x3000	12	16	Process variable zone 12
	0x31d3	12	16	Controller status zone 12
	0x3002	12	16	Output power zone 12
	0x31d4	12	16	Ammeter input On 1 zone 12
0x1a0d (size 8 bytes) Optional configurable	0x3000	13	16	Process variable zone 13
	0x31d3	13	16	Controller status zone 13
	0x3002	13	16	Output power zone 13
	0x31d4	13	16	Ammeter input On 1 zone 13
0x1a0e (size 8 bytes) Optional configurable	0x3000	14	16	Process variable zone 14
	0x31d3	14	16	Controller status zone 14
	0x3002	14	16	Output power zone 14
	0x31d4	14	16	Ammeter input On 1 zone 14
0x1a0f (size 8 bytes) Optional configurable	0x3000	15	16	Process variable zone 15
	0x31d3	15	16	Controller status zone 15
	0x3002	15	16	Output power zone 15
	0x31d4	15	16	Ammeter input On 1 zone 15
0x1a10 (size 8 bytes) Optional configurable	0x3000	16	16	Process variable zone 16
	0x31d3	16	16	Controller status zone 16
	0x3002	16	16	Output power zone 16
	0x31d4	16	16	Ammeter input On 1 zone 16
0x1a11 (size 8 bytes) Optional configurable	0x3000	17	16	Process variable zone 17
	0x31d3	17	16	Controller status zone 17
	0x3002	17	16	Output power zone 17
	0x31d4	17	16	Ammeter input On 1 zone 17
0x1a12 (size 8 bytes) Optional configurable	0x3000	18	16	Process variable zone 18
	0x31d3	18	16	Controller status zone 18
	0x3002	18	16	Output power zone 18
	0x31d4	18	16	Ammeter input On 1 zone 18

7.2. Description of pdos in transmission for GFX4 with 20 zone

Nr. PDO in Tx	index	subindex	Size in bits	Comment
0x1a13 (size 8 bytes) Optional configurable	0x3000	19	16	Process variable zone 19
	0x31d3	19	16	Controller status zone 19
	0x3002	19	16	Output power zone 19
	0x31d4	19	16	Ammeter input On 1 zone 19
0x1a14 (size 8 bytes) Optional configurable	0x3000	20	16	Process variable zone 20
	0x31d3	20	16	Controller status zone 20
	0x3002	20	16	Output power zone 20
	0x31d4	20	16	Ammeter input On 1 zone 20
TOTAL PDOs IN TRANSMISSION = 167 BYTES				

The xml file also contains the initialization of the 0x5c07 object, which can have the following meanings:

Safe Fault Mode Object in case of absence of network link			
Index	Subindex	Admitted values	Description
0x5c07	0	0 (default)	No action
		1	Controllers Software OFF
		2	Controllers in manual
		3	Sets value Sp2

8 · OBJECT DICTIONARY (SDO)

8.1. GFX4

Index (Hex)	Sub Index	Description	Data Type	Acc.	Add. (Dec)
1000		Device Type	uns16	ro	-
1008		Manufacturer device name	uns16	ro	-
1009		Manufacturer Hardware version	uns16	ro	-
100a		Manufacturer Software version	uns16	ro	-
1018	0÷4	Identity Object	uns16	ro	-
1600	0÷n (1)	1st Receive PDO Mapping	uns16	ro	-
1601	0÷n (1)	2nd Receive PDO Mapping	uns16	rw	-
1602	0÷n (1)	3rd Receive PDO Mapping	uns16	rw	-
1603	0÷n (1)	4th Receive PDO Mapping	uns16	rw	-
1604	0÷n (1)	5th Receive PDO Mapping	uns16	rw	-
1605	0÷n (1)	6th Receive PDO Mapping	uns16	rw	-
1606	0÷n (1)	7th Receive PDO Mapping	uns16	rw	-
1607	0÷n (1)	8th Receive PDO Mapping	uns16	rw	-
1608	0÷n (1)	9th Receive PDO Mapping	uns16	rw	-
1609	0÷n (1)	10th Receive PDO Mapping	uns16	rw	-
160A	0÷n (1)	11th Receive PDO Mapping	uns16	rw	-
160B	0÷n (1)	12th Receive PDO Mapping	uns16	rw	-
160C	0÷n (1)	13th Receive PDO Mapping	uns16	rw	-
160D	0÷n (1)	14th Receive PDO Mapping	uns16	rw	-
160E	0÷n (1)	15th Receive PDO Mapping	uns16	rw	-
160F	0÷n (1)	16th Receive PDO Mapping	uns16	rw	-
1610	0÷n (1)	17th Receive PDO Mapping	uns16	rw	-
1611	0÷n (1)	18th Receive PDO Mapping	uns16	rw	-
1612	0÷n (1)	19th Receive PDO Mapping	uns16	rw	-
1613	0÷n (1)	20th Receive PDO Mapping	uns16	rw	-
1614	0÷n (1)	21th Receive PDO Mapping	uns16	rw	-
1A00	0÷n (1)	1st Transmit PDO Mapping	uns16	ro	-
1A01	0÷n (1)	2nd Transmit PDO Mapping	uns16	rw	-
1A02	0÷n (1)	3rd Transmit PDO Mapping	uns16	rw	-
1A03	0÷n (1)	4th Transmit PDO Mapping	uns16	rw	-
1A04	0÷n (1)	5th Transmit PDO Mapping	uns16	rw	-
1A05	0÷n (1)	6th Transmit PDO Mapping	uns16	rw	-
1A06	0÷n (1)	7th Transmit PDO Mapping	uns16	rw	-
1A07	0÷n (1)	8th Transmit PDO Mapping	uns16	rw	-
1A08	0÷n (1)	9th Transmit PDO Mapping	uns16	rw	-
1A09	0÷n (1)	10th Transmit PDO Mapping	uns16	rw	-
1A0A	0÷n (1)	11th Transmit PDO Mapping	uns16	rw	-
1A0B	0÷n (1)	12th Transmit PDO Mapping	uns16	rw	-
1A0C	0÷n (1)	13th Transmit PDO Mapping	uns16	rw	-
1A0D	0÷n (1)	14th Transmit PDO Mapping	uns16	rw	-
1A0E	0÷n (1)	15th Transmit PDO Mapping	uns16	rw	-
1A0F	0÷n (1)	16th Transmit PDO Mapping	uns16	rw	-
1A10	0÷n (1)	17th Transmit PDO Mapping	uns16	rw	-
1A11	0÷n (1)	18th Transmit PDO Mapping	uns16	rw	-
1A12	0÷n (1)	19th Transmit PDO Mapping	uns16	rw	-
1A13	0÷n (1)	20th Transmit PDO Mapping	uns16	rw	-
1A14	0÷n (1)	21th Transmit PDO Mapping	uns16	rw	-

8.1. GFX4

Index (Hex)	Sub Index	Description	Data Type	Acc.	Add. (Dec)
2005	0÷20 (2)	Heating proportional band	uns16	rw	5
2006	0÷20 (2)	Cooling proportional band	uns16	rw	6
2007	0÷20 (2)	Heating integral time	uns16	rw	7
2008	0÷20 (2)	Heating derivative time	uns16	rw	8
2009	0÷20 (2)	Cycle time Out1 (fast)	uns16	rw	9
200A	0÷20 (2)	Scale minimum limit	int16	rw	10
200B	0÷20 (2)	Scale maximum limit	int16	rw	11
200C	0÷20 (2)	Alarm 1 set (if realitve)	int16	rw	12
200D	0÷20 (2)	Alarm 2 set (if realitve)	int16	rw	13
200E	0÷20 (2)	Alarm 3 set (if realitve)	int16	rw	14
2010	0÷20 (2)	Local setpoint	int16	rw	16
2012	0÷20 (2)	Remote setpoint type	uns16	rw	18
2014	0÷20 (2)	Lower limit for setting setpoint	int16	rw	20
2015	0÷20 (2)	Upper limit for setting setpoint	int16	rw	21
2016	0÷20 (2)	Set gradient	uns16	rw	22
2017	0÷20 (2)	Main input offset correction	int16	rw	23
2018	0÷20 (2)	Digital filter on Main input	int16	rw	24
201B	0÷20 (2)	Hysteresis alarm1	int16	rw	27
201E	0÷20 (2)	Hysteresis alarm2	int16	rw	30
201F	0÷20 (2)	Enabling Selftuning,Autotuning,Softstart	uns16	rw	31
2027	0÷20 (2)	SetPoint for cooling relative to Heating	int16	rw	39
202A	0÷20 (2)	Heating maximum power limit	uns16	rw	42
202B	0÷20 (2)	Cooling maximum power limit	uns16	rw	43
202C	0÷20 (2)	Waiting time for LBA alarm intervention	uns16	rw	44
202D	0÷20 (2)	Baud rate selection of serial1	uns16	rw	45
202F	0÷20 (2)	Parity selection of serial1	uns16	rw	47
2035	0÷20 (2)	Hysteresis alarm 3	int16	rw	53
2036	0÷20 (2)	Alarm type 3	uns16	rw	54
2037	0÷20 (2)	Alarm HB input1	uns16	rw	55
2038	0÷20 (2)	Waiting time for HB alarm intervention	uns16	rw	56
2039	0÷20 (2)	Alarm type HB	uns16	rw	57
203A	0÷20 (2)	Alarm 4 set (if realitve)	int16	rw	58
203B	0÷20 (2)	Hysteresis alarm 4	int16	rw	59
204C	0÷20 (2)	Cooling integral time	uns16	rw	76
204D	0÷20 (2)	Cooling derivative time	uns16	rw	77
204E	0÷20 (2)	Manual reset	int16	rw	78
204F	0÷20 (2)	Antireset	uns16	rw	79
2050	0÷20 (2)	Feedforward	int16	rw	80
2056	0÷20 (2)	Custom scale point0	int16	rw	86
2057	0÷20 (2)	Custom scale point1	int16	rw	87
2058	0÷20 (2)	Custom scale point2	int16	rw	88
2059	0÷20 (2)	Custom scale point3	int16	rw	89
205A	0÷20 (2)	Custom scale point4	int16	rw	90
205B	0÷20 (2)	Custom scale point5	int16	rw	91
205C	0÷20 (2)	Custom scale point6	int16	rw	92
205D	0÷20 (2)	Custom scale point7	int16	rw	93
205E	0÷20 (2)	Custom scale point8	int16	rw	94
205F	0÷20 (2)	Custom scale point9	int16	rw	95

8.1. GFX4

Index (Hex)	Sub Index	Description	Data Type	Acc.	Add. (Dec)
2060	0÷20 ⁽²⁾	Custom scale point10	int16	rw	96
2061	0÷20 ⁽²⁾	Custom scale point11	int16	rw	97
2062	0÷20 ⁽²⁾	Custom scale point12	int16	rw	98
2063	0÷20 ⁽²⁾	Custom scale point13	int16	rw	99
2064	0÷20 ⁽²⁾	Custom scale point14	int16	rw	100
2065	0÷20 ⁽²⁾	Custom scale point15	int16	rw	101
2066	0÷20 ⁽²⁾	Custom scale point16	int16	rw	102
2067	0÷20 ⁽²⁾	Custom scale point17	int16	rw	103
2068	0÷20 ⁽²⁾	Custom scale point18	int16	rw	104
2069	0÷20 ⁽²⁾	Custom scale point19	int16	rw	105
206A	0÷20 ⁽²⁾	Custom scale point20	int16	rw	106
206B	0÷20 ⁽²⁾	Custom scale point21	int16	rw	107
206C	0÷20 ⁽²⁾	Custom scale point22	int16	rw	108
206D	0÷20 ⁽²⁾	Custom scale point23	int16	rw	109
206E	0÷20 ⁽²⁾	Custom scale point24	int16	rw	110
206F	0÷20 ⁽²⁾	Custom scale point25	int16	rw	111
2070	0÷20 ⁽²⁾	Custom scale point26	int16	rw	112
2071	0÷20 ⁽²⁾	Custom scale point27	int16	rw	113
2072	0÷20 ⁽²⁾	Custom scale point28	int16	rw	114
2073	0÷20 ⁽²⁾	Custom scale point29	int16	rw	115
2074	0÷20 ⁽²⁾	Custom scale point30	int16	rw	116
2075	0÷20 ⁽²⁾	Custom scale point31	int16	rw	117
2076	0÷20 ⁽²⁾	Custom scale point32	int16	rw	118
2077	0÷20 ⁽²⁾	Power limit for LBA alarm	int16	rw	119
208C	0÷20 ⁽²⁾	Digital input function	uns16	rw	140
209F	0÷20 ⁽²⁾	Cycle time Out2 (fast)	uns16	rw	159
20A0	0÷20 ⁽²⁾	RL.1 allocation of reference signal	uns16	rw	160
20A3	0÷20 ⁽²⁾	RL.2 allocation of reference signal	uns16	rw	163
20A6	0÷20 ⁽²⁾	RL.3 allocation of reference signal	uns16	rw	166
20AA	0÷20 ⁽²⁾	RL.4 allocation of reference signal	uns16	rw	170
20AB	0÷20 ⁽²⁾	RL.5 allocation of reference signal	uns16	rw	171
20AC	0÷20 ⁽²⁾	RL.6 allocation of reference signal	uns16	rw	172
20B3	0÷20 ⁽²⁾	Main input digital filter	uns16	rw	179
20B4	0÷20 ⁽²⁾	Control type	uns16	rw	180
20B5	0÷20 ⁽²⁾	Auxiliary analogue input function	uns16	rw	181
20BF	0÷20 ⁽²⁾	Hardware configuration1	uns16	rw	191
20C2	0÷20 ⁽²⁾	Probe type for auxiliary input selection	uns16	rw	194
20C3	0÷20 ⁽²⁾	Select number of enabled alarms	uns16	rw	195
20C5	0÷20 ⁽²⁾	Function of status led RUN	uns16	rw	197
20D7	0÷20 ⁽²⁾	Select signal for alarm1	uns16	rw	215
20D8	0÷20 ⁽²⁾	Select signal for alarm2	uns16	rw	216
20D9	0÷20 ⁽²⁾	Select signal for alarm3	uns16	rw	217
20DA	0÷20 ⁽²⁾	Select signal for alarm4	uns16	rw	218
20DB	0÷20 ⁽²⁾	TA inputs digital filter	uns16	rw	219
20DC	0÷20 ⁽²⁾	Offset correction for TA1 input	int16	rw	220
20E0	0÷20 ⁽²⁾	Virtual instrument inputs	uns16	rw	224
20E1	0÷20 ⁽²⁾	Virtual instrument outputs	uns16	rw	225
20E4	0÷20 ⁽²⁾	Power output in fault condition	int16	rw	228

8.1. GFX4

Index (Hex)	Sub Index	Description	Data Type	Acc.	Add. (Dec)
20E5	0÷20 (2)	Fault action	uns16	rw	229
20E6	0÷20 (2)	Setpoint1	int16	rw	230
20E7	0÷20 (2)	Setpoint2	int16	rw	231
20FA	0÷20 (2)	Remote setpoint from serial line	uns16	rw	250
20FC	0÷20 (2)	Manual Output power	int16	rw	252
2103	0÷20 (2)	Auxiliary set gradient for SP2	uns16	rw	259
2104	0÷20 (2)	Power alarm delay time	uns16	rw	260
2105	0÷20 (2)	Steady band (hot runners)	uns16	rw	261
2106	0÷20 (2)	Power alarm band (hot runners)	uns16	rw	262
2107	0÷20 (2)	Set point soft start (hot runners)	int16	rw	263
2108	0÷20 (2)	Soft start power	int16	rw	264
2109	0÷20 (2)	Hot	uns16	rw	265
2125	0÷20 (2)	Custom scale point33	int16	rw	293
2126	0÷20 (2)	Custom scale point34	int16	rw	294
2127	0÷20 (2)	Custom scale point35	int16	rw	295
2131	0÷20 (2)	Controller status	uns16	rw	305
2158	0÷20 (2)	Digital output	uns16	rw	344
215B	0÷20 (2)	Analog input1	int16	rw	347
215C	0÷20 (2)	Analog input2	int16	rw	348
2190	0÷20 (2)	Probe Type	uns16	rw	400
2193	0÷20 (2)	Decimal point position	uns16	rw	403
2194	0÷20 (2)	Auxiliary input minimum range	int16	rw	404
2195	0÷20 (2)	TA1 input maximum scale limit (for GFX4IR	uns16	rw	405
2196	0÷20 (2)	Alarm type1	uns16	rw	406
2197	0÷20 (2)	Alarm type2	uns16	rw	407
2198	0÷20 (2)	Alarm type3	uns16	rw	408
2199	0÷20 (2)	Alarm type4	uns16	rw	409
219A	0÷20 (2)	Auxiliary input TV scale maximum limit	uns16	rw	410
219B	0÷20 (2)	Auxiliary input TV offset correction	int16	rw	411
219C	0÷20 (2)	TV inputs digital filter	uns16	rw	412
219D	0÷20 (2)	Auxiliary input maximum range TA2 of	uns16	rw	413
219E	0÷20 (2)	Auxiliary input maximum range TA3 of	uns16	rw	414
219F	0÷20 (2)	Auxiliary input offset correction TA2 of	int16	rw	415
21A0	0÷20 (2)	Auxiliary input offset correction TA2 of	int16	rw	416
21A1	0÷20 (2)	Auxiliary input maximum range TV2 of	uns16	rw	417
21A2	0÷20 (2)	Auxiliary input maximum range TV3 of	uns16	rw	418
21A3	0÷20 (2)	Auxiliary input offset correction TV2 of	int16	rw	419
21A4	0÷20 (2)	Auxiliary input offset correction TV3 of	int16	rw	420
21F6	0÷20 (2)	Alarm HB input2	uns16	rw	502
21F7	0÷20 (2)	Alarm HB input3	uns16	rw	503
21F9	0÷20 (2)	Reference voltage for manual power correction	uns16	rw	505
21FA	0÷20 (2)	Manual power correction	uns16	rw	506
2201	0÷20 (2)	Cooling medium	uns16	rw	513
2204	0÷20 (2)	Reset power	int16	rw	516
2205	0÷20 (2)	Power set (hot runners)	int16	rw	517
225B	0÷20 (2)	Auxiliary input max scale	int16	rw	603
225C	0÷20 (2)	Auxiliary input digital filter	uns16	rw	604
225D	0÷20 (2)	Auxiliary input offset correction	int16	rw	605

8.1. GFX4

Index (Hex)	Sub Index	Description	Data Type	Acc.	Add. (Dec)
225F	0÷20 (2)	Allocation of output OUT1	uns16	rw	607
2260	0÷20 (2)	Allocation of output OUT2	uns16	rw	608
2261	0÷20 (2)	Allocation of output OUT3	uns16	rw	609
2262	0÷20 (2)	Allocation of output OUT4	uns16	rw	610
2263	0÷20 (2)	Allocation of output OUT5	uns16	rw	611
2264	0÷20 (2)	Allocation of output OUT6	uns16	rw	612
2265	0÷20 (2)	Allocation of output OUT7	uns16	rw	613
2266	0÷20 (2)	Allocation of output OUT8	uns16	rw	614
2267	0÷20 (2)	Allocation of output OUT9	uns16	rw	615
2268	0÷20 (2)	Allocation of output OUT10	uns16	rw	616
2269	0÷20 (2)	Selection of zone process variable / reference power	uns16	rw	617
226A	0÷20 (2)	Allocation of digital inpt 2 status	uns16	rw	618
2275	0÷20 (2)	Minimum no-conduction time for restart the phase softstart	uns16	rw	629
2276	0÷20 (2)	Max phase softstart	uns16	rw	630
2294	0÷20 (2)	Hardware configuration 2:diagnostic alarms	uns16	rw	660
2295	0÷20 (2)	Frequency for alarms: SCR_SHORT and NO_CURRENT	uns16	rw	661
2296	0÷20 (2)	Time filter for alarms: NO_VOLTAGE,SCR_OPEN,NO_CURRENT	uns16	rw	662
2297	0÷20 (2)	Min power for NO_CURRENT alarm	uns16	rw	663
22A5	0÷20 (2)	Auxiliary input decimal point position	uns16	rw	677
22A8	0÷20 (2)	Heuristic power managing enable	uns16	rw	678
22A9	0÷20 (2)	Heuristic power managing max current	uns16	rw	679
22AA	0÷20 (2)	Heterogeneous power managing enable	uns16	rw	680
22AB	0÷20 (2)	Heterogeneous power managing max current	uns16	rw	681
22AD	0÷20 (2)	Ammeter input serial	uns16	rw	685
22BB	0÷20 (2)	Power-on mode	uns16	rw	699
22BC	0÷20 (2)	Software off mode	uns16	rw	700
3000	0÷20 (2)	Process Value	int16	ro	0
3001	0÷20 (2)	Active SetPoint	int16	ro	1
3002	0÷20 (2)	Output power	int16	ro	2
3004	0÷20 (2)	Deviation	uns16	ro	4
3055	0÷20 (2)	Self-Diagnostic error code	uns16	ro	85
307A	0÷20 (2)	Software Version	uns16	ro	122
308B	0÷20 (2)	TA1 input value	uns16	ro	139
30BE	0÷20 (2)	Hardware configuration	uns16	ro	190
30E3	0÷20 (2)	Ammeter input1	uns16	ro	227
30E8	0÷20 (2)	Voltmetric input1	int16	ro	228
3128	0÷20 (2)	Self/autotuning status	uns16	ro	296
3134	0÷20 (2)	Output rL.x X_OUTVAL status	uns16	ro	308
313B	0÷20 (2)	Frequency	uns16	ro	315
313D	0÷20 (2)	Digital input status	uns16	ro	317
313F	0÷20 (2)	Digital output status	uns16	ro	319
3142	0÷20 (2)	Voltm. input1 f.	uns16	ro	322
31D3	0÷20 (2)	Controller Status	uns16	ro	467
31D4	0÷20 (2)	Ammeter Input 1 On	uns16	ro	468
31D5	0÷20 (2)	Alarm HB Status	uns16	ro	469
31EA	0÷20 (2)	Ammeter Input 2	uns16	ro	490

8.1. GFX4

Index (Hex)	Sub Index	Description	Data Type	Acc.	Add. (Dec)
31EB	0÷20 ⁽²⁾	Ammeter Input 3	uns16	ro	491
31EC	0÷20 ⁽²⁾	Voltmetric input 2	uns16	ro	492
31ED	0÷20 ⁽²⁾	Voltmetric input 3	uns16	ro	493
31EE	0÷20 ⁽²⁾	Ammeter input2 f.	uns16	ro	494
31EF	0÷20 ⁽²⁾	Ammeter input3 f.	uns16	ro	495
31F0	0÷20 ⁽²⁾	Voltm. input2 f.	uns16	ro	496
31F1	0÷20 ⁽²⁾	Voltm. input3 f.	uns16	ro	497
31F2	0÷20 ⁽²⁾	Ammeter Input 2 On	uns16	ro	498
31F3	0÷20 ⁽²⁾	Ammeter Input 3 On	uns16	ro	499
31F8	0÷20 ⁽²⁾	Alarm status HB	uns16	ro	504
31FB	0÷20 ⁽²⁾	Power saved in ON-OFF=OFF	int16	ro	507
31FD	0÷20 ⁽²⁾	GFX 15A fuse status	uns16	ro	509
3200	0÷20 ⁽²⁾	Alstate	uns16	ro	512
325A	0÷20 ⁽²⁾	Auxiliary Input	int16	ro	602
325E	0÷20 ⁽²⁾	Auxiliary Input self-diagnostic error code	uns16	ro	606
3278	0÷20 ⁽²⁾	Status_strumento2	uns16	ro	632
3279	0÷20 ⁽²⁾	Status_strumento3	uns16	ro	633
327A	0÷20 ⁽²⁾	Status_strumento4	uns16	ro	634
328F	0÷20 ⁽²⁾	INPTC	uns16	ro	655
3298	0÷20 ⁽²⁾	Output out.x status MASKOUT	uns16	ro	664
3299	0÷20 ⁽²⁾	IN_TA_ON_DIAG	uns16	ro	665
329A	0÷20 ⁽²⁾	IN_TA_OFF_DIAG	uns16	ro	666
329B	0÷20 ⁽²⁾	IN_TV_ON_DIAG	uns16	ro	667
329C	0÷20 ⁽²⁾	IN_TV_OFF_DIAG	uns16	ro	668
32F4	0÷20 ⁽²⁾	Ammeter input1 f.	int16	ro	756
5C07	0	Safe Fault mode	uns16	ro	

Note:

(1) Depending on number of PDOs you intend to use

(2) Depending on number of connected zone

8.2. GFX4-IR

Index (Hex)	Sub Index	Description	Data Type	Acc.	Add. (Dec)
1000	0	Device Type	uns16	ro	-
1008	0	Manufacturer device name	uns16	ro	-
1009	0	Manufacturer Hardware version	uns16	ro	-
100A	0	Manufacturer Software version	uns16	ro	-
1018	0÷4	Identity Object	uns16	ro	-
1600	0÷n (1)	1st Receive PDO Mapping	uns16	ro	-
1601	0÷n (1)	2nd Receive PDO Mapping	uns16	rw	-
1602	0÷n (1)	3rd Receive PDO Mapping	uns16	rw	-
1603	0÷n (1)	4th Receive PDO Mapping	uns16	rw	-
1604	0÷n (1)	5th Receive PDO Mapping	uns16	rw	-
1605	0÷n (1)	6th Receive PDO Mapping	uns16	rw	-
1606	0÷n (1)	7th Receive PDO Mapping	uns16	rw	-
1607	0÷n (1)	8th Receive PDO Mapping	uns16	rw	-
1608	0÷n (1)	9th Receive PDO Mapping	uns16	rw	-
1609	0÷n (1)	10th Receive PDO Mapping	uns16	rw	-
160A	0÷n (1)	11th Receive PDO Mapping	uns16	rw	-
160B	0÷n (1)	12th Receive PDO Mapping	uns16	rw	-
160C	0÷n (1)	13th Receive PDO Mapping	uns16	rw	-
160D	0÷n (1)	14th Receive PDO Mapping	uns16	rw	-
160E	0÷n (1)	15th Receive PDO Mapping	uns16	rw	-
160F	0÷n (1)	16th Receive PDO Mapping	uns16	rw	-
1610	0÷n (1)	17th Receive PDO Mapping	uns16	rw	-
1611	0÷n (1)	18th Receive PDO Mapping	uns16	rw	-
1612	0÷n (1)	19th Receive PDO Mapping	uns16	rw	-
1613	0÷n (1)	20th Receive PDO Mapping	uns16	rw	-
1614	0÷n (1)	21th Receive PDO Mapping	uns16	rw	-
1A00	0÷n (1)	1st Transmit PDO Mapping	uns16	ro	-
1A01	0÷n (1)	2nd Transmit PDO Mapping	uns16	rw	-
1A02	0÷n (1)	3rd Transmit PDO Mapping	uns16	rw	-
1A03	0÷n (1)	4th Transmit PDO Mapping	uns16	rw	-
1A04	0÷n (1)	5th Transmit PDO Mapping	uns16	rw	-
1A05	0÷n (1)	6th Transmit PDO Mapping	uns16	rw	-
1A06	0÷n (1)	7th Transmit PDO Mapping	uns16	rw	-
1A07	0÷n (1)	8th Transmit PDO Mapping	uns16	rw	-
1A08	0÷n (1)	9th Transmit PDO Mapping	uns16	rw	-
1A09	0÷n (1)	10th Transmit PDO Mapping	uns16	rw	-
1A0A	0÷n (1)	11th Transmit PDO Mapping	uns16	rw	-
1A0B	0÷n (1)	12th Transmit PDO Mapping	uns16	rw	-
1A0C	0÷n (1)	13th Transmit PDO Mapping	uns16	rw	-
1A0D	0÷n (1)	14th Transmit PDO Mapping	uns16	rw	-
1A0E	0÷n (1)	15th Transmit PDO Mapping	uns16	rw	-
1A0F	0÷n (1)	16th Transmit PDO Mapping	uns16	rw	-
1A10	0÷n (1)	17th Transmit PDO Mapping	uns16	rw	-
1A11	0÷n (1)	18th Transmit PDO Mapping	uns16	rw	-
1A12	0÷n (1)	19th Transmit PDO Mapping	uns16	rw	-
1A13	0÷n (1)	20th Transmit PDO Mapping	uns16	rw	-
1A14	0÷n (1)	21th Transmit PDO Mapping	uns16	rw	-
2005	0÷20 (2)	Heating proportional band	uns16	rw	5

8.2. GFX4-IR

Index (Hex)	Sub Index	Description	Data Type	Acc.	Add. (Dec)
2006	0÷20 (2)	Cooling proportional band	uns16	rw	6
2007	0÷20 (2)	Heating integral time	uns16	rw	7
2008	0÷20 (2)	Heating derivative time	uns16	rw	8
2009	0÷20 (2)	Cycle time Out1 (fast)	uns16	rw	9
200A	0÷20 (2)	Scale minimum limit	int16	rw	10
200B	0÷20 (2)	Scale maximum limit	int16	rw	11
200C	0÷20 (2)	Alarm 1 set (if realitve)	int16	rw	12
200D	0÷20 (2)	Alarm 2 set (if realitve)	int16	rw	13
200E	0÷20 (2)	Alarm 3 set (if realitve)	int16	rw	14
2010	0÷20 (2)	Local setpoint	int16	rw	16
2012	0÷20 (2)	Remote setpoint type	uns16	rw	18
2014	0÷20 (2)	Lower limit for setting setpoint	int16	rw	20
2015	0÷20 (2)	Upper limit for setting setpoint	int16	rw	21
2016	0÷20 (2)	Set gradient	uns16	rw	22
2017	0÷20 (2)	Main input offset correction	int16	rw	23
2018	0÷20 (2)	Digital filter on Main input	int16	rw	24
201B	0÷20 (2)	Hysteresis alarm1	int16	rw	27
201E	0÷20 (2)	Hysteresis alarm2	int16	rw	30
201F	0÷20 (2)	Enabling Selftuning,Autotuning,Softstart	uns16	rw	31
2027	0÷20 (2)	SetPoint for cooling relative to Heating	int16	rw	39
202A	0÷20 (2)	Heating maximum power limit	uns16	rw	42
202B	0÷20 (2)	Cooling maximum power limit	uns16	rw	43
202C	0÷20 (2)	Waiting time for LBA alarm intervention	uns16	rw	44
202D	0÷20 (2)	Baud rate selection of serial1	uns16	rw	45
202F	0÷20 (2)	Parity selection of serial1	uns16	rw	47
2035	0÷20 (2)	Hysteresis alarm 3	int16	rw	53
2036	0÷20 (2)	Alarm type 3	uns16	rw	54
2037	0÷20 (2)	Alarm HB input1	uns16	rw	55
2038	0÷20 (2)	Waiting time for HB alarm intervention	uns16	rw	56
2039	0÷20 (2)	Alarm type HB	uns16	rw	57
203A	0÷20 (2)	Alarm 4 set (if realitve)	int16	rw	58
203B	0÷20 (2)	Hysteresis alarm 4	int16	rw	59
204C	0÷20 (2)	Cooling integral time	uns16	rw	76
204D	0÷20 (2)	Cooling derivative time	uns16	rw	77
204E	0÷20 (2)	Manual reset	int16	rw	78
204F	0÷20 (2)	Antireset	uns16	rw	79
2050	0÷20 (2)	Feedforward	int16	rw	80
2056	0÷20 (2)	Custom scale point0	int16	rw	86
2057	0÷20 (2)	Custom scale point1	int16	rw	87
2058	0÷20 (2)	Custom scale point2	int16	rw	88
2059	0÷20 (2)	Custom scale point3	int16	rw	89
205A	0÷20 (2)	Custom scale point4	int16	rw	90
205B	0÷20 (2)	Custom scale point5	int16	rw	91
205C	0÷20 (2)	Custom scale point6	int16	rw	92
205D	0÷20 (2)	Custom scale point7	int16	rw	93
205E	0÷20 (2)	Custom scale point8	int16	rw	94
205F	0÷20 (2)	Custom scale point9	int16	rw	95
2060	0÷20 (2)	Custom scale point10	int16	rw	96

8.2. GFX4-IR

Index (Hex)	Sub Index	Description	Data Type	Acc.	Add. (Dec)
2061	0÷20 (2)	Custom scale point11	int16	rw	97
2062	0÷20 (2)	Custom scale point12	int16	rw	98
2063	0÷20 (2)	Custom scale point13	int16	rw	99
2064	0÷20 (2)	Custom scale point14	int16	rw	100
2065	0÷20 (2)	Custom scale point15	int16	rw	101
2066	0÷20 (2)	Custom scale point16	int16	rw	102
2067	0÷20 (2)	Custom scale point17	int16	rw	103
2068	0÷20 (2)	Custom scale point18	int16	rw	104
2069	0÷20 (2)	Custom scale point19	int16	rw	105
206A	0÷20 (2)	Custom scale point20	int16	rw	106
206B	0÷20 (2)	Custom scale point21	int16	rw	107
206C	0÷20 (2)	Custom scale point22	int16	rw	108
206D	0÷20 (2)	Custom scale point23	int16	rw	109
206E	0÷20 (2)	Custom scale point24	int16	rw	110
206F	0÷20 (2)	Custom scale point25	int16	rw	111
2070	0÷20 (2)	Custom scale point26	int16	rw	112
2071	0÷20 (2)	Custom scale point27	int16	rw	113
2072	0÷20 (2)	Custom scale point28	int16	rw	114
2073	0÷20 (2)	Custom scale point29	int16	rw	115
2074	0÷20 (2)	Custom scale point30	int16	rw	116
2075	0÷20 (2)	Custom scale point31	int16	rw	117
2076	0÷20 (2)	Custom scale point32	int16	rw	118
2077	0÷20 (2)	Power limit for LBA alarm	int16	rw	119
208C	0÷20 (2)	Digital input function	uns16	rw	140
209F	0÷20 (2)	Cycle time Out2 (fast)	uns16	rw	159
20A0	0÷20 (2)	RL.1 allocation of reference signal	uns16	rw	160
20A3	0÷20 (2)	RL.2 allocation of reference signal	uns16	rw	163
20A6	0÷20 (2)	RL.3 allocation of reference signal	uns16	rw	166
20AA	0÷20 (2)	RL.4 allocation of reference signal	uns16	rw	170
20AB	0÷20 (2)	RL.5 allocation of reference signal	uns16	rw	171
20AC	0÷20 (2)	RL.6 allocation of reference signal	uns16	rw	172
20B3	0÷20 (2)	Main input digital filter	uns16	rw	179
20B4	0÷20 (2)	Control type	uns16	rw	180
20B5	0÷20 (2)	Auxiliary analogue input function	uns16	rw	181
20BF	0÷20 (2)	Hardware configuration1	uns16	rw	191
20C2	0÷20 (2)	Probe type for auxiliary input selection	uns16	rw	194
20C3	0÷20 (2)	Select number of enabled alarms	uns16	rw	195
20C5	0÷20 (2)	Function of status led RUN	uns16	rw	197
20D7	0÷20 (2)	Select signal for alarm1	uns16	rw	215
20D8	0÷20 (2)	Select signal for alarm2	uns16	rw	216
20D9	0÷20 (2)	Select signal for alarm3	uns16	rw	217
20DA	0÷20 (2)	Select signal for alarm4	uns16	rw	218
20DB	0÷20 (2)	TA inputs digital filter	uns16	rw	219
20DC	0÷20 (2)	Offset correction for TA1 input	int16	rw	220
20E0	0÷20 (2)	Virtual instrument inputs	uns16	rw	224
20E1	0÷20 (2)	Virtual instrument outputs	uns16	rw	225
20E4	0÷20 (2)	Power output in fault condition	int16	rw	228
20E5	0÷20 (2)	Fault action	uns16	rw	229

8.2. GFX4-IR

Index (Hex)	Sub Index	Description	Data Type	Acc.	Add. (Dec)
20E6	0÷20 (2)	Setpoint1	int16	rw	230
20E7	0÷20 (2)	Setpoint2	int16	rw	231
20FA	0÷20 (2)	Remote setpoint from serial line	uns16	rw	250
20FC	0÷20 (2)	Manual Output power	int16	rw	252
2103	0÷20 (2)	Auxiliary set gradient for SP2	uns16	rw	259
2104	0÷20 (2)	Power alarm delay time	uns16	rw	260
2105	0÷20 (2)	Steady band (hot runners)	uns16	rw	261
2106	0÷20 (2)	Power alarm band (hot runners)	uns16	rw	262
2107	0÷20 (2)	Set point soft start (hot runners)	int16	rw	263
2108	0÷20 (2)	Soft start power	int16	rw	264
2109	0÷20 (2)	Hot	uns16	rw	265
2125	0÷20 (2)	Custom scale point33	int16	rw	293
2126	0÷20 (2)	Custom scale point34	int16	rw	294
2127	0÷20 (2)	Custom scale point35	int16	rw	295
2131	0÷20 (2)	Controller status	uns16	rw	305
2158	0÷20 (2)	Digital output	uns16	rw	344
215B	0÷20 (2)	Analog input1	int16	rw	347
215C	0÷20 (2)	Analog input2	int16	rw	348
2190	0÷20 (2)	Probe Type	uns16	rw	400
2193	0÷20 (2)	Decimal point position	uns16	rw	403
2194	0÷20 (2)	Auxiliary input minimum range	int16	rw	404
2195	0÷20 (2)	TA1 input maximum scale limit (for GFX4IR	uns16	rw	405
2196	0÷20 (2)	Alarm type1	uns16	rw	406
2197	0÷20 (2)	Alarm type2	uns16	rw	407
2198	0÷20 (2)	Alarm type3	uns16	rw	408
2199	0÷20 (2)	Alarm type4	uns16	rw	409
219A	0÷20 (2)	Auxiliary input TV scale maximum limit	uns16	rw	410
219B	0÷20 (2)	Auxiliary input TV offset correction	int16	rw	411
219C	0÷20 (2)	TV inputs digital filter	uns16	rw	412
219D	0÷20 (2)	Auxiliary input maximum range TA2 of	uns16	rw	413
219E	0÷20 (2)	Auxiliary input maximum range TA3 of	uns16	rw	414
219F	0÷20 (2)	Auxiliary input offset correction TA2 of	int16	rw	415
21A0	0÷20 (2)	Auxiliary input offset correction TA2 of	int16	rw	416
21A1	0÷20 (2)	Auxiliary input maximum range TV2 of	uns16	rw	417
21A2	0÷20 (2)	Auxiliary input maximum range TV3 of	uns16	rw	418
21A3	0÷20 (2)	Auxiliary input offset correction TV2 of	int16	rw	419
21A4	0÷20 (2)	Auxiliary input offset correction TV3 of	int16	rw	420
21F6	0÷20 (2)	Alarm HB input2	uns16	rw	502
21F7	0÷20 (2)	Alarm HB input3	uns16	rw	503
21F9	0÷20 (2)	Reference voltage for manual power correction	uns16	rw	505
21FA	0÷20 (2)	Manual power correction	uns16	rw	506
2201	0÷20 (2)	Cooling medium	uns16	rw	513
2204	0÷20 (2)	Reset power	int16	rw	516
2205	0÷20 (2)	Power set (hot runners)	int16	rw	517
225B	0÷20 (2)	Auxiliary input max scale	int16	rw	603
225C	0÷20 (2)	Auxiliary input digital filter	uns16	rw	604
225D	0÷20 (2)	Auxiliary input offset correction	int16	rw	605
225F	0÷20 (2)	Allocation of output OUT1	uns16	rw	607

8.2. GFX4-IR

Index (Hex)	Sub Index	Description	Data Type	Acc.	Add. (Dec)
2260	0÷20 (2)	Allocation of output OUT2	uns16	rw	608
2261	0÷20 (2)	Allocation of output OUT3	uns16	rw	609
2262	0÷20 (2)	Allocation of output OUT4	uns16	rw	610
2263	0÷20 (2)	Allocation of output OUT5	uns16	rw	611
2264	0÷20 (2)	Allocation of output OUT6	uns16	rw	612
2265	0÷20 (2)	Allocation of output OUT7	uns16	rw	613
2266	0÷20 (2)	Allocation of output OUT8	uns16	rw	614
2267	0÷20 (2)	Allocation of output OUT9	uns16	rw	615
2268	0÷20 (2)	Allocation of output OUT10	uns16	rw	616
2269	0÷20 (2)	Selection of zone process variable / reference	uns16	rw	617
226A	0÷20 (2)	Allocation of digital inpt 2 status	uns16	rw	618
2275	0÷20 (2)	Minimum no-conduction time for restart	uns16	rw	629
2276	0÷20 (2)	Max phase softstart	uns16	rw	630
2294	0÷20 (2)	Hardware configuration 2:diagnostic alarms	uns16	rw	660
2295	0÷20 (2)	Frequency for alarms: SCR_SHORT and	uns16	rw	661
2296	0÷20 (2)	Time filter for alarms: NO_VOLTAGE,	uns16	rw	662
2297	0÷20 (2)	Min power for NO_CURRENT alarm	uns16	rw	663
22A5	0÷20 (2)	Auxiliary input decimal point position	uns16	rw	677
22A8	0÷20 (2)	Heuristic power managing enable	uns16	rw	680
22A9	0÷20 (2)	Heuristic power managing max current	uns16	rw	681
22AA	0÷20 (2)	Heterogeneous power managing enable	uns16	rw	682
22AB	0÷20 (2)	Heterogeneous power managing max current	uns16	rw	683
22AD	0÷20 (2)	Ammeter input serial	uns16	rw	685
22BB	0÷20 (2)	Power-on mode	uns16	rw	699
22BC	0÷20 (2)	Software off mode	uns16	rw	700
22BF	0÷20 (2)	Firing mode config	uns16	rw	703
22C0	0÷20 (2)	Number of minimum cycles in BF mode	uns16	rw	704
22C1	0÷20 (2)	Lenght of the phase softstart ramp	uns16	rw	705
22C2	0÷20 (2)	Max peak current during softstart	uns16	rw	706
22C3	0÷20 (2)	Max rms current during full working	uns16	rw	707
22C4	0÷20 (2)	Delay triggering	uns16	rw	708
22DA	0÷20 (2)	Feedback mode config	uns16	rw	730
22DB	0÷20 (2)	Max feedback voltage correction	uns16	rw	731
22DC	0÷20 (2)	Max feedback current correction	uns16	rw	732
22DD	0÷20 (2)	Max feedback power correction	uns16	rw	733
22DE	0÷20 (2)	feedback voltage correction	uns16	rw	734
22DF	0÷20 (2)	feedback current correction	uns16	rw	735
22E0	0÷20 (2)	feedback power correction	uns16	rw	736
22E1	0÷20 (2)	Current threshold percentage of the HB	uns16	rw	737
22E2	0÷20 (2)	Min no-conduction time for delay triggering	uns16	rw	738
22E4	0÷20 (2)	Feedback proportional band	uns16	rw	740
22E5	0÷20 (2)	Feedback speed response	uns16	rw	741
22E6	0÷20 (2)	TA input of HB calibration	uns16	rw	742
22E7	0÷20 (2)	Power of HB calibration	uns16	rw	743
22EA	0÷20 (2)	TA1 input min scale limit	uns16	rw	746
22EB	0÷20 (2)	TA2 input min scale limit	uns16	rw	747
22EC	0÷20 (2)	TA3 input min scale limit	uns16	rw	748
22F6	0÷20 (2)	TA input point 00 of HB calibration	uns16	rw	758

8.2. GFX4-IR

Index (Hex)	Sub Index	Description	Data Type	Acc.	Add. (Dec)
22F7	0÷20 (2)	TA input point 01 of HB calibration	uns16	rw	759
22F8	0÷20 (2)	TA input point 02 of HB calibration	uns16	rw	760
22F9	0÷20 (2)	TA input point 03 of HB calibration	uns16	rw	761
22FB	0÷20 (2)	Gradient for control output	uns16	rw	763
22FC	0÷20 (2)	Min firing output power	uns16	rw	764
22FD	0÷20 (2)	Output power %	uns16	rw	765
22FE	0÷20 (2)	Output power offset	int16	rw	766
3000	0÷20 (2)	Process Value	int16	ro	0
3001	0÷20 (2)	Active SetPoint	int16	ro	1
3002	0÷20 (2)	Output power	int16	ro	2
3004	0÷20 (2)	Deviation	uns16	ro	4
3055	0÷20 (2)	Self-Diagnostic error code	uns16	ro	85
307A	0÷20 (2)	Software Version	uns16	ro	122
308B	0÷20 (2)	TA1 input value	uns16	ro	139
30BE	0÷20 (2)	Hardware configuration	uns16	ro	190
30E3	0÷20 (2)	Ammeter input1	uns16	ro	227
30E8	0÷20 (2)	Voltmetric input1	int16	ro	232
3128	0÷20 (2)	Self/autotuning status	uns16	ro	296
3134	0÷20 (2)	Output rL.x X_OUTVAL status	uns16	ro	308
313B	0÷20 (2)	Frequency	uns16	ro	315
313D	0÷20 (2)	Digital input status	uns16	ro	317
313F	0÷20 (2)	Digital output status	uns16	ro	319
3142	0÷20 (2)	Voltm. input1 f.	uns16	ro	322
31D3	0÷20 (2)	Controller Status	uns16	ro	467
31D4	0÷20 (2)	Ammeter Input 1 On	uns16	ro	468
31D5	0÷20 (2)	Alarm HB Status	uns16	ro	469
31EA	0÷20 (2)	Ammeter Input 2	uns16	ro	490
31EB	0÷20 (2)	Ammeter Input 3	uns16	ro	491
31EC	0÷20 (2)	Voltmetric input 2	uns16	ro	492
31ED	0÷20 (2)	Voltmetric input 3	uns16	ro	493
31EE	0÷20 (2)	Ammeter input2 f.	uns16	ro	494
31EF	0÷20 (2)	Ammeter input3 f.	uns16	ro	495
31F0	0÷20 (2)	Voltm. input2 f.	uns16	ro	496
31F1	0÷20 (2)	Voltm. input3 f.	uns16	ro	497
31F2	0÷20 (2)	Ammeter Input 2 On	uns16	ro	498
31F3	0÷20 (2)	Ammeter Input 3 On	uns16	ro	499
31F8	0÷20 (2)	Alarm status HB	uns16	ro	504
31FB	0÷20 (2)	Power saved in ON-OFF=OFF	int16	ro	507
31FD	0÷20 (2)	GFX 15A fuse status	uns16	ro	509
3200	0÷20 (2)	Alstate	uns16	ro	512
325A	0÷20 (2)	Auxiliary Input	int16	ro	602
325E	0÷20 (2)	Auxiliary Input self-diagnostic error code	uns16	ro	606
3278	0÷20 (2)	Status_strumento2	uns16	ro	632
3279	0÷20 (2)	Status_strumento3	uns16	ro	633
327A	0÷20 (2)	Status_strumento4	uns16	ro	634
328F	0÷20 (2)	INPTC	uns16	ro	655
3298	0÷20 (2)	Output out.x status MASKOUT	uns16	ro	664
3299	0÷20 (2)	IN_TA_ON_DIAG	uns16	ro	665

8.2. GFX4-IR

Index (Hex)	Sub Index	Description	Data Type	Acc.	Add. (Dec)
329A	0÷20 ⁽²⁾	IN_TA_OFF_DIAG	uns16	ro	666
329B	0÷20 ⁽²⁾	IN_TV_ON_DIAG	uns16	ro	667
329C	0÷20 ⁽²⁾	IN_TV_OFF_DIAG	uns16	ro	668
32BE	0÷20 ⁽²⁾	Status5	uns16	ro	702
32C5	0÷20 ⁽²⁾	Peak current during softstart phase	uns16	ro	709
32C6	0÷20 ⁽²⁾	Phase-to-phasevoltage V21	uns16	ro	710
32C7	0÷20 ⁽²⁾	Phase-to-phasevoltage V32	uns16	ro	711
32C8	0÷20 ⁽²⁾	Phase-to-phasevoltage V13	uns16	ro	712
32C9	0÷20 ⁽²⁾	I.F21 Phase-to-phasevoltage F21	uns16	ro	713
32CA	0÷20 ⁽²⁾	I.F32 Phase-to-phasevoltage F32	uns16	ro	714
32CB	0÷20 ⁽²⁾	I.F13 Phase-to-phasevoltage F13	uns16	ro	715
32CC	0÷20 ⁽²⁾	Power Factor	uns16	ro	716
32CD	0÷20 ⁽²⁾	Lag.F	uns16	ro	717
32CE	0÷20 ⁽²⁾	Int_adc_peak	uns16	ro	718
32CF	0÷20 ⁽²⁾	Load Power	uns16	ro	719
32D0	0÷20 ⁽²⁾	3 Phase load power	uns16	ro	720
32E3	0÷20 ⁽²⁾	Feedback power correction	int16	ro	739
32E8	0÷20 ⁽²⁾	Current threshold for HB alarm	uns16	ro	744
32E9	0÷20 ⁽²⁾	Current power correction	uns16	ro	745
32ED	0÷20 ⁽²⁾	Load Impedence	uns16	ro	749
32EE	0÷20 ⁽²⁾	3-phase load impedence	uns16	ro	750
32EF	0÷20 ⁽²⁾	Load voltage	uns16	ro	751
32F0	0÷20 ⁽²⁾	3-phase load voltage	uns16	ro	752
32F1	0÷20 ⁽²⁾	Load current	uns16	ro	753
32F2	0÷20 ⁽²⁾	3-phase load current	uns16	ro	754
32F3	0÷20 ⁽²⁾	Phase angle power	uns16	ro	755
32F4	0÷20 ⁽²⁾	Ammeter input1 f.	int16	ro	756
5C07	0	Safe Fault mode	uns16	ro	

Note:

- (1) Depending on number of PDOs you intend to use
- (2) Depending on number of connected zone

8.3. Installation and configuration example with TwinCAT environment

After installing the TwinCAT SW in a computer equipped with a compatible ethernet controller (see the list of controllers compatible with the Beckhoff Information System > TwinCAT > TwinCAT System Manager > Reference > I/O Devices > EtherCAT(Direct Mode) > Supported network controller), run the following steps:

- Obtain the GFX4_001.xml/GFX4IR_001.xml file
- Relocate the file in the TwinCAT default directory c:\TwinCAT\Io\EtherCAT as shown in the figure

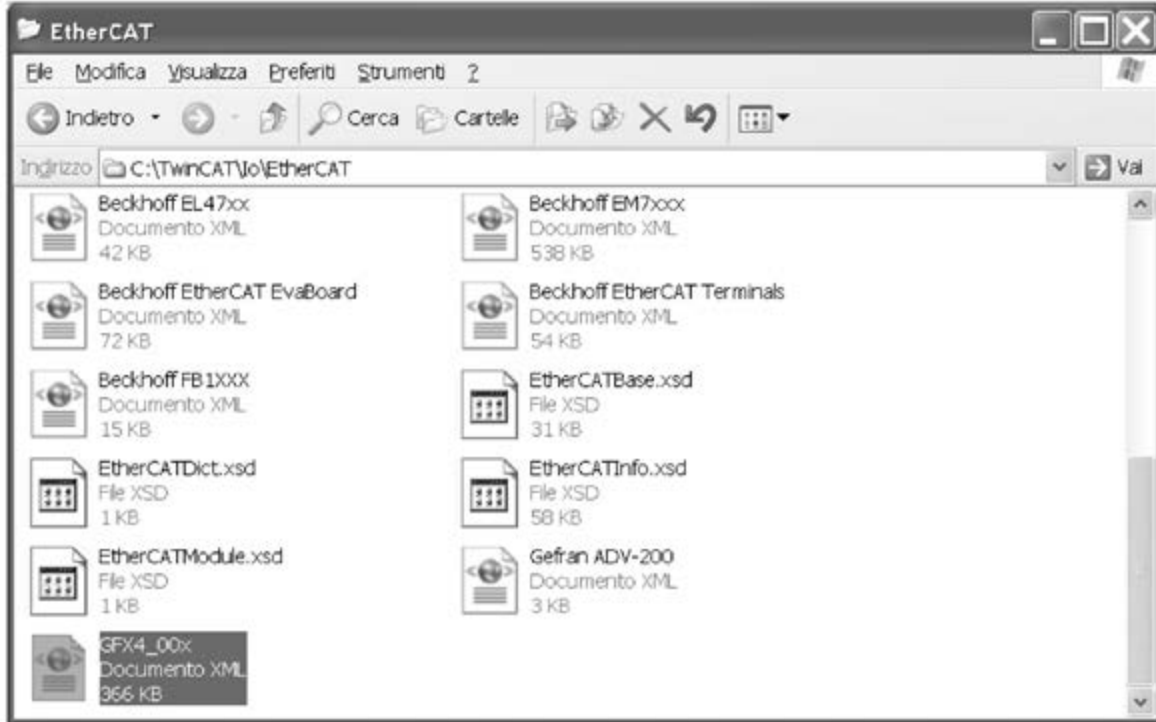

- Reboot the PC to ensure updating of the TwinCAT XML catalog
- Launch the TwinCAT system in configuration mode.

The program should appear as shown in the figure

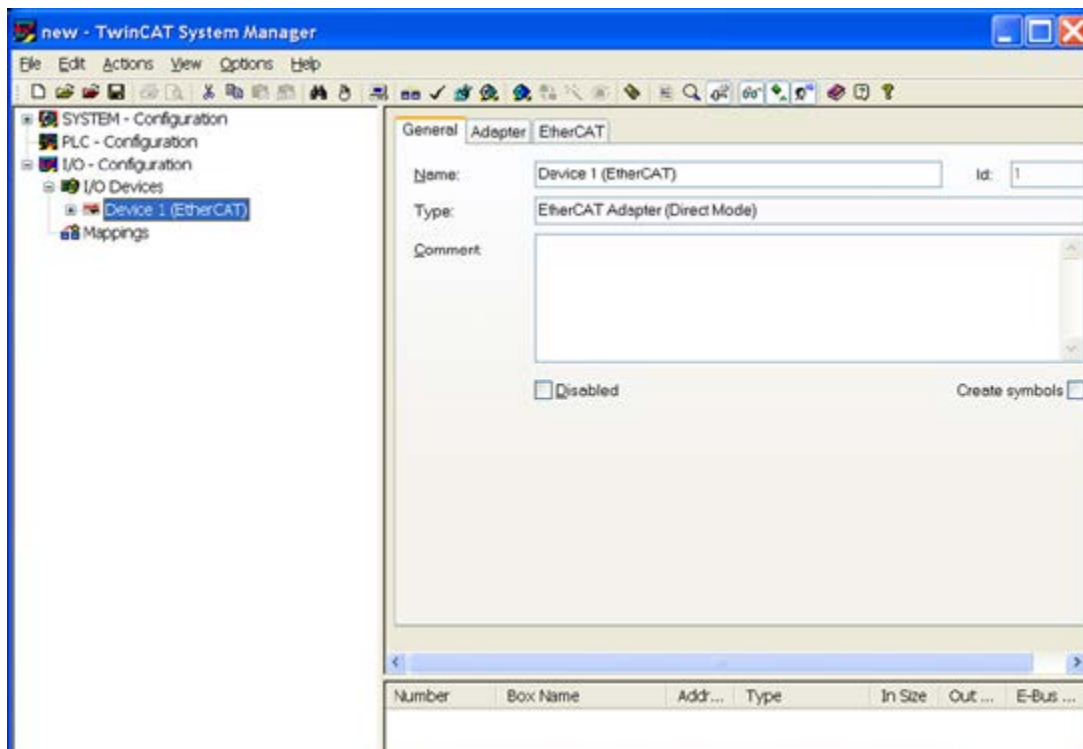

We now add a box from the I/O devices menu

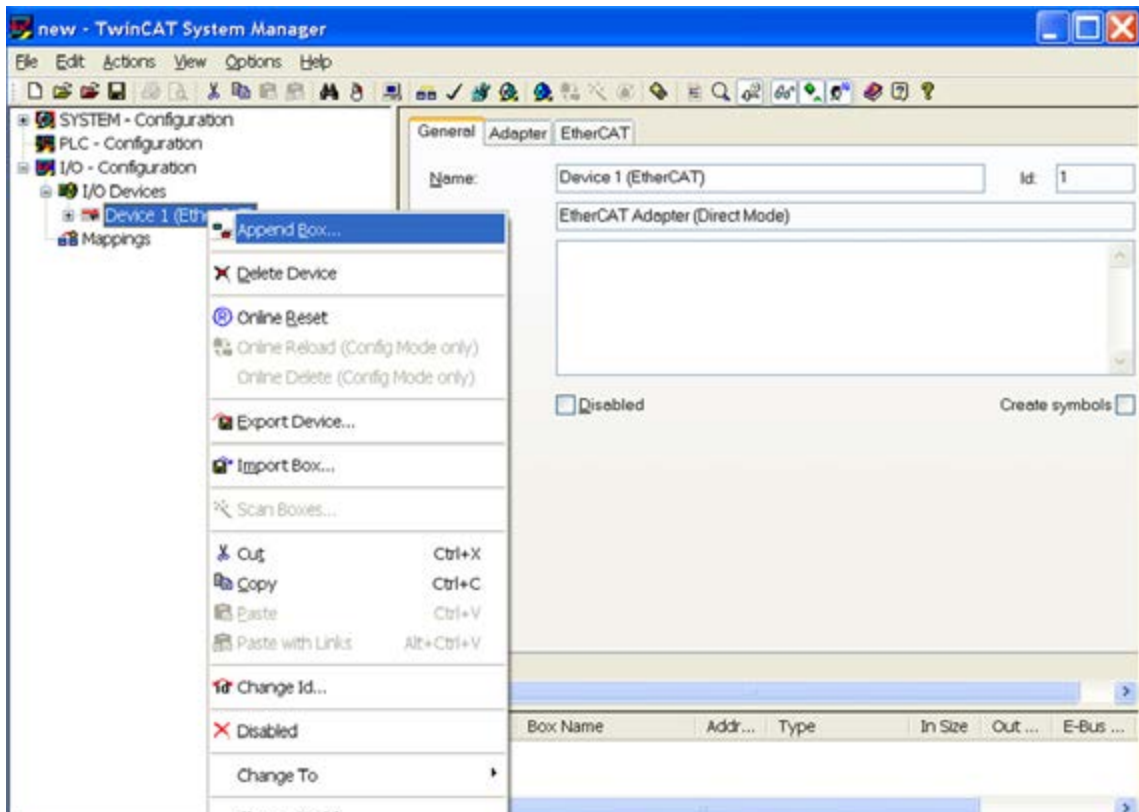

Select GFX4 20 zones



We have the following structure

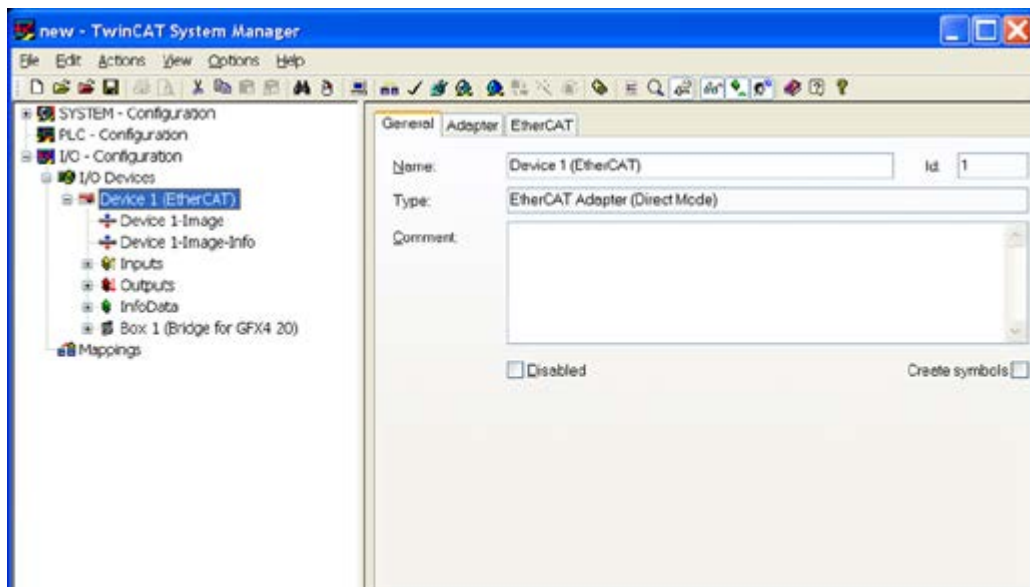

At the end of the procedure, we can activate the system in Run-Mode

GEFRAN

GEFRAN spa

Via Sebina, 74 - 25050 PROVAGLIO D'ISEO (BS) - ITALIA
tel. 0309888.1 - fax. 0309839063 Internet: <http://www.gefran.com>