



INSTALLATION and OPERATION MANUAL

SOFTWARE VERSION **3.2x** (includes R77 version)
code **81600G** / edition **13 - 07/2011**



1 • INSTALLATION

• Dimensions and cut-out; panel mounting

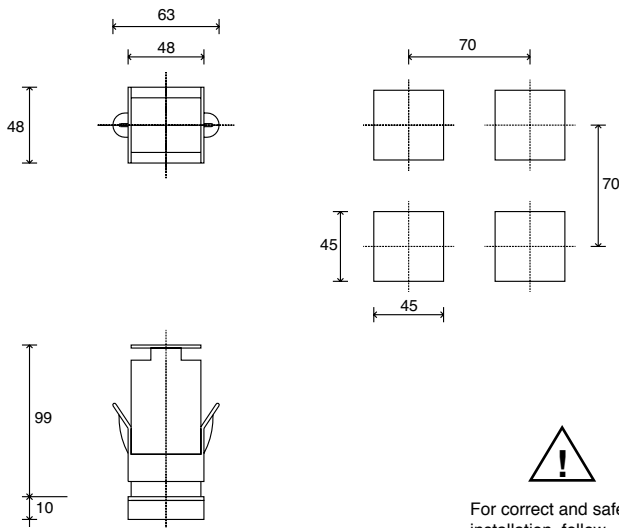

For correct and safe installation, follow the instructions and observe the warnings contained in this manual.

Panel mounting:

Fix the device with the bracket provided before making any electrical connections.
To mount two or more devices side by side, use the cut-out dimensions shown above.

CE MARKING: The instrument conforms to the European Directives 2004/108/CE and 2006/95/CE with reference to the generic standards: **EN 61000-6-2** (immunity in industrial environment) **EN 61000-6-3** (emission in residential environment) **EN 61010-1** (safety).

MAINTENANCE: Repairs must be done out only by trained and specialized personnel. Cut power to the device before accessing internal parts. Do not clean the case with hydrocarbon-based solvents (Petrol, Trichlorethylene, etc.). Use of these solvents can reduce the mechanical reliability of the device. Use a cloth dampened in ethyl alcohol or water to clean the external plastic case.

SERVICE: GEF 4T 48 has a service department. The warranty excludes defects caused by any use not conforming to these instructions.

2 • TECHNICAL SPECIFICATIONS

<i>Display</i>	4 digit red LED's; digit height 10mm,
<i>Keys</i>	3 mechanical keys (Raise, Lower, F)
<i>Accuracy</i>	0.2% f.s. at 25°C ambient temperature, ts=120msec
<i>Resolution (function of settable sample time)</i>	120msec, >14bit - 16000 points 60msec, >14bit - 16000 points (only for linear inputs) 30msec, >13bit - 8000 points (only for linear inputs) 15msec, >12bit - 4000 points (only for linear inputs)
<i>Main input</i>	TC, RTD, PTC, NTC 60mV, 1V Ri ≥ 500KΩ; 5V, 10V Ri ≥ 10KΩ 20mA, Ri = 50Ω adjustable digital filter
<i>Thermocouples</i>	J, K, R, S, T, B, E, N (IEC 584-1, CEI EN 60584-1, 60584-2) L GOST, U, G, D, C Custom linearization available on request
<i>Cold junction error</i>	0,1° / °C
<i>RTD type (scale configurable within indicated range, with or without decimal point)</i>	DIN 43760 (PT100), JPT100
<i>Max. RTD line resistance</i>	20Ω
<i>PTC type / NTC type</i>	990Ω, 25°C / 1KΩ, 25°C
<i>Max. non-linearity error</i>	See t.P parameter
<i>°C / °F selection</i>	Faceplate configurable
<i>Linear scale ranges</i>	-1999...9999 Configurable decimal point position, possible 32 segment linearization
<i>Logic input (only R77 version)</i>	24V, 5mA (Ri = 47KΩ) isolation 1500V or voltage-free contact
<i>Transmitter / Sensor Power Supply (option)</i>	24V ±10%, 50mA 15V for transmitter, max. 50mA 1,2V for potentiometer > 100Ω
<i>Power supply (switching)</i>	(std) 100...240Vac/dc ±10%, 50/60Hz, 5,5VA (opt) 20...27Vac/dc ±10%, 50/60Hz, 5,5VA
<i>Fuse (inside device, not operator serviceable)</i>	100...240Vac - tipo T - 500mA - 250V 11...27Vac/dc - tipo T - 1,25A - 250V
<i>Faceplate protection</i>	IP65
<i>Working / Storage temperatures</i>	0...50°C / -20...70°C
<i>Relative humidity</i>	20 to 85%, non-condensing
<i>Environmental conditions of use</i>	for internal use only, altitude up to 2000m
<i>Installation</i>	Panel mounting, extractable from front
<i>Weight</i>	150g

EMC conformity has been tested with the following connections

FUNCTION	CABLE	LENGTH USED
TC input probe	0.8 mm ² compensated	5 m
"PT100" input probe	1 mm ²	3 m
Power supply cable	1 mm ²	1 m

3 · DESCRIPTION OF FRONT PANEL

"Raise" and "Lower" keys:

These keys are used for any operation that requires a numerical parameter to be raised or lowered. •• The speed of change is proportional to the time the key is pressed. •• The operation is not cyclic: once the maximum (minimum) limit is reached, there will be no further increase (decrease) of the value, even if the key remains pressed.

The keys can be configured to perform reset, hold, display of the peak value, etc. as determined by the 't.U.' and 't.d.' parameters on the 'In' menu.



PV display: Indication of process variable

- Indication of 'Hi' or 'Lo' out of range
- Indication of open circuit (br) or short circuit (Er)
- Display of configuration and calibration messages

Label with engineering units

Function key:

- Gives access to different configuration stages ••
- Confirms any parameter changes

4 · CONNECTIONS

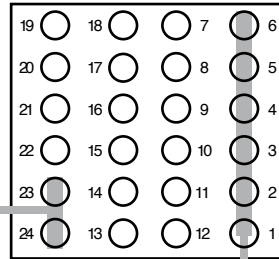

• Power supply

		Standard: 100 to 240Vac/dc ±10%
		Optional: 11 to 27Vac/dc ±10% 50/60Hz, 3,5VA max.

• Inputs

• Thermocouples

Available thermocouples:
J, K, R, S, T, B, E, N,
L, U, G, D, C

- Respect polarities
- For extensions, use compensated cable appropriate for thermocouple.

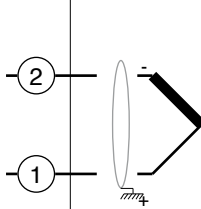

• Linear input with 2-wire transmitter

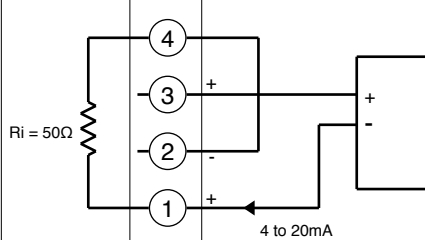

• Linear input with 3-wire transmitter

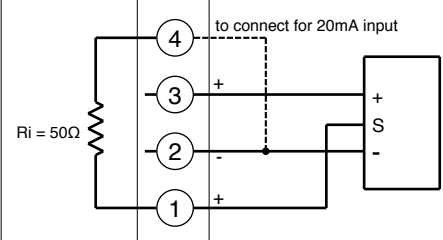

• Linear input 1V for potentiometer

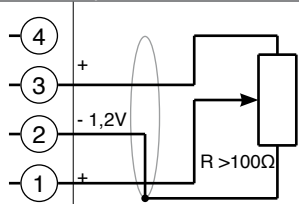

• Linear (I) - (V)

dc current linear input
20mA, Ri = 50Ω

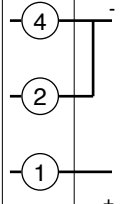

dc voltage linear input
60mV, 1V, 5V, 10V

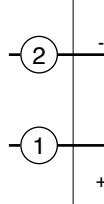

• Pt100 / PTC / NTC

Use wires of adequate thickness (min. 1mm²)
PT100,
JPT100,
PTC, NTC

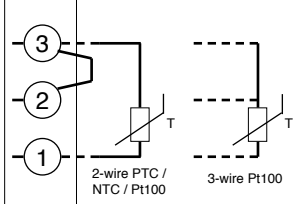

• Digital input

Digital input
24V, 5mA
or no-voltage contact
(only for R77 version)

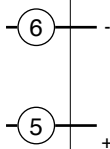

Connections for keylock function through digital input (require selection +VT for the signal on contact 3)

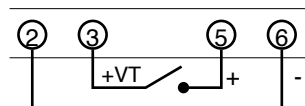

OFF (open): keyboard enable
ON (closed): keyboard disable

Device structure: identification of boards

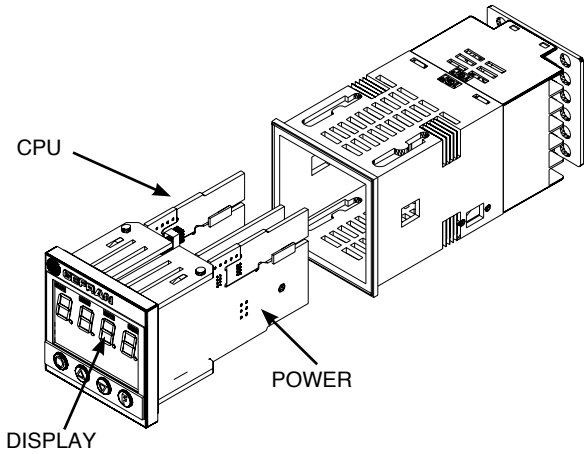

Power board - Seal side

Select transmitter voltage

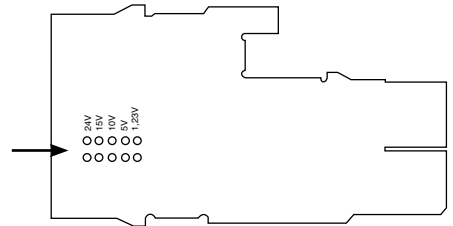

CPU board - Component side

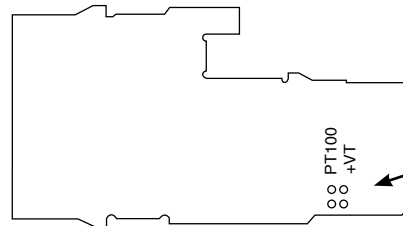

Select signal at contact 3

5 · PROGRAMMING and CONFIGURATION

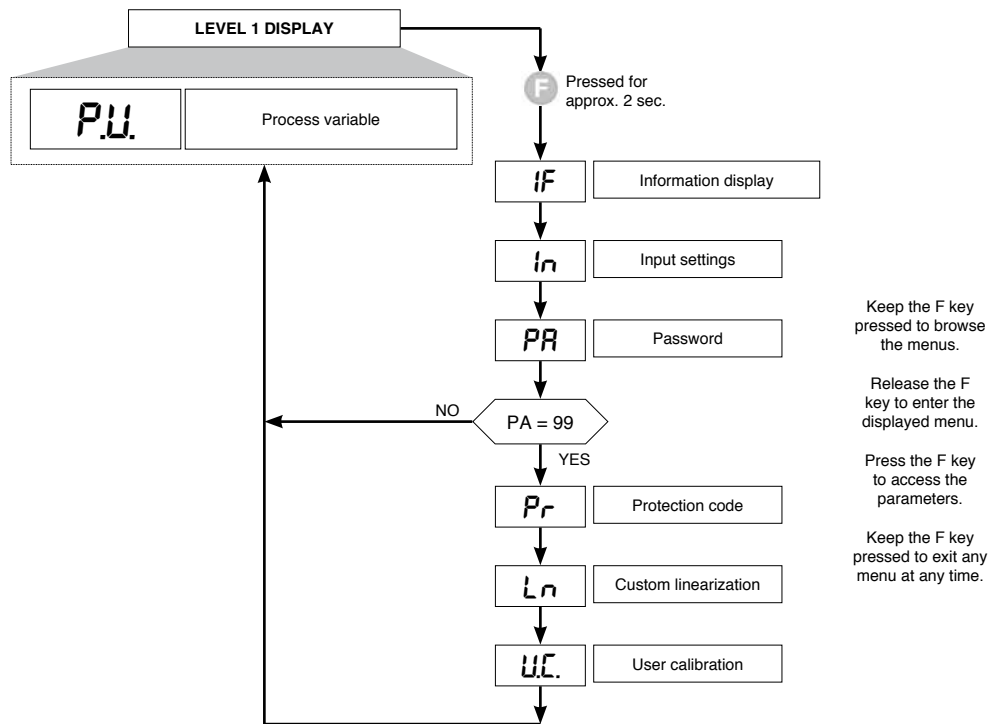

• Information display

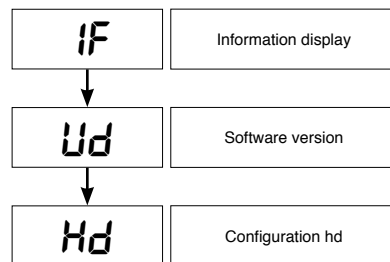

INPUT	
0	None
6	On Digital (only for R77)

• TC/LIN input parameters

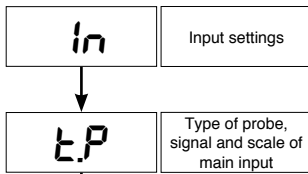

TYPE	Type PROBE	4 DIGIT	
		without dec. point	with dec. point
Probe: TC			
0	TC J °C	0/1000	0.0/999.9
1	TC J °F	32/1832	32.0/999.9
2	TC K °C	0/1300	0.0/999.9
3	TC K °F	32/2372	32.0/999.9
4	TC R °C	0/1750	0.0/999.9
5	TC R °F	32/3182	32.0/999.9
6	TC S °C	0/1750	0.0/999.9
7	TC S °F	32/3182	32.0/999.9
8	TC T °C	-200/400	-199.9/400.0
9	TC T °F	-328/752	-199.9/752.0
10	TC B °C	44/1800	44.0/999.9
11	TC B °F	111/3272	111.0/999.9
12	TC E °C	-100/750	-100.0/750.0
13	TC E °F	-148/1382	-148.0/999.9
14	TC N °C	0/1300	0.0/999.9
15	TC N °F	32/2372	32.0/999.9
16	TC L °C	0/600	0.0/600.0
17	TC L °F	32/1112	32.0/999.9
18	TC U °C	-200/400	-199.9/400.0
19	TC U °F	-328/752	-199.9/752.0
20	TC G °C	0/2300	0.0/999.9
21	TC G °F	32/4172	32.0/999.9
22	TC D °C	0/2300	0.0/999.9
23	TC D °F	32/4172	32.0/999.9
24	TC C °C	0/2300	0.0/999.9
25	TC C °F	32/4172	32.0/999.9
26	TC °C	Custom	Custom
27	TC °F	Custom	Custom
Probe: RTD			
28	PT100 °C	-200/600	-199.9/600.0
29	PT100 °F	-328/1112	-199.9/999.9
30	JPT100 °C	-200/600	-199.9/600.0
31	JPT100 °F	-328/1112	-199.9/999.9
Probe: PTC - NTC			
32	PTC °C	-55/120	-55.0/120.0
33	PTC °F	-67/248	-67.0/248.0
34	NTC °C	-10/70	-10.0/70.0
35	NTC °F	14/158	14.0/158.0
Probe: Voltage + Current			
36	0...60mV	-1999/9999	-199.9/999.9
37	0...60mV	custom linear	custom linear
38	12...60mV	-1999/9999	-199.9/999.9
39	12...60mV	custom linear	custom linear
40	0...20mA	-1999/9999	-199.9/999.9
41	0...20mA	custom linear	custom linear
42	4...20mA	-1999/9999	-199.9/999.9
43	4...20mA	custom linear	custom linear
44	0...10V	-1999/9999	-199.9/999.9
45	0...10V	custom linear	custom linear
46	2...10V	-1999/9999	-199.9/999.9
47	2...10V	custom linear	custom linear
48	0...5V	-1999/9999	-199.9/999.9
49	0...5V	custom linear	custom linear
50	1...5V	-1999/9999	-199.9/999.9
51	1...5V	custom linear	custom linear
52	0...1V/Pot	-1999/9999	-199.9/999.9
53	0...1V/Pot	custom linear	custom linear
54	200mV...1V	-1999/9999	-199.9/999.9
55	200mV...1V	custom linear	custom linear
Probe: Custom PT100 - PTC - NTC			
56	PT100	custom	custom
57	JPT	custom	custom
58	PTC	custom	custom
58	NTC	custom	custom

N.B.: for the version R77 are not available the probe codes 0...39, 48...51, 54...58

In case of probe non-availability, maximum and minimum limits are set to 0.
 In case of custom linearization, test limits for setting LO and HI errors are given by the calibration values.
 If these limits are not exceeded, they are taken into consideration as limits L_S and H_S.

<p><i>Max. non-linearity error for thermocouples (TC), resistors (PT100) and thermistors (PTC, NTC).</i></p> <p><i>The error is calculated as deviation from theoretical value and is expressed as percentage of full scale (in °C).</i></p>	<p>S, R range 0...1750°C; error < 0.2% f.s. (t > 300°C) / for other range; error < 0.5% f.s.</p> <p>T error < 0.2% f.s. (t > -150°C)</p> <p>B range 44...1800°C; error < 0.5% f.s. (t > 300°C) / range 44,0...999,9; error < 1% f.s. (t > 300°C)</p> <p>U range -99,9...99,9 and -99...99°C; error < 0.5% f.s. / for other range; error < 0.2% f.s. (t > -150°C)</p> <p>G error < 0.2% f.s. (t > 300°C)</p> <p>D error < 0.2% f.s. (t > 200°C)</p> <p>C range 0...2300; error < 0.2% f.s. / for other range; error < 0.5% f.s.</p>
	<p>NTC error < 0.5% f.s.</p> <p>Tc J, K, E, N, L error < 0.2% f.s.</p> <p>PT100, JPT100 e PTC error < 0.2% f.s.</p>

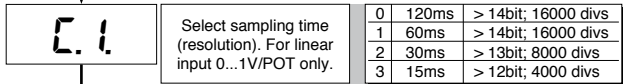

+4 to disable filter
(average of the last eight values sampled)

• Custom Linearization

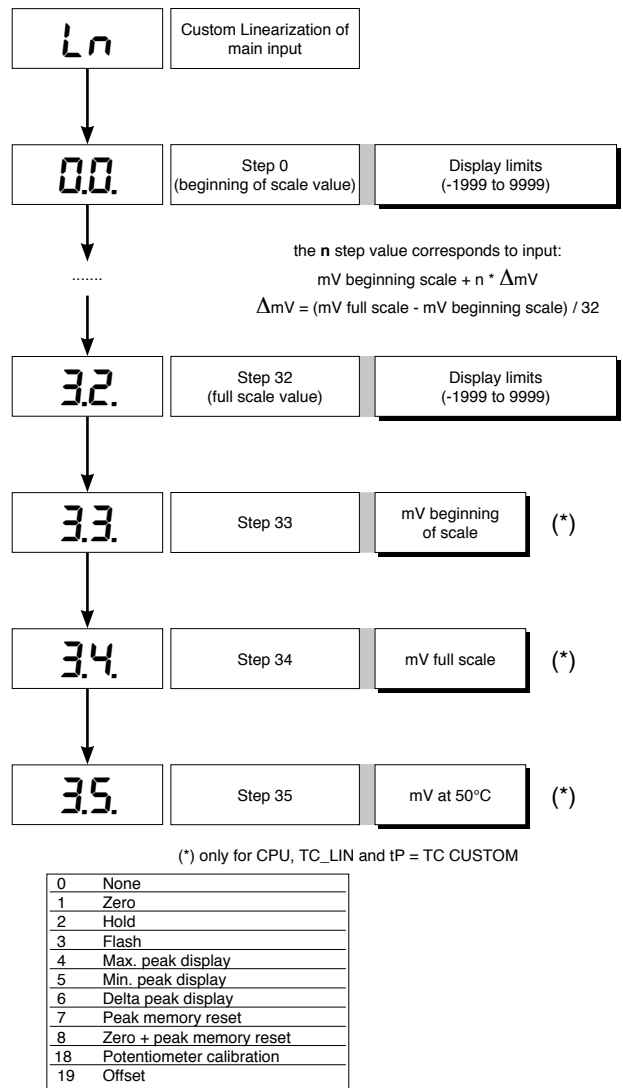

• Protection



+4 to disable In pages
 +16 to enable maintenance of reset latch at power-off (for linear inputs only)
 +32 base configuration (the following parameters will not be displayed:
 In: Ft, Fd, Of
 +128 disabled of all the menu except PA

• User Calibration

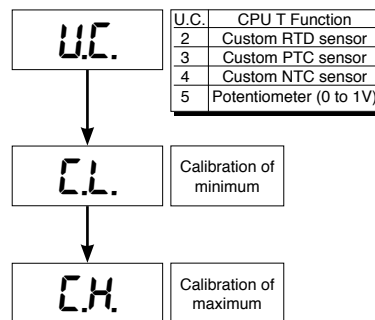

• Interface for GEFRAN instrument configuration

KIT PC USB / RS485 o TTL



Kit for PC via the USB port (Windows environment) for GEFRAN instruments configuration:

- Lets you read or write all of the parameters
- A single software for all models
- Easy and rapid configuration
- Saving and management of parameter recipes
- On-line trend and saving of historical data

Component Kit:

- Connection cable PC USB ... port TTL
- Connection cable PC USB ... RS485 port
- Serial line converter
- CD SW GF Express installation



• ORDERING CODE

GF_eXK-2-0-0 cod F049095

ORDER CODE

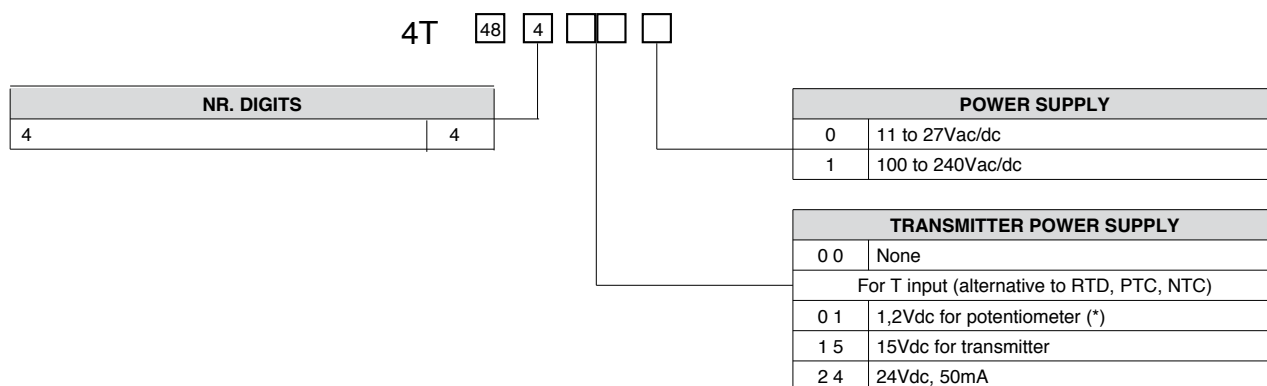

(*) R77 for version with potentiometer input ($R_{input} > 10M\Omega$)

Please, contact GEFRA sales people for the codes availability.

• WARNINGS



WARNING: this symbol indicates danger.

It is seen near the power supply circuit and near high-voltage relay contacts.

Read the following warnings before installing, connecting or using the device:

- follow instructions precisely when connecting the device.
- always use cables that are suitable for the voltage and current levels indicated in the technical specifications.
- the device has no ON/OFF switch: it switches on immediately when power is turned on. For safety reasons, devices permanently connected to the power supply require a two-phase disconnecting switch with proper marking. Such switch must be located near the device and must be easily reachable by the user. A single switch can control several units.
- if the device is connected to electrically NON-ISOLATED equipment (e.g. thermocouples), a grounding wire must be applied to assure that this connection is not made directly through the machine structure.
- if the device is used in applications where there is risk of injury to persons and/or damage to machines or materials, it MUST be used with auxiliary alarm units. You should be able to check the correct operation of such units during normal operation of the device.
- before using the device, the user must check that all device parameters are correctly set in order to avoid injury to persons and/or damage to property.
- the device must NOT be used in inflammable or explosive environments. It may be connected to units operating in such environments only by means of suitable interfaces in conformity to local safety regulations.
- the device contains components that are sensitive to static electrical discharges. Therefore, take appropriate precautions when handling electronic circuit boards in order to prevent permanent damage to these components.

Installation: installation category II, pollution level 2, double isolation

The equipment is intended for permanent indoor installations within their own enclosure or panel mounted enclosing the rear housing and exposed terminals on the back.

• power supply lines must be separated from device input and output lines; always check that the supply voltage matches the voltage indicated on the device label.

- install the instrumentation separately from the relays and power switching devices
- do not install high-power remote switches, contactors, relays, thyristor power units (particularly if "phase angle" type), motors, etc... in the same cabinet.
- avoid dust, humidity, corrosive gases and heat sources.
- do not close the ventilation holes; working temperature must be in the range of 0...50°C.

If the device has faston terminals, they must be protected and isolated; if the device has screw terminals, wires should be attached at least in pairs.

• **Power:** supplied from a disconnecting switch with fuse for the device section; path of wires from switch to devices should be as straight as possible; the same supply should not be used to power relays, contactors, solenoid valves, etc.; if the voltage waveform is strongly distorted by thyristor switching units or by electric motors, it is recommended that an isolation transformer be used only for the devices, connecting the screen to ground; it is important for the electrical system to have a good ground connection; voltage between neutral and ground must not exceed 1V and resistance must be less than 60Ωm; if the supply voltage is highly variable, use a voltage stabilizer for the device; use line filters in the vicinity of high frequency generators or arc welders; power supply lines must be separated from device input and output lines; always check that the supply voltage matches the voltage indicated on the device label.

• **Input and output connections:** external connected circuits must have double insulation; to connect analog inputs (TC, RTD) you have to: physically separate input wiring from power supply wiring, from output wiring, and from power connections; use twisted and screened cables, with screen connected to ground at only one point; to connect adjustment and alarm outputs (contactors, solenoid valves, motors, fans, etc.), install RC groups (resistor and capacitor in series) in parallel with inductive loads that work in AC (*Note: all capacitors must conform to VDE standards (class x2) and support at least 220 VAC. Resistors must be at least 2W*); fit a 1N4007 diode in parallel with the coil of inductive loads that operate in DC.

GEFRAN spa will not be held liable for any injury to persons and/or damage to property deriving from tampering, from any incorrect or erroneous use, or from any use not conforming to the device specifications.