

INSTALLATION AND OPERATION MANUAL

SOFTWARE VERSION 3.2x
code 80215G / Ed. 07-2021



1 • INSTALLATION

• Dimensions and cut-out; panel mounting

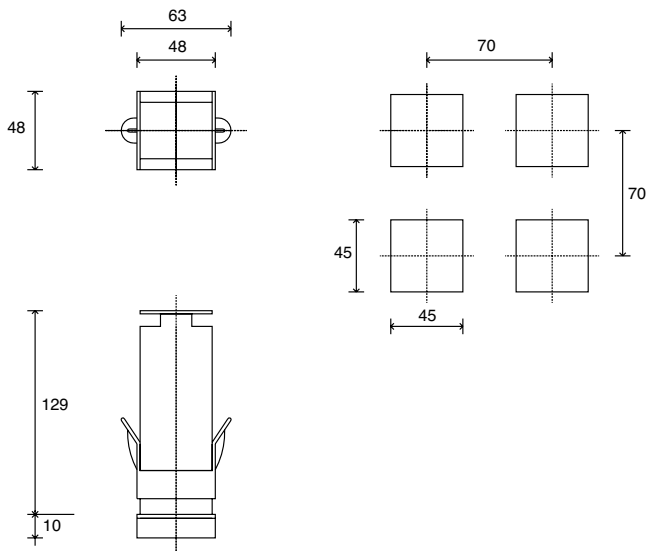

!
For correct and safe installation, follow the instructions and observe the warnings contained in this manual.

Panel mounting:

To fix the unit, insert the brackets provided into the seats on either side of the case. To mount two or more units side by side, respect the cut-out dimensions shown in the drawing.

CE MARKING: The instrument conforms to the European Directives 2004/108/CE and 2006/95/CE with reference to the generic standards: **EN 61000-6-2** (immunity in industrial environment) **EN 61000-6-3** (emission in residential environment) **EN 61010-1** (safety).

MAINTENANCE: Repairs must be done only by trained and specialized personnel.

Cut power to the device before accessing internal parts.

Do not clean the case with hydrocarbon-based solvents (Petrol, Trichlorethylene, etc.).

Use of these solvents can reduce the mechanical reliability of the device. Use a cloth dampened in ethyl alcohol or water to clean the external plastic case.

SERVICE: GEF 800P has a service department. The warranty excludes defects caused by any use not conforming to these instructions.

2 • TECHNICAL SPECIFICATIONS

| | |
|---|--|
| Display | 2 x 4 digits, green, height 10 and 7mm |
| Keys | 4 mechanical keys (Man/Auto, INC, DEC, F) |
| Accuracy | 0.2% full scale at 25°C room temperature |
| Main input | TC, RTD (Pt100 - JPT100), PTC, 50mV Ri ≥ 1MΩ; 10V Ri ≥ 10KΩ; 20mA, Ri = 50Ω |
| Thermocouples | IEC 584-1 (J, K, R, S, T, B, E, N, Ni-Ni18Mo, L NiCr-CuNi) |
| Cold junction error | 0,1° / °C |
| RTD type (scale configurable within indicated range, with or without decimal point) | DIN 43760 (Pt100, JPT100) |
| PTC type (on request) | 990Ω, 25°C |
| Max line resistance for RTD | 20Ω |
| Safety | detection of short-circuit or opening of probes, LBA alarm, HB alarm |
| °C / °F selection | configurable from faceplate |
| Linear scale ranges | -1999 to 9999 with configurable decimal point position |
| Controls | PID, Self-tuning, on-off |
| pb / dt / di | 0.0 ... 999.9% / 0.00 ... 99.99min / 0.00 ... 99.99min |
| Action | Heat / Cool |
| Control outputs | on / off, pwm |
| Cycle time | 0.1 ... 200 sec |
| Main output type | Relay, Logic, Continuous (optional) |
| Softstart | 0.0 ... 500.0 min |
| Maximum power limit heat / cool | 0.0 ... 100.0 % |
| Fault power setting | -100.0 ... 100.0 % |
| Automatic blanking | Optional exclusion, displays PV value |
| Configurable alarms | 3 configurable alarms type: max, min, symmetrical, absolute or relative, LBA, HB |
| Alarm masking | - exclusion during warm up - latching reset from faceplate or external contact |
| Type of relay contact | NO (NC), 5A, 250V, cosφ = 1 |
| Logic output for static relays | 11Vdc, R _{out} = 220Ω (6V/20mA) |
| Remote setpoint or ammeter input (options) | 0 ... 10V, 2 ... 10V, Ri ≥ 1MΩ 0 ... 20mA, 4 ... 20mA, Ri = 5Ω Potentiometer > 500Ω, CT 50mAac, 50/60Hz, Ri = 1,5Ω, isolation 1500V |
| CT scale range | configurable from 0, ... , 100.0A |
| Transmitter power supply (optional) | filtered 10 / 24Vdc, max 30mA short-circuit protection, isolation 1500V |
| Analogue retransmission signal (opt) | 10V / 20mA, isolation 1500V |
| Logic inputs (optional) | 24V NPN, 4.5mA; 24V PNP, 3.6mA isolation 1500V |
| Serial interface (optional) | CL; RS422/485; RS232; isolation 1500V |
| Baud rate | 1200 ... 19200 |
| Protocol | GEFRAN / MODBUS |
| Power supply (switching type) | (std) 100 ... 240Vac/dc ±10%; 50/60Hz, 12VA max (opz.) 20...27Vac/dc ±10%; 50/60Hz, 12VA max |
| Faceplate protection | IP65 |
| Working / Storage temperature range | 0...50°C / -20...70°C |
| Relative humidity | 20 ... 85% Ur non-condensing |
| Environmental conditions of use | for internal use only, altitude up to 2000m |
| Installation | Panel, plug-in from front |
| Weight | 210g (complete version) |

EMC conformity has been tested with the following connections

| FUNCTION | CABLE TYPE | LENGTH |
|-----------------------------|---------------------------------|--------|
| Power supply cable | 1 mm ² | 1 m |
| Relay output cable | 1 mm ² | 3,5 m |
| Digital communication wires | 0,35 mm ² | 3,5 m |
| C.T. connection cable | 1,5 mm ² | 3,5 m |
| TC input | 0,8 mm ² compensated | 5 m |
| Pt100 input | 1 mm ² | 3 m |

3 · DESCRIPTION OF FACEPLATE

Function indicator:
Indicates modes of operation
MAN = OFF (Automatic control)
MAN = ON (Manual control)
AUX = ON (program in reset)
PRG = ON (program running)

Indication of output states
OUT 1 (Main); OUT 2 (AL 1);
OUT 3 (AL 2); OUT 4 (HB)

PV Display: Indication of process variable
Error Indication: LO, HI, Sbr, Err
LO = the value of process variable is < di LO_S
HI = the value of process variable is > di HI_S
Sbr = faulty sensor or input values higher than max. limits
Err = PT100 third wire opened for PT100, PTC or input values lower than min. limits (i.e.: TC wrong connection)

SV display: Indication of setpoint

Function key:
Gives access to the various configuration phases • Confirms change of set parameters and browses next or previous parameter (if Auto/Man key is pressed)

Auto / Manual selection
Only active in level 1 menu

"Raise" and "Lower" key

Press to increment (decrement) any numerical parameter • Increment (decrement) speed is proportional to time key stays pressed • The operation is not cyclic: once the maximum (minimum) value of a field is reached, the value will not change even if the key remains pressed.

4 · CONNECTIONS

Serial line

Configurable serial line isolated to 1500V
Passive current loop (max. 1200 baud)

RS422/485 or RS232 (optional)

Outputs

| | | | |
|--------------------|---|---|---|
| Out4 (AL3/HB) (W1) | 7 | User configurable generic output | 8 |
| - | 7 | - 5A/250Vac relay, $\cos\varphi=1$ - 11Vdc logic, Rout = 220Ω (6V/20mA) | |
| + | 8 | - analogue output isolated to 1500V (0...10V, 0...20/4...20mA) | |

Inputs

| | | | |
|-----------------------------|---|----------------------|---|
| Pt100 2-wires or PTC | | Pt100 3-wires | |
| 3 | 2 | 3 | 2 |
| 2 | 1 | 2 | 1 |
| 1 | | 1 | |

Use wires of adequate diameter (min. 1mm²)
PT100, JPT100, PTC

TC

Available thermocouples: J, K, R, S, T, B, E, N, Ni-Ni18Mo, L NiCr-CuNi
- Observe polarities
- For extensions, use the correct compensating cable for the type of TC used

Linear (V)

Linear input in dc voltage
0...50mV, 10...50mV, 0...10V, 2...10V
Potentiometer 0...10V

Linear (I)

Linear input in dc current
0...20mA, 4...20mA

Outputs

| | | | |
|-------------|----|--|----|
| Out2 (AL1) | 19 | User configurable generic output | 20 |
| - | 19 | - 5A/250Vac relay, $\cos\varphi = 1$ - 11Vdc logic, Rout = 220Ω (6V/20mA) | |
| + | 20 | | |
| Out1 (Main) | 21 | | 22 |
| - | 21 | | |
| + | 22 | | |

Power Supply

| | | |
|-----|----|-------------------------------|
| ~ | 23 | Standard: 100...240Vac/Vdc |
| PWR | | Optional: 20...27Vac/Vdc |
| ~ | 24 | 50/60Hz |

Auxiliary inputs

| | | |
|-----|----|--|
| - ~ | 14 | Auxiliary input isolated 1500V |
| | | Current transformer 50mAac, 1.5Ω, 50/60Hz |
| + ~ | 13 | Remote setpoint 0...20, 4...20mA, 5Ω 0...1V, 0...10V, > 1MΩ |

Transmitter supply

| | | |
|------|----|--|
| GND | 11 | Transmitter supply isolated 1500V |
| + Vt | 12 | 10/24Vdc, max. 30mA short-circuit protection |

Digital inputs / Out 5

| | | | | |
|--|---|---------|----|-----|
| Out 5 analogue (W2) (alternative to IN2 digital input) | 9 | + | 9 | IN2 |
| (*) terminal 11 if Out 4 is Relay or Logic | 7 | COM (*) | 10 | IN1 |
| | | | 11 | COM |

Digital input isolated to 1500V
- NPN 24V, 4,5mA
- PNP 24V, 3,6mA (12V, 3,6mA)
(In alternative Out 5)

5 · RECOMMENDED WIRING LAYOUT

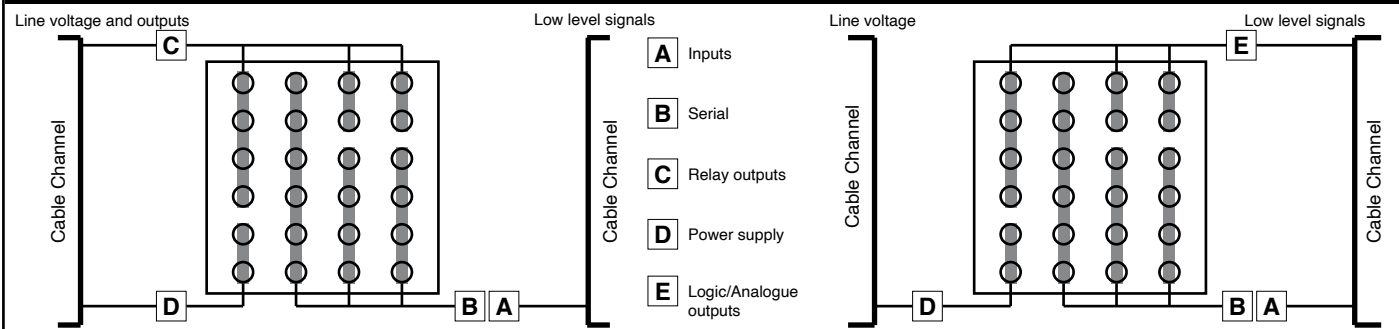

Unit layout

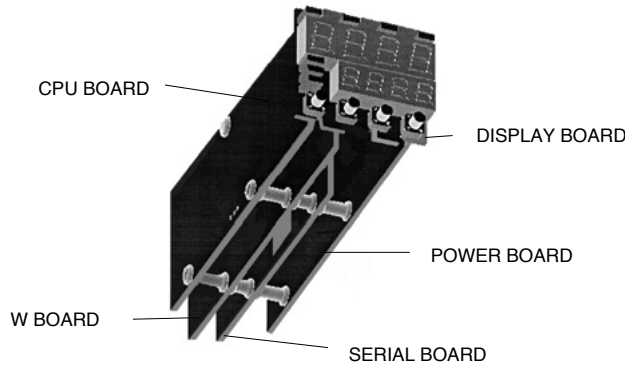

5 • PROGRAMMING and CONFIGURATION

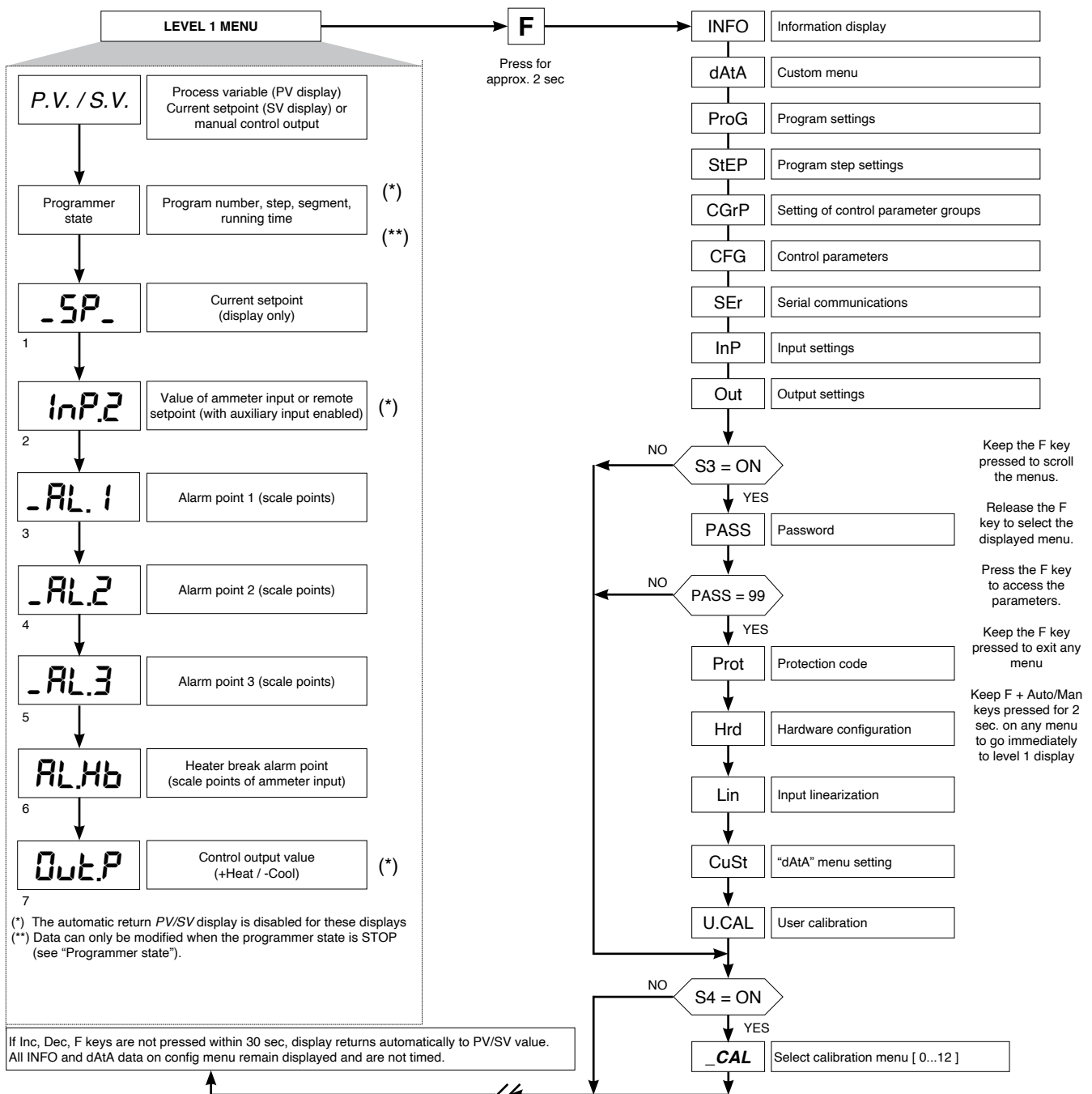

Nota: Once a particular configuration is entered, all unnecessary parameters are no longer displayed

• InFo Display

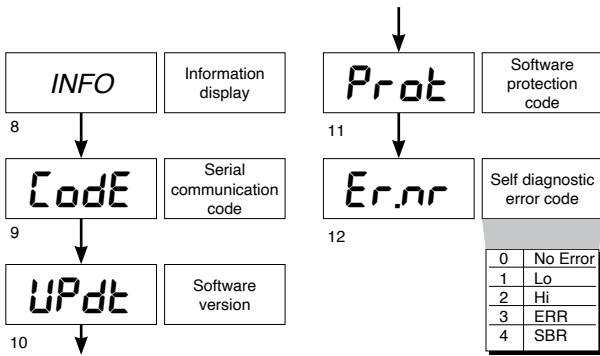

• ProG

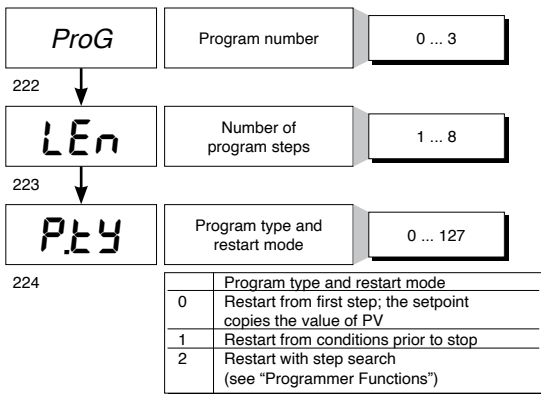

- + 8 Wait for STOP / START switching
- + 16 Continuous loop; at end of cycle the program restarts from first step (excludes +32 function)
- + 32 At end of cycle the control output goes to "FACp" value, set in "CFG" menu
- +64 Fast simulation (see "Programmer Functions")

• StEP

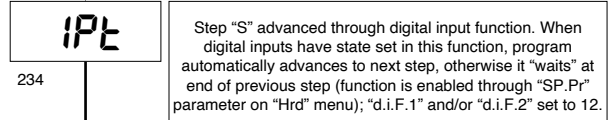
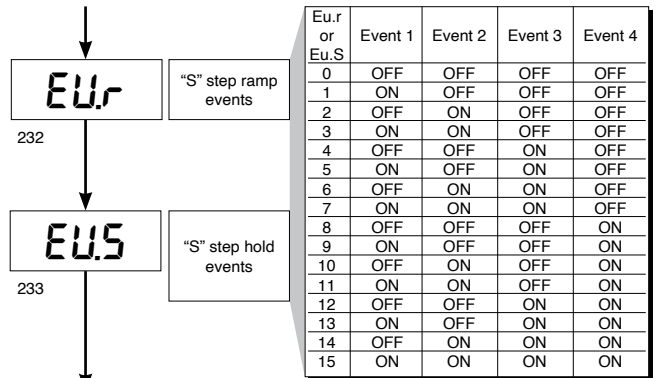
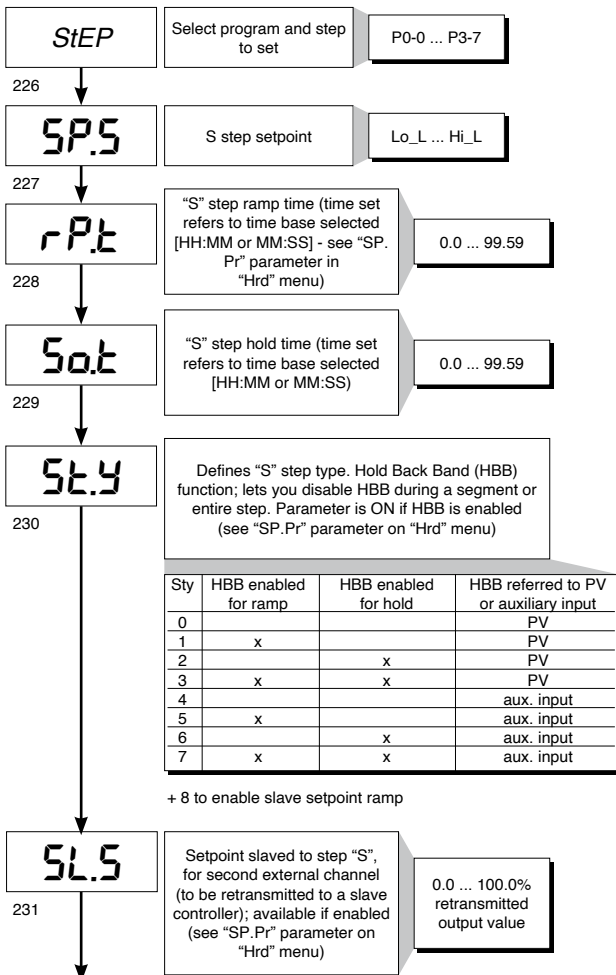

| IPt | IN1 = ON | IN2 = ON |
|-----|----------|----------|
| 0 | | |
| 1 | x | |
| 2 | | x |
| 3 | x | x |

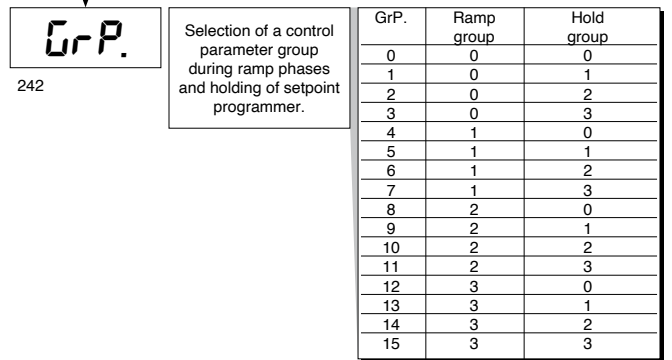
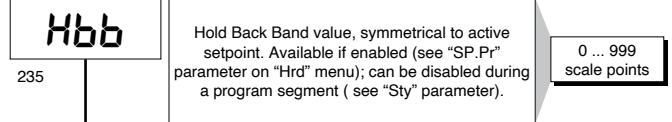

+ 16 to force the power limit of group 0 when in "hold" phase

• C.GrP

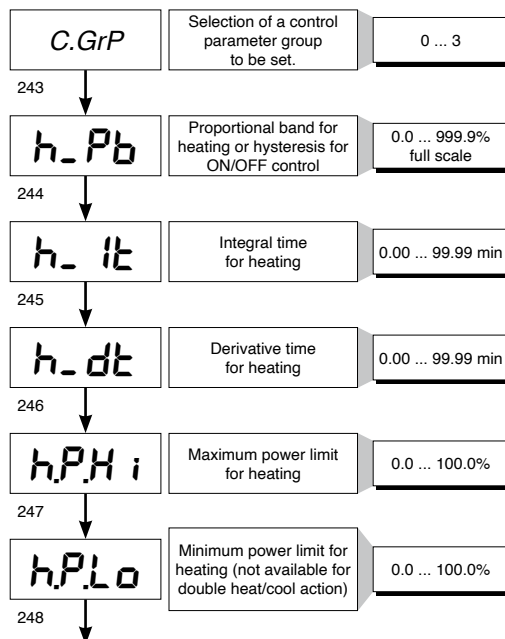

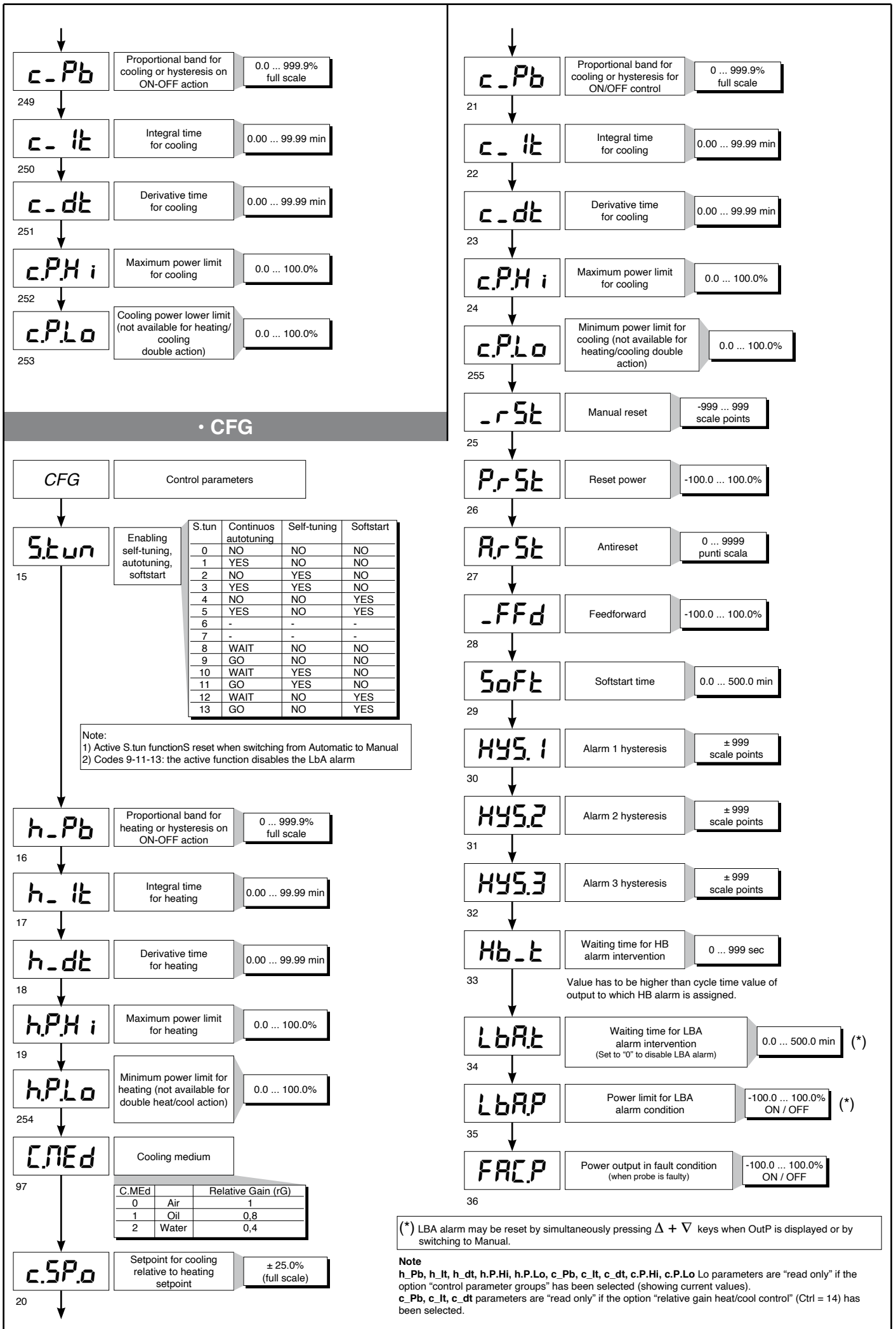

• Ser

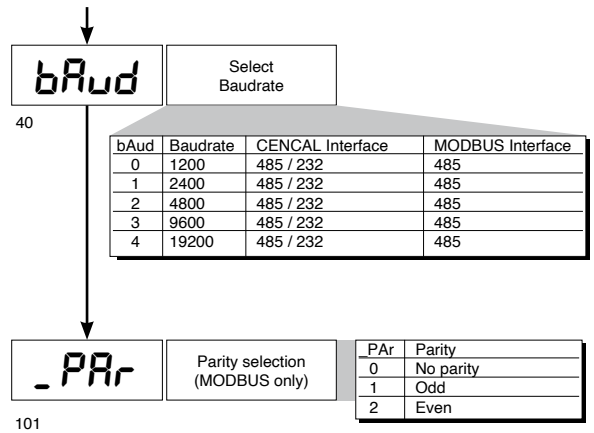
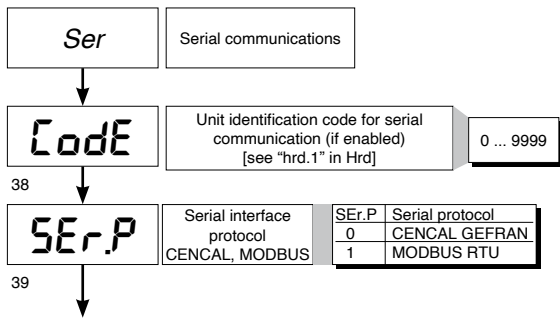

• InP

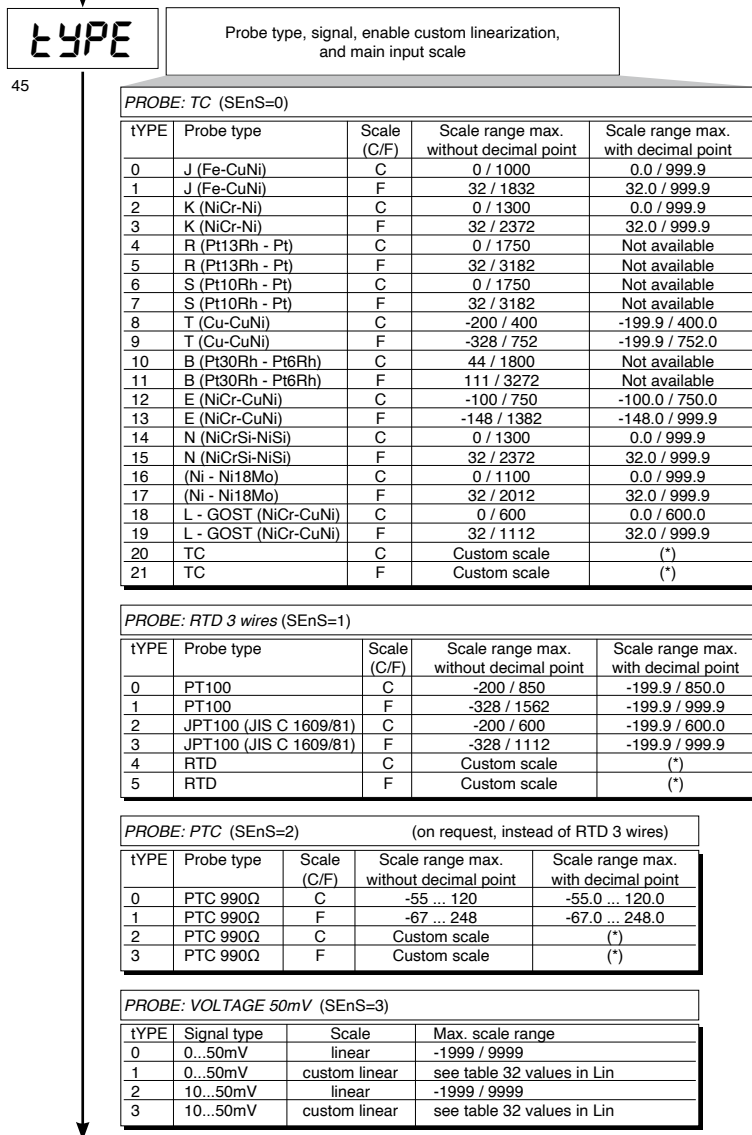
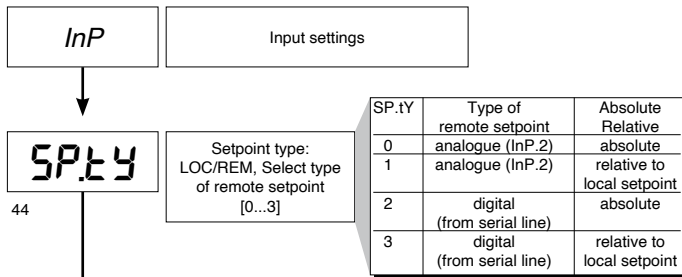

PROBE: CURRENT 20mA or TRANSMITTER (SEnS=4)

| tYPE | Signal type | Scale | Scale range max. |
|------|-------------|---------------|----------------------------|
| 0 | 0...20mA | linear | -1999 / 9999 |
| 1 | 0...20mA | custom linear | see table 32 values in Lin |
| 2 | 4...20mA | linear | -1999 / 9999 |
| 3 | 4...20mA | custom linear | see table 32 values in Lin |

PROBE: CURRENT 10V or TRANSMITTER (SEnS=5)

| tYPE | Signal type | Scale | Scale range max. |
|------|-------------|---------------|----------------------------|
| 0 | 0...10V | linear | -1999 / 9999 |
| 1 | 0...10V | custom linear | see table 32 values in Lin |
| 2 | 2...10V | linear | -1999 / 9999 |
| 3 | 2...10V | custom linear | see table 32 values in Lin |

PROBE: CUSTOM 10V (SEnS=6)

| tYPE | Signal type | Scale | Scale range max. |
|------|----------------|---------------|----------------------------|
| 0 | Custom 0...10V | linear | -1999 / 9999 |
| 1 | Custom 0...10V | custom linear | see table 32 values in Lin |

PROBE: CUSTOM 50mV, 20mA (SEnS=7)

| tYPE | Signal type | Scale | Scale range max. |
|------|-------------|---------------|----------------------------|
| 0 | Custom | linear | -1999 / 9999 |
| 1 | Custom | custom linear | see table 32 values in Lin |

(*) Linearization and scale limit settings (with or without decimal point) are selectable from PC via serial line

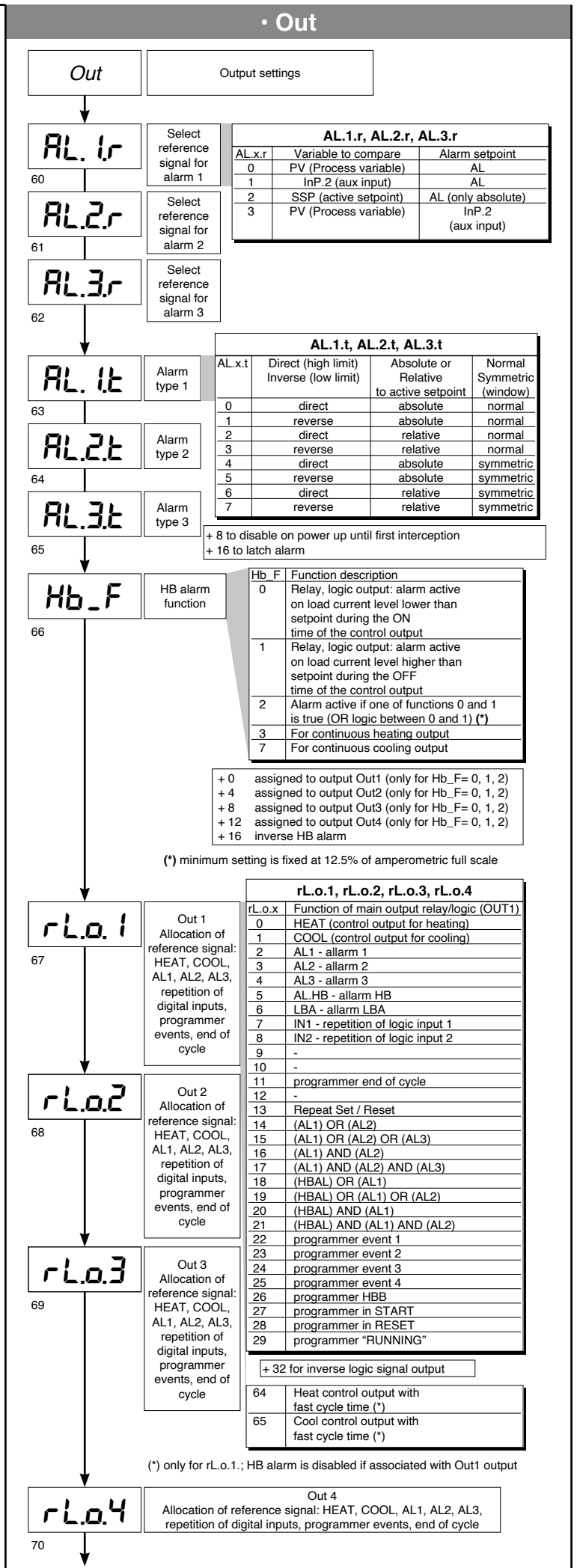
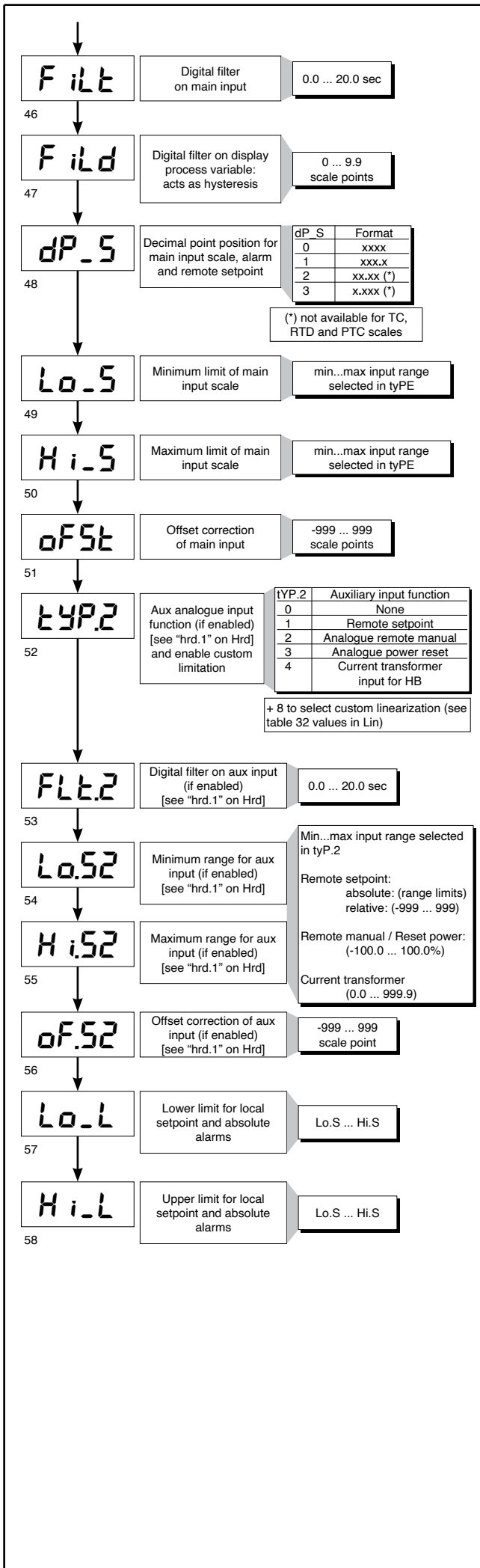

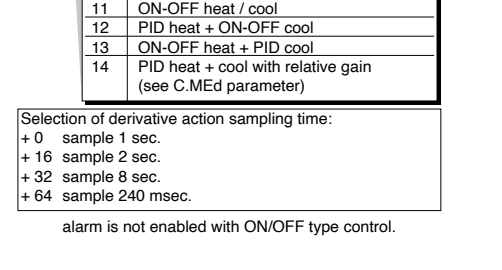
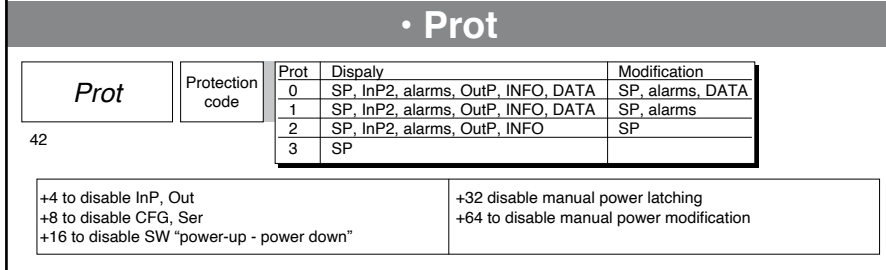
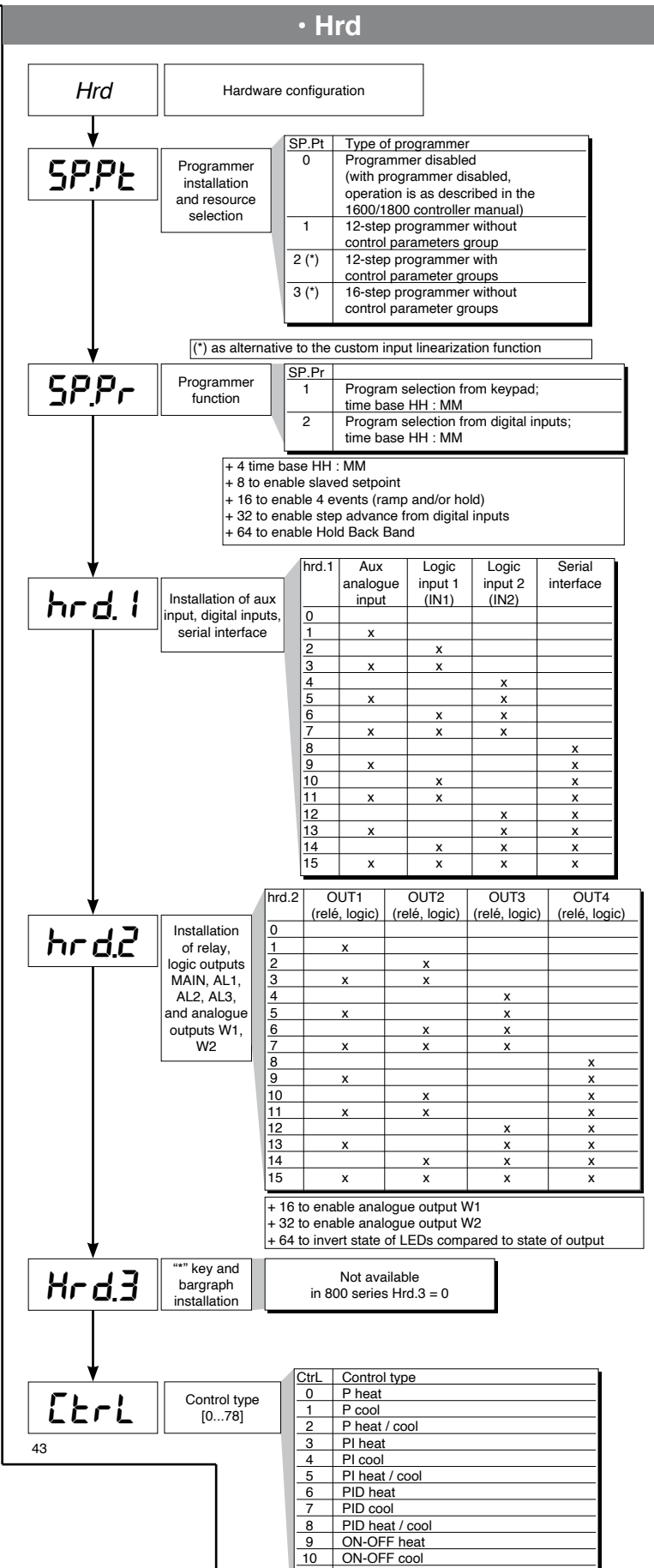
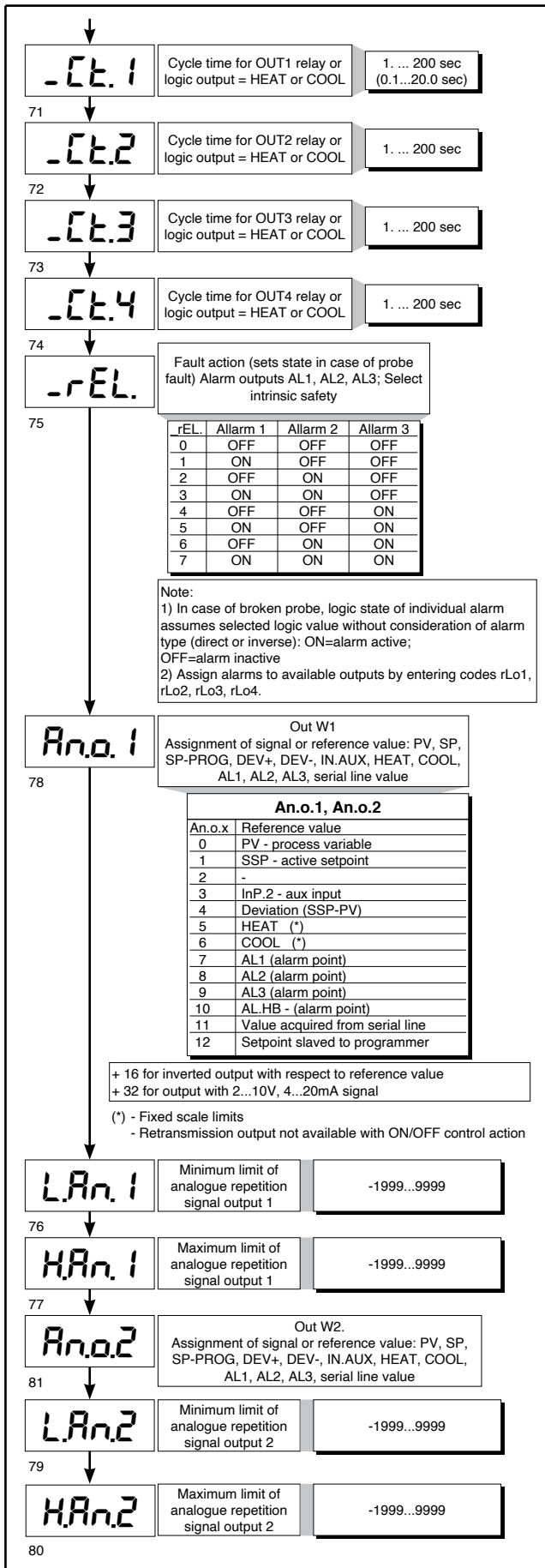

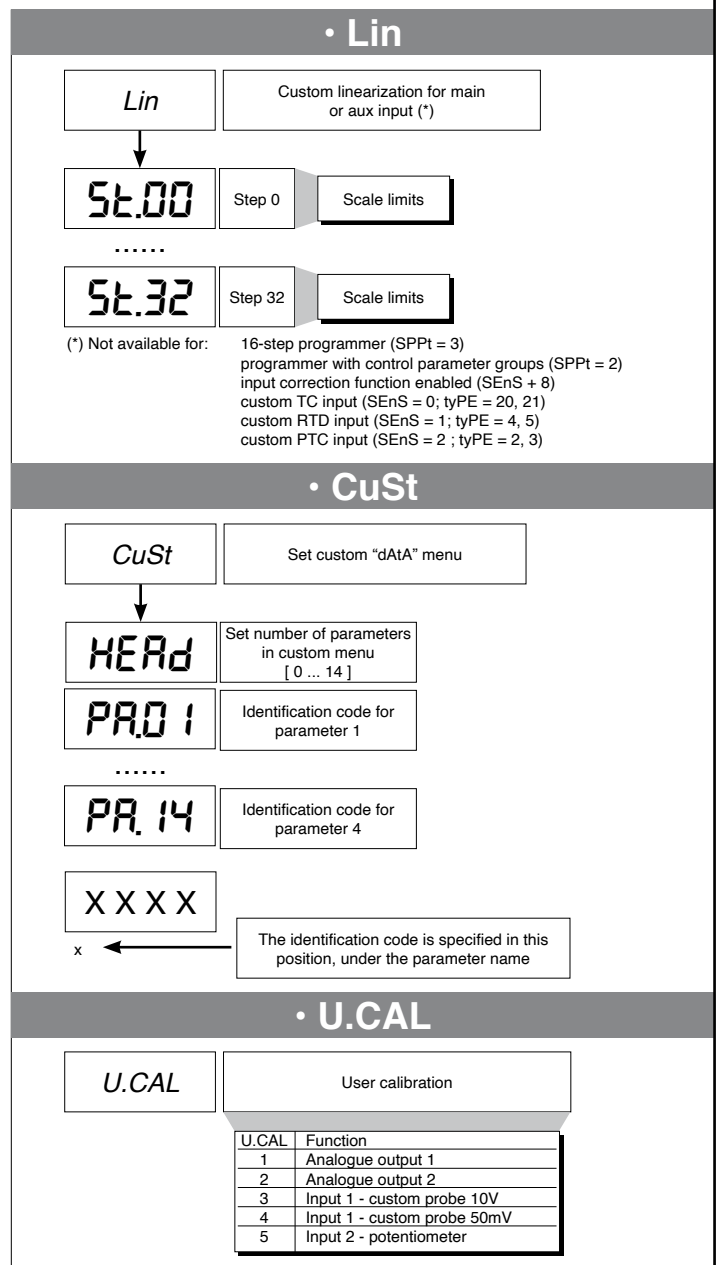
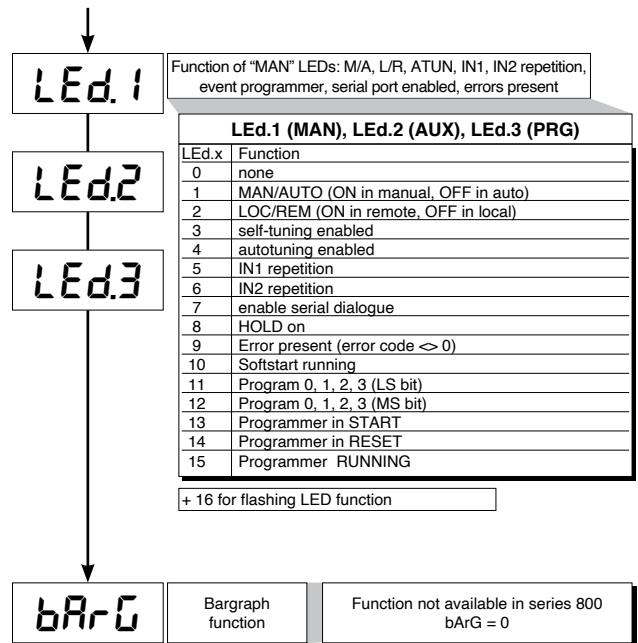
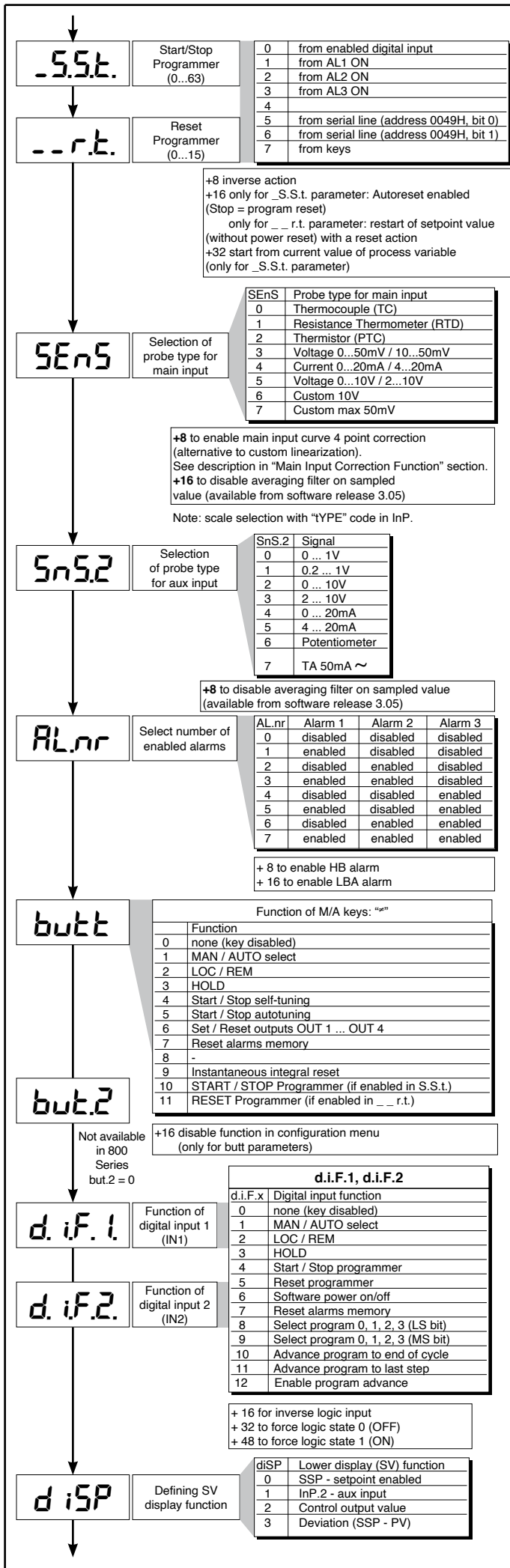

6 · PROGRAMMER

The unit combines the functions of a single loop controller and programmer.

The programmer function lets you run a program as a series of steps, each of which has two segments:

- + a ramp
- + a hold.

Every step has its associated data:

- SPs: a setpoint value
- rPt: ramp time from 0.0 to 99h59m (time base in h. m.) or 99m59s (time base in m. s.); set a time that gives a faster or slower variation depending on the initial value and on the final setpoint.
- Sot: hold time from 0.0 to 99h59m (time base in h. m.) or 99m59s (time base in m. s.).
- Hbb: tolerance band, symmetrically positioned above and below the setpoint, and referenced to the main input or the auxiliary input.
- Eur: outputs 1...4; combination codes for outputs (0-15) programmable for the ramp phase.
- EuS: outputs 1...4; combination codes for outputs (0-15) programmable for the hold phase.
- iPt: active inputs (ON) as clearance for execution.
- SLS: slave setpoint to transmit to a slave controller with the same time base.
- GrP: parameter groups to control and limit power (up to 4), selectable by single segment.

There are 12 (16*) program steps available that can make up a maximum of 4 programs.

Examples of arrangements:

2 program of 8 and 4 steps; 4 programs of 3 steps; 2 programs of 6 steps; etc...

It is important to remember that the parameter Sty defines enabling of Hbb (on the ramp, in hold, or both) and the reference value (PV or aux input).

(*) Alternative to custom linearization function (see parameter SP.Pr, Hrd menu).

Program example

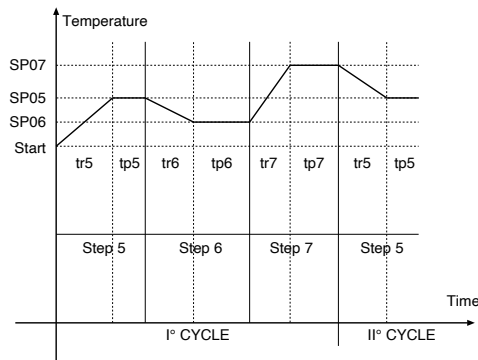

Function Hbb example (holding band)

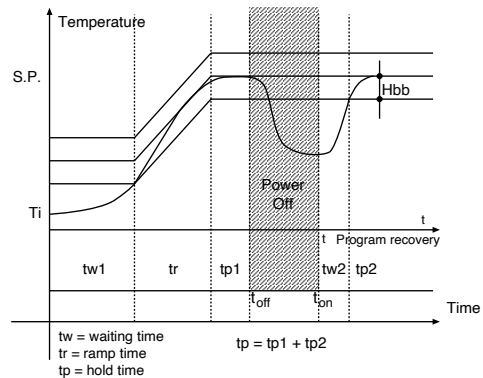

7 · USING THE PROGRAMMER

There are up to 12 (16*) steps arrangeable in 4 programs. A program step contains the ramp and the hold time.

Ramp times and hold times are programmable with a time base selected as 99h59m or 99m59s.

Time base accuracy is greater than 4 secs every 10 hours.

Program selection from faceplate, digital input or serial line.

Program control from keys, digital inputs (START/STOP, RESET, end of program), serial line or events AL1/AL2/AL3.

Program stopping and restarting modes:

- from digital input; from "Raise" (START) key, "Lower" (STOP) key or "M/A" (RESET) key in absence of other enablings
- from state of alarms (ON = START)
- different modes of restarting after a power failure
- from setpoint prior to power failure
- from value of process variable at power-up
- with search for best setpoint forward/backward in time
- awaiting a start

In the STOP phase, it is possible to change:

- current setpoint
- current step time
- program number
- step number
- phase or segment (ramp or hold)

The clearance input and event outputs assigned to an individual step. Programmed input conditions are scanned at the beginning of every step. If satisfied, execution begins with updating of assigned outputs and restart of time base.

Indication of end of program, with or without forcing of control output.

Setting a tolerance band for setpoint: if the process variable is outside the band, the time base stops (Hbb - Hold back band alarm).

Secondary setpoint with the same time base to manage a slave controller using retransmission output W1 or W2.

Full functional modularity, with easy exclusion of functions not needed.

Up to 4 parameter groups to control and limit power, selectable by single segment (ramp and/or hold) (*).

(*) Alternative to custom linearization of inputs (see parameter SP.Pr, Hrd menu).

Programmer functions

Variation of the local setpoint when the program is stopped will restart the current step, keeping the same ramp time.

If the unit is switched off and then switched on, the program can continue or can start again at the first step. Or it can search for the step that has the setpoint closest to the PV (see Pty parameter in ProG configuration to define restart conditions).

STOP/START switching at end of program resets and restarts the program.

Fast simulation of program:

A selected program can easily be checked by running it in **fast simulation** mode.

To do this, set code Pty +64 in the ProG menu.
 The program runs with the ramp and hold times limited to 20 and 10 seconds, respectively. Lower values entered are accepted.
 In this mode, the maximum duration of a step is 30 seconds
 In fast simulation mode, hold back band (Hbb) is inhibited, and control output takes on FAc.P value.
 All other functions enabled (type of restart, start/stop, reset, manual/automatic, end of cycle or continuous cycle, event outputs, clearance from digital inputs, slave channel setpoint, etc.) are active.
 - Autoreset means that programmer reset is active in Stop phase, with acquisition of the variable as current setpoint and resetting of time base.
 - With the controller in manual or with absolute remote setpoint, the programmer time base is stopped.
 - When switching from remote to local setpoint, the setpoint assumes the value of the remote setpoint at the time of switching.

Program control from panel:

In the absence of enabled digital inputs, alarms, M/A key (butt = 10, 11), program control engages when programmer state is displayed by using the Raise, Lower, and M/A keys.

Raise in stop = START; Lower in start = STOP; M/A pressed for 2 seconds = RESET (condition maintained with key pressed); Lower for 2 seconds in stop = enable change of programmer state.

When programmer state is not displayed, M/A key maintains function selected with "butt."

Programmer Reset Mode:

With standard function, when the control is active the setpoint takes on the value of the process variable and power is forced to zero. When parameter " _ _ r.t." is set to +16 and the reset control is active, the current setpoint (prior to reset) and power control are maintained. This function is applicable with reset from digital inputs or enabled keys, and also with reset following a program change (possible only in STOP) or from STOP/START switching at the end of a program.

Ripartenza with search of the step

The example shows a typical setpoint profile that can be programmed by setting a single 5-step program.

At start, if parameter Pty = 2 (in ProG), the program searches for the setpoint with value equal to PV.

The search is performed by moving the current time forward or backward, skipping phases or steps.

If the variable is lower than that required during a setpoint increase phase (point A, t1), at restart the current time base is lowered by intercepting the setpoint profile (point A1).

If the variable is lower than that required during a setpoint decrease phase (point B, t2), at restart the current time base is raised by intercepting the setpoint profile (point B1). If interception is not possible, as in the case of variable at PV1, program restart occurs at the current time and setpoint.

If the Hbb control is enabled, the programmer time base remains stopped until the variable re-enters the set tolerance band, symmetrically placed around the setpoint.

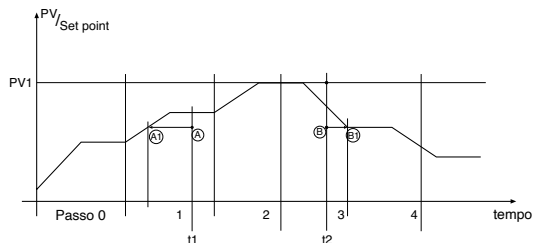

8 · STATE OF THE PROGRAMMER

EXAMPLE of programmer state display:

Program = 2, Step = 5, Segment = Hold, time elapsed = 20:42 (MM:SS)

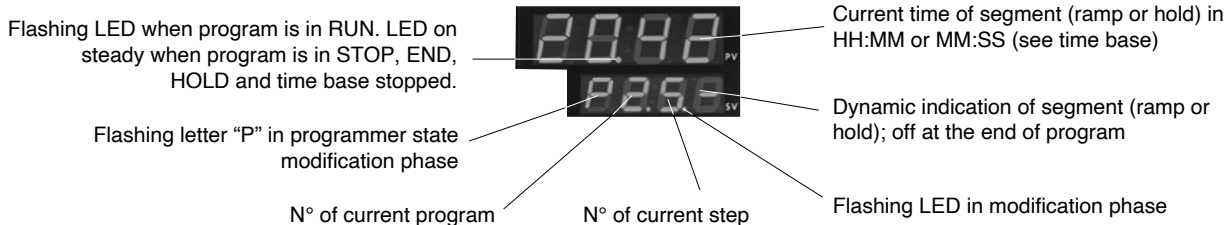

The setpoint can be changed directly from the keyboard only when the program is in STOP.

To change programmer state, press the "Lower" key for 2 seconds: the letter "P" will start flashing rapidly. Press key "F" to scroll: program, step, segment, time.

Flashing of the decimal point in each element indicates that the value is enabled for modification ("P" flashes slowly).

Use the "Raise" and "Lower" keys to set the required values. Press the "Lower" key for 2 seconds while "P" flashes rapidly or go to START to disable programmer state modification phase.

Program change automatically generates a reset.

Reset state is also entered by setting current step 0 (zero) and setting the current segment to "off" (lower right digit off).

Display / Modification of programmer state

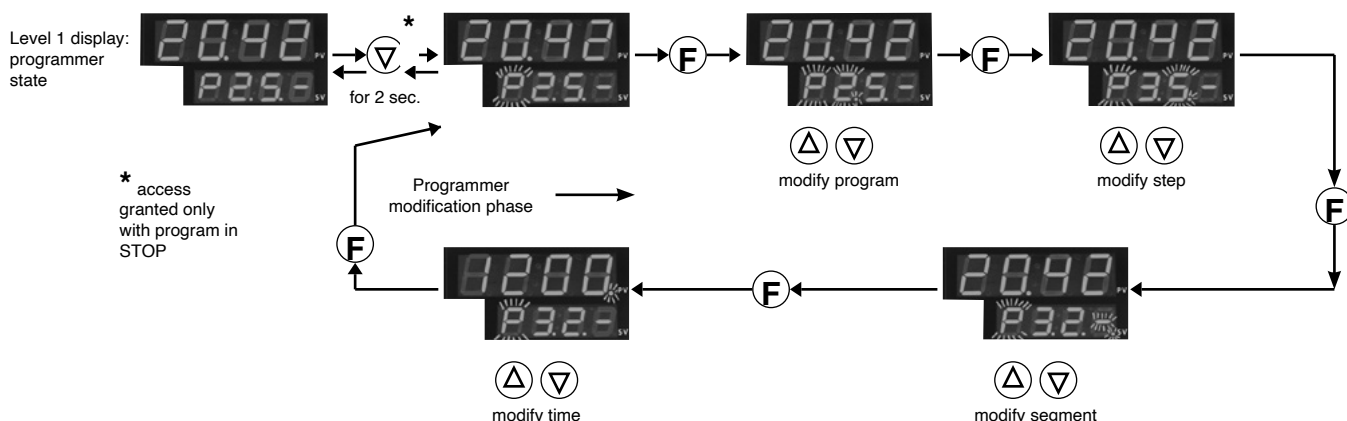

9 · ALARMS

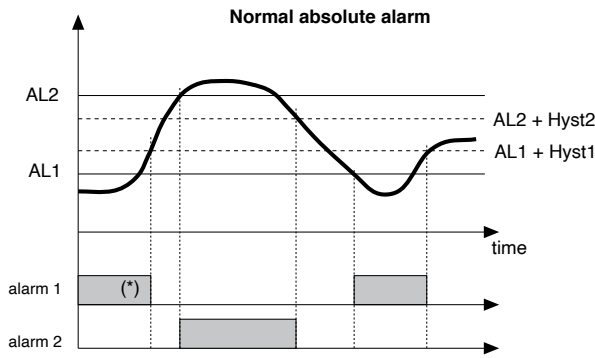

For AL1 = reverse absolute alarm (low) with positive Hyst1, AL1 t = 1
 (*) = OFF if disabled on power-up
 For AL2 = direct absolute alarm (high) with negative Hyst2, AL2 t = 0

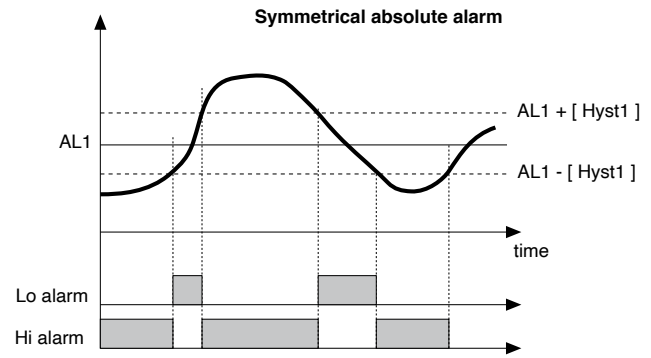

For AL1 = symmetrical Lo absolute alarm with Hyst1, AL1 t = 5
 For AL1 = symmetrical Hi absolute alarm with Hyst1, AL1 t = 4

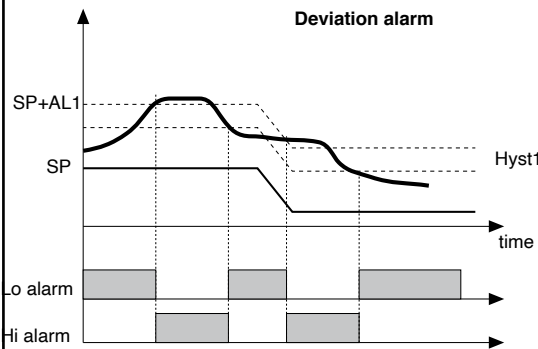

For AL1 = Lo deviation alarm with negative Hyst 1, AL1 t = 3
 For AL1 = Hi deviation alarm with negative Hyst 1, AL1 t = 2

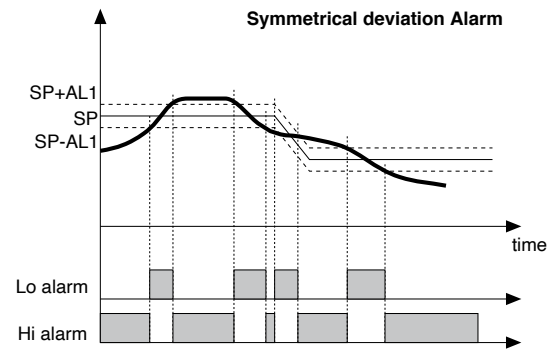

For AL1 = Symmetrical Lo deviation alarm with Hyst 1, AL1 t = 7
 For AL1 = Symmetrical Hi deviation alarm with Hyst 1, AL1 t = 6

ALARM HB

This type of alarm requires use of a current transformer input (CT).

It can indicate variations of load current measured through transformer input in the range (Lo.S2 ... HI.S2).

It is enabled by means of configuration code (Hrd, AL.nr); in this case the alarm setpoint is expressed as HB scale points.

The alarm function and the assigned control output are selected through parameter Hb_F ("Out" phase).

The alarm setpoint is AL.Hb.

The direct HB alarm trips if current transformer input falls below the setpoint for Hb_t seconds of ON time for the selected output.

The HB alarm can be activated only with ON times exceeding 0.4 seconds.

The HB alarm monitors load current even during the OFF period of the cycle time of the selected output.

The HB alarm will trip if measured current exceeds 12% of the CT input full scale for Hb_t seconds when the output is in OFF state.

The alarm is reset automatically when alarm conditions have been cleared.

If AL.Hb is set at = 0, both types of HB alarm are disabled and the assigned relay is de-energized.

The load current reading is displayed by selecting InP2 (level 1).

NOTE: ON/OFF times refer to the cycle time set for the selected output.

Alarm Hb_F = 3 (7), for analog output is ON when the load current is lower than the alarm setpoint; the alarm is disabled if the heating (cooling) output is lower than 2%.

ALARM LBA

This alarm detects an interruption in the control loop caused by a possible short-circuited probe, inverted probe connections or broken load.

If enabled (AL.nr), the alarm trips if the variable does not increase when heating (reduce when cooling) at maximum power for a set time (LbA.t).

The value of the variable is enabled only outside the proportional band; when the alarm is ON, power is limited to value (LbA.P).

The alarm condition resets as soon as temperature increases for heating (or reduces for cooling), or by simultaneously pressing the "▽" e "Δ" keys in Out.P of level 1.

The LBA function is disabled if LbA.t = 0.

10 · SOFT-START

This function (if enabled) partializes power in proportion to the time elapsed since power-up compared to the preset time 0.0 ... 500.0 min ("Soft" parameter, CFG). Soft-start is an alternative to self-tuning and is activated each time the unit is powered up. The soft-start function is reset by switching to Manual control.

11 • CONTROL ACTIONS

Proportional Action:

action in which contribution to output is proportional to deviation at input (deviation = difference between controlled variable and setpoint).

Derivative Action:

action in which contribution to output is proportional to rate of variation input deviation.

Integral Action:

action in which contribution to output is proportional to integral of time of input deviation.

Influence of Proportional, Derivative and Integral actions on response of process under control

- An increase in P.B. reduces oscillations but increases deviation.
 - A reduction in P.B. reduces the deviation but provokes oscillations of the controlled variable (the system tends to be unstable if P.B. value is too low).
 - An increase in Derivative Action corresponds to an increase in Derivative Time, reduces deviation and prevents oscillation up to a critical value of Derivative Time, beyond which deviation increases and prolonged oscillations occur.
 - An increase in Integral Action corresponds to a reduction in Integral Time, and tends to eliminate deviation between the controlled variable and the setpoint when the system is running at rated speed.
- If the Integral Time value is too long (Weak integral action), deviation between the controlled variable and the setpoint may persist.
Contact GEFRA for more information on control actions.

12 • MANUAL TUNING

- Enter the setpoint at its working value.
- Set the proportional band at 0.1% (with on-off type setting).
- Switch to automatic and observe the behavior of the variable. It will be similar to that in the figure:

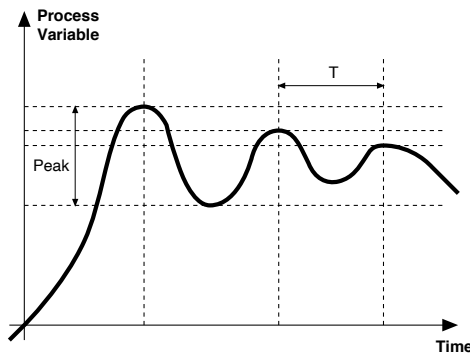

- The PID parameters are calculated as follows: Proportional band

$$P.B. = \frac{\text{Peak}}{V \text{ max} - V \text{ min}} \times 100$$

(V max - V min) is the scale range.

Integral time: $I_t = 1.5 \times T$

Derivative time: $d_t = I_t/4$

- Switch the unit to manual, set the calculated parameters. Return to PID action by setting the appropriate relay output cycle time, and switch back to Automatic.

- If possible, to optimize parameters, change the setpoint and check temporary response. If an oscillation persists, increase the proportional band. If the response is too slow, reduce it.

13 • SOFTWARE ON / OFF SWITCHING FUNCTION

How to switch the unit OFF: hold down the "F" and "Raise" keys simultaneously for 5 seconds to deactivate the unit, which will go to the OFF state while keeping the line supply connected and keeping the process value displayed. The SV display is OFF.

All outputs (alarms and controls) are OFF (logic level 0, relays de-energized) and all unit functions are disabled except the switch-on function and digital communication.

How to switch the unit ON: hold down the "F" key for 5 seconds and the unit will switch OFF to ON. If there is a power failure during the OFF state, the unit will remain in OFF state at the next power-up (ON/OFF state is memorized).

The function is normally enabled, but can be disabled by setting the parameter Prot = Prot +16. This function can be assigned to a digital input (d.i.F.1 or d.i.F.2) and excludes deactivation from the keyboard.

14 • SELF-TUNING

The function works for single output systems (heating or cooling).

The self-tuning action calculates optimum control parameter values during process startup.

The variable (for example, temperature) must be that assumed at zero power (room temperature).

The controller supplies maximum power until an intermediate value between starting value and setpoint is reached, after which it zeros power.

PID parameters are calculated by measuring overshoot and the time needed to reach peak. When calculations are finished, the system disables automatically and the control proceeds until the setpoint is reached.

How to activate self-tuning:

A. Activation at switch-on

1. Switch program to STOP
2. Adjust setpoint to required value
3. Enable self-tuning by setting **Stun** parameter to 2 (CFG menu)
4. Switch unit off
5. Make sure that temperature is approximately room temperature
6. Switch the unit on

B. Activation from keyboard

1. Make sure that M/A key is enabled for Start/Stop self-tuning function (**butt** code = 4 Hrd menu)
2. Switch program to STOP
3. Adjust temperature to approximately room temperature
4. Adjust setpoint to required value
5. Press M/A key to activate self-tuning (Attention: self-tuning will be disabled if the key is pressed again).

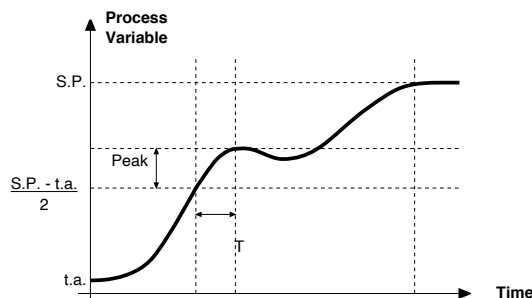

The procedure runs automatically until finished, when the new PID parameters are stored: proportional band, integral and derivative times calculated for the active action (heating or cooling). In case of double action (heating or cooling), parameters for the opposite action are calculated by maintaining the initial ratio between parameters (ex.: $CPb = HPb * K$; where $K = CPb / HPb$ when self-tuning starts). When finished, the Stun code is automatically cancelled.

Notes:

- The procedure interrupts when the setpoint value is exceeded. In this case, the **Stun** code is not cancelled.
- It is good practice to enable one of the configurable LEDs to signal self-tuning status. By setting one of LED1, LED2, LED3 = 3 (or 19) on the Hrd menu, the corresponding LED will be on (or flashing) when self-tuning is active.
- For the programmer model, the program is in STOP if self-tuning is activated when the unit is switched on.

15 • AUTO-TUNING

PID parameters cannot be set if the auto-tuning function is enabled.

The function can be one of two types: permanent or one-shot.

The first continuously measures system oscillations to find the optimum PID values to reduce such oscillations.

It does not engage if the oscillations drop below 1.0% of the proportional band.

It is interrupted if the setpoint is changed, and is automatically resumed when the setpoint stabilizes.

The calculated parameters are not stored.

If the unit is switched off, the controller reverts to the values set before auto-tuning was enabled.

One-shot auto-tuning is useful for calculating values around a setpoint. It produces a variation of 10% of current power at the output and examines the effect of the overshoot over time. These parameters are stored and replace those previously set. After this disturbance, the controller resumes control at the setpoint using the new parameters. The parameter activated in CFG is accepted only if the control power is between 20 and 80%.

16 • CONTROL OUTPUT

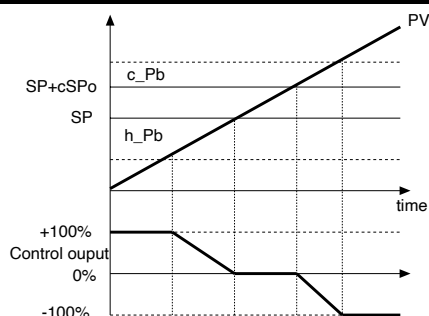

Control output with proportional action only if proportional heating band is separated from proportional cooling band.

PV = Process Value
SP+cSPo = Cooling Setpoint
c_Pb = Proportional cooling band

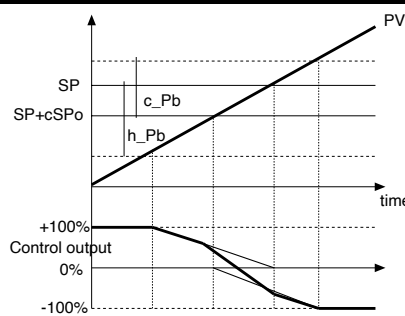

Control output with proportional action only if proportional heating band overlaps proportional cooling band

SP = Heating Setpoint
h_Pb = Proportional heating band

Heating/Cooling control with relative gain

In this control mode (enabled with CtrlL = 14 parameter) the type of cooling has to be specified.

Cooling PID parameters are therefore calculated based on heating parameters according to the specified ratio.

(for example: c.MEd = 1 (oil), H_Pb = 10, H_dt = 1, H_lt = 4 implies: $c_Pb = 12,5$, $C_dt = 1$, $C_lt = 4$)

We advise you to apply the following values when setting output cycle times:

- Air T Cool Cycle = 10 sec.
Oil T Cool Cycle = 4 sec.
Water T Cool Cycle = 2 sec.

NB.: Cooling parameters **cannot be modified** in this mode.

17 · MAIN INPUT CORRECTION FUNCTION

Lets you custom correct reading of the main input by setting four values: A1, B1, A2, B2.

This function is enabled by setting "Sens" +8 code ("Hrd" menu).

Example: Sens = 1+8 = 9 for RTD probe with input correction.

The scale can be reversed if this function is applied to linear scales (50mv, 10V, 20mA, Pot).

The four values are set on the "Lin" menu as follows: A1 = St100, B1 = St01, A2 = St02, B2 = St03. Setting is limited to the defined scale ("LoS" ... "HiS" on "InP" menu).

The offset function ("oFt" parameter on "InP" menu) remains enabled.

Limits:

B1 always greater than A1;

B1-A1 at least 25% of full scale of selected probe.

Example:

Sens = 9, TyPE = 0 (Pt100 natural scale -200...+600), dPS = 0

LoS = 0, HiS = 400, oFt = 0

Reference point on real curve: A1 = St00 = 50, B1 = St01 = 350 (B1-A1 = 300, greater than 25% of 800)

Corresponding points on corrected curve: A2 = St02 = 120, B2 = St03 = 220

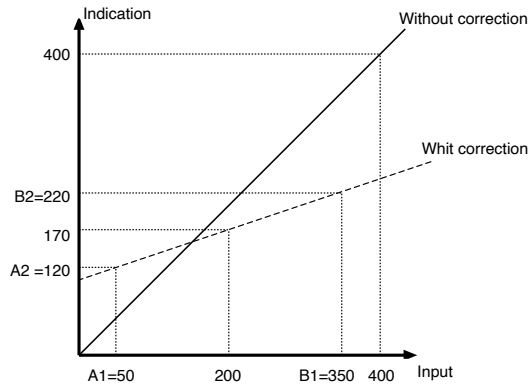

18 · ACCESSORIES

· CURRENT TRANSFORMERS

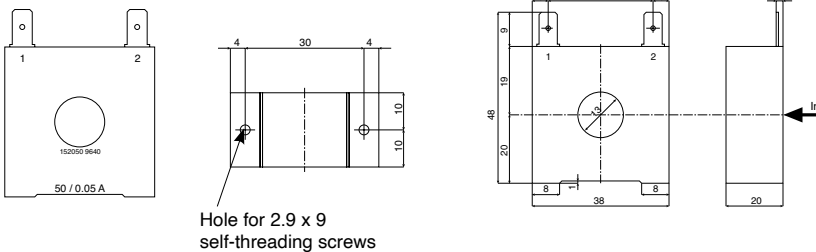

These transformers are used to measure currents of 50 ÷ 60Hz from 25A to 600A (nominal primary current). The peculiar characteristic of these transformers is the high number of secondary turns. This provides a very low secondary current, suitable for an electronic measurement circuit. The secondary current may be detected as voltage on a resistor.

· ORDER CODE

| CODE | Ip / Is | Ø Secondary Wire | n | OUTPUTS | Ru | Vu | ACCURACY |
|------------|------------|------------------|-------------------------|---------|------|-------|----------|
| TA/152 025 | 25 / 0.05A | 0.16 mm | n ¹⁻² = 500 | 1 - 2 | 40 Ω | 2 Vac | 2.0 % |
| TA/152 050 | 50 / 0.05A | 0.18 mm | n ¹⁻² = 1000 | 1 - 2 | 80 Ω | 4 Vac | 1.0 % |

| | |
|-------------|----------------------------|
| COD. 330200 | IN = 50Aac OUT = 50mAac |
| COD. 330201 | IN = 25Aac OUT = 50mAac |

· RS232 interface for instrument configuration

KIT PC USB / RS485 o TTL



Kit for PC via the USB port (Windows environment) for GEFran instruments configuration:

Lets you read or write all of the parameters

- A single software for all models
- Easy and rapid configuration
- Saving and management of parameter recipes
- On-line trend and saving of historical data

Component Kit:

- Connection cable PC USB ... port TTL
- Connection cable PC USB ... RS485 port
- Serial line converter
- CD SW GF Express installation

· ORDERING CODE

| | |
|--------------|-------------|
| GF_eXK-2-0-0 | cod F049095 |
|--------------|-------------|

ORDER CODE

800P



| OUTPUT 1 (MAIN) | |
|-----------------|----|
| Relé | R |
| D2 static | D* |

| OUTPUT 2 (AL1) | |
|----------------|----|
| Relé | R |
| D2 static | D* |

| OUTPUT 3 (AL2) | |
|----------------|----|
| None | 0* |
| Relé | R |
| D2 static | D |

| OUTPUT 4 (AL3) | |
|---------------------------|----|
| None | 0* |
| Relé | R |
| 0...10V analogue | V |
| 0...20, 4...20mA analogue | I |

| POWER SUPPLY | |
|--------------|-----------------------|
| 0 | 20...27Vac/Vdc ±10% |
| 1* | 100...240Vac/Vdc ±10% |

| DIGITAL COMMUNICATIONS | |
|------------------------|------------------|
| 0* | None |
| 2 | RS 485 / RS 232C |

| AUXILIARY INPUTS | |
|------------------|---------------------------|
| 0* | None |
| 1 | 0...1V |
| 2 | 0...10V / Potentiometer # |
| 3 | 0...20, 4...20mA |
| 5 | CT 50mAac |

| OUTPUT 5 - DIGITAL INPUTS IN1, IN2 - TRANSMITTER SUPPLY | |
|---|--|
| 00* | None |
| 01 | Output 5 analogue (W2) 0...10V |
| 02 | Output 5 analogue (W2) 0...20, 4...20mA |
| 03 | IN1, IN2 NPN; 10V transmitter supply 10V/24V |
| 04 | IN1, IN2 PNP; 10V transmitter supply 10V/24V |
| 05 | IIN1 NPN; 10V transmitter supply 10V/24V; Output 5 analogue (W2) 0...10V |
| 06 | IN1 PNP; 10V transmitter supply 10V/24V; Output 5 analogue (W2) 0...10V |
| 07 | IN1 NPN; 10V transmitter supply 10V/24V; Output 5 analogue (W2) 0...20, 4...20mA |
| 08 | IN1 PNP; 10V transmitter supply 10V/24V; Output 5 analogue (W2) 0...20, 4...20mA |

(*) Indicates standard version
Potentiometer input requires 10V supply

Note:
Digital input 2 is alternative to analogue output 2
Analogue output 2 is alternative to digital input 2

Make specific calibration request for PTC input.

Please, contact GEFTRAN sales people for the codes availability.

• WARNINGS



WARNING: this symbol indicates danger.
It is placed near the power supply circuit and near high-voltage relay contacts.

Read the following warnings before installing, connecting or using the device:

- follow instructions precisely when connecting the device.
- always use cables that are suitable for the voltage and current levels indicated in the technical specifications.
- the device has no ON/OFF switch: it switches on immediately when power is turned on. For safety reasons, devices permanently connected to the power supply require a two-phase disconnecting switch with proper marking. Such switch must be located near the device and must be easily reachable by the user. A single switch can control several units.
- if the device is connected to electrically NON-ISOLATED equipment (e.g. thermocouples), a grounding wire must be applied to assure that this connection is not made directly through the machine structure.
- if the device is used in applications where there is risk of injury to persons and/or damage to machines or materials, it MUST be used with auxiliary alarm units. You should be able to check the correct operation of such units during normal operation of the device.
- before using the device, the user must check that all device parameters are correctly set in order to avoid injury to persons and/or damage to property.
- the device must NOT be used in inflammable or explosive environments. It may be connected to units operating in such environments only by means of suitable interfaces in conformity to local safety regulations.
- the device contains components that are sensitive to static electrical discharges. Therefore, take appropriate precautions when handling electronic circuit boards in order to prevent permanent damage to these components.

Installation: installation category II, pollution level 2, double isolation

- power supply lines must be separated from device input and output lines; always check that the supply voltage matches the voltage indicated on the device label.
- install the instrumentation separately from the relays and power switching devices
- do not install high-power remote switches, contactors, relays, thyristor power units (particularly if "phase angle" type), motors, etc... in the same cabinet.
- avoid dust, humidity, corrosive gases and heat sources.
- do not close the ventilation holes; working temperature must be in the range of 0...50°C.

If the device has faston terminals, they must be protected and isolated; if the device has screw terminals, wires should be attached at least in pairs.

- **Power:** supplied from a disconnecting switch with fuse for the device section; path of wires from switch to devices should be as straight as possible; the same supply should not be used to power relays, contactors, solenoid valves, etc.; if the voltage waveform is strongly distorted by thyristor switching units or by electric motors, it is recommended that an isolation transformer be used only for the devices, connecting the screen to ground; it is important for the electrical system to have a good ground connection; voltage between neutral and ground must not exceed 1V and resistance must be less than 60Ω; if the supply voltage is highly variable, use a voltage stabilizer for the device; use line filters in the vicinity of high frequency generators or arc welders; power supply lines must be separated from device input and output lines; always check that the supply voltage matches the voltage indicated on the device label.

• **Input and output connections:** external connected circuits must have double insulation; to connect analog inputs (TC, RTD) you have to: physically separate input wiring from power supply wiring, from output wiring, and from power connections; use twisted and screened cables, with screen connected to ground at only one point; to connect adjustment and alarm outputs (contactors, solenoid valves, motors, fans, etc.), install RC groups (resistor and capacitor in series) in parallel with inductive loads that work in AC (*Note: all capacitors must conform to VDE standards (class x2) and support at least 220 VAC. Resistors must be at least 2W*); fit a 1N4007 diode in parallel with the coil of inductive loads that operate in DC.

GEFRAN spa will not be held liable for any injury to persons and/or damage to property deriving from tampering, from any incorrect or erroneous use, or from any use not conforming to the device specifications.

PONTICELLI PER CONFIGURAZIONE
JUMPERS FOR CONFIGURATION
BRÜCKEN FÜR KONFIGURATION

PONTS ÉTAÏN POUR CONFIGURATION
PUNTES PARA CONFIGURACIÓN
PONTES PARA CONFIGURAÇÃO

Struttura dello strumento: identificazione schede
 Device structure: identification of boards
 Aufbau des Instruments: Leiterplatten
 Structure de l'appareil: identification des cartes
 Estructura del instrumento: identificación fichas
 Estrutura do instrumento: identificação das placas

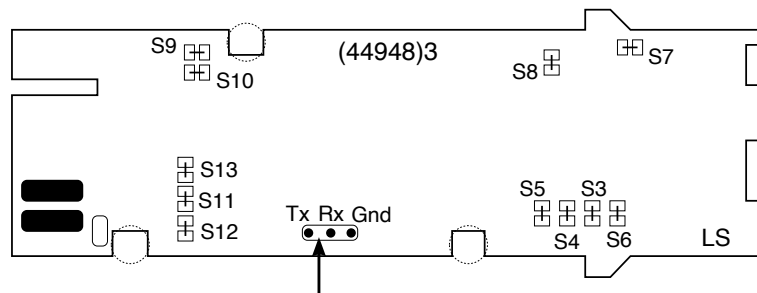

SCHEDA CPU
 CPU BOARD
 CPU-KARTE
 CARTE CPU
 FICHA CPU
 PLACA CPU

Connettore per collegamento seriale
 Connector for serial connection
 Steckverbinder für seriellen Anschluss
 Connecteur pour raccordement série
 Conector para conexión serie
 Conector para ligação serial

| DESCRIZIONE DESCRIPTION BESCHREIBUNG | PONTICELLI JUMPERS BRÜCKEN |
|---|---|
| Abilitazione configurazione Enable configuration Freigabe der Konfiguration | S3 (chiuso) S3 (closed) S3 (geschlossen) |
| Abilitazione calibrazione Enable calibration Freigabe der Kalibration | S4 (chiuso) S4 (closed) S4 (geschlossen) |
| OUT3 relé diseccitato power ON OUT3 relay OFF at power ON Ausgang 3; Relais angezogen = Kontakt geöffnet | S9 (chiuso) S9 (closed) S9 (geschlossen) |
| OUT3 relé eccitato power ON OUT3 relay ON at power ON Ausgang 3; Relais angezogen = Kontakt geschlossen | S10 (chiuso) S10 (closed) S10 (geschlossen) |
| Non utilizzato Not used Nicht verwendet | S7 (chiuso) S7 (closed) S7 (geschlossen) |
| Abilitazione ingresso da potenziometro Enable input from potentiometer Freigabe des Potentiometereingangs | S11 (chiuso) S11 (closed) S11 (geschlossen) |
| Abilitazione ingresso da potenziometro Enable input from potentiometer Freigabe des Potentiometereingangs | S12 (chiuso) S12 (closed) S12 (geschlossen) |
| Abilitazione sonda PTC Enable PTC probe Freigabe Fühler PTC | S13 (aperto) S13 (open) S13 (geöffnet) |
| Abilitazione sonda PT100 Enable PT100 probe Freigabe Fühler PT100 | S13 (chiuso) S13 (closed) S13 (geschlossen) |

| DESCRIPTION DESCRIPCIÓN DESCRIÇÃO | PONTS ÉTAIN PUENTES PONTES |
|---|--|
| Validation configuration Habilitación configuración Habilitação da configuração | S3 (fermée) S3 (cerrado) S3 (fechado) |
| Validation étalonnage Habilitación calibración Habilitação da calibração | S4 (fermée) S4 (cerrado) S4 (fechado) |
| OUT3 relais désexcité mise en marche OUT3 relé desexcitado con "power ON" OUT3 relé não excitado com alimentação ON | S9 (fermée) S5 (cerrado) S9 (fechado) |
| OUT3 relais excité mise en marche OUT3 relé excitado con "power ON" OUT3 relé excitado com alimentação ON | S10 (fermée) S10 (cerrado) S10 (fechado) |
| Non utilisé No utilizado Não utilizado | S7 (fermée) S7 (cerrado) S7 (fechado) |
| Validation entrér par potentiomètre Habilitación entrada desde potenciómetro Habilitação entrada proveniente do potenciômetro | S11 (fermée) S11 (cerrado) S11 (fechado) |
| Validation entrér par potentiomètre Habilitación entrada desde potenciómetro Habilitação entrada proveniente do potenciômetro | S12 (fermée) S12 (cerrado) S12 (fechado) |
| Validation capteur PTC Habilitación sonda PTC Habilitação para sonda PTC | S13 (ouverte) S13 (abierto) S13 (aberto) |
| Validation capteur PT100 Habilitación sonda P100 Habilitação para sonda PT100 | S13 (fermée) S13 (cerrado) S13 (fechado) |

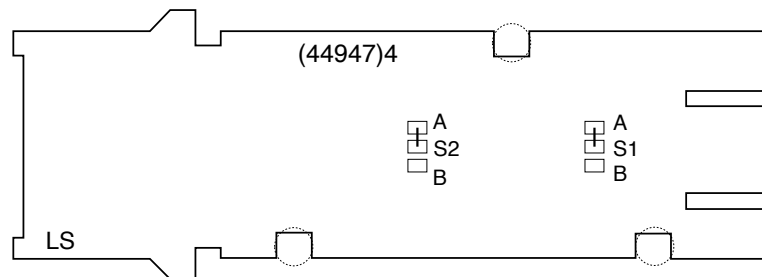

SCHEDA POWER 90/260
POWER BOARD 90/260
NETZTEIL-KARTE 90/260

CARTE ALIMENTATION 90/260
FICHA ALIMENTACIÓN 90/260
PLACA DE ALIMENTAÇÃO 90/260

| DESCRIZIONE DESCRIPTION BESCHREIBUNG DESCRIPTION DESCRIPCIÓN DESCRIÇÃO | PONTICELLI JUMPERS BRÜCKEN PONTS ÉTAIN PUENTES PONTES |
|---|--|
| OUT2 relè disexcitato power ON OUT2 relay OFF at power ON Ausgang 2; Relais angezogen = Kontakt geöffnet OUT2 relais désexcité mise en marche OUT2 relé desexcitado con "power ON" OUT2 relé não excitado com alimentação ON | S1 (posizione A) S1 (position A) S1 (Stellung A) S1 (position A) S1 (posición A) S1 (posição A) |
| OUT2 relè eccitato power ON OUT2 relay ON at power ON Ausgang 2; Relais angezogen = Kontakt geschlossen OUT2 relais excité mise en marche OUT2 relé excitado con "power ON" OUT2 relé excitado com alimentação ON | S1 (posizione B) S1 (position B) S1 (Stellung B) S1 (position B) S1 (posición B) S1 (posição B) |

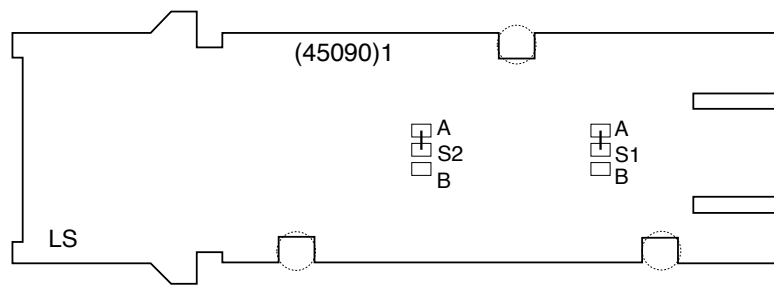

SCHEDA POWER 10/30
 POWER BOARD 10/30
 NETZTEIL-KARTE 10/30
 CARTE ALIMENTATION 10/30
 FICHA ALIMENTACIÓN 10/30
 PLACA DE ALIMENTAÇÃO 10/30

| DESCRIZIONE DESCRIPTION BESCHREIBUNG DESCRIPCION DESCRICÃO | PONTICELLI JUMPERS BRÜCKEN PONTS ÉTAIN PUENTES PONTES |
|---|--|
| OUT2 relè diseccitato power ON OUT2 relay OFF at power ON Ausgang 2; Relais angezogen = Kontakt geöffnet OUT2 relais désexcité mise en marche OUT2 relé desexcitado con "power ON" OUT2 relé não excitado com alimentação ON | S1 (posizione A) S1 (position A) S1 (Stellung A) S1 (position A) S1 (posición A) S1 (posição A) |
| OUT2 relè eccitato power ON OUT2 relay ON at power ON Ausgang 2; Relais angezogen = Kontakt geschlossen OUT2 relais excité mise en marche OUT2 relé excitado con "power ON" OUT2 relé excitado com alimentação ON | S1 (posizione B) S1 (position B) S1 (Stellung B) S1 (position B) S1 (posición B) S1 (posição B) |

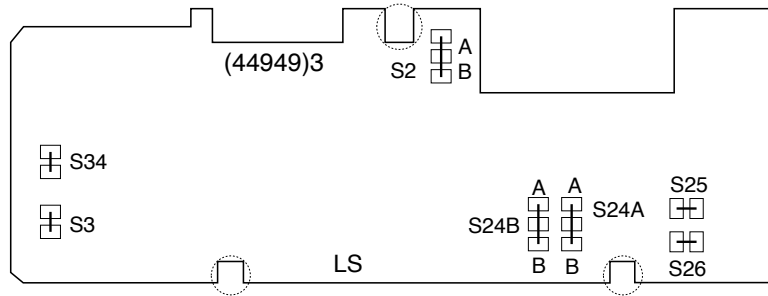

SCHEDA OUT W / INGRESSI DIGITALI
OUT W BOARD / DIGITAL INPUTS
ANALOG AUSGÄNGE / DIGITALE EINGÄNGE
CARTE OUT W / ENTREES NUMERIQUES
FICHA OUT W / ENTRADAS DIGITALES
PLACA OUT W / ENTRADAS DIGITAIS

| DESCRIZIONE DESCRIPTION BESCHREIBUNG DESCRIPTION DESCRIPCIÓN DESCRIÇÃO | PONTICELLI JUMPERS BRÜCKEN PONTS ÉTAIN PUESTES PONTES |
|---|--|
| OUT4 relè diseccitato power ON OUT4 relay OFF at power ON Ausgang 4; Relais angezogen = Kontakt geöffnet OUT4 relais désexcité mise en marche OUT4 relé desexcitado con "power ON" OUT4 relé não excitado com alimentação ON | S2 (posizione A) S2 (position A) S2 (Stellung A) S2 (position A) S2 (posición A) S2 (posição A) |
| OUT4 relè eccitato power ON OUT4 relay ON at power ON Ausgang 4; Relais angezogen = Kontakt geschlossen OUT4 relais excité mise en marche OUT4 relé excitado con "power ON" OUT4 relé excitado com alimentação ON | S2 (posizione B) S2 (position B) S2 (Stellung B) S2 (position B) S2 (posición B) S2 (posição B) |
| Selezione ingresso logico 1 NPN Selection of 1 NPN logic input Wahl des Digital-Eingangs 1 NPN Sélection entrée logique 1 NPN Selección entrada lógica 1 NPN Seleção entrada lógica 1 NPN | S24A (posizione A) S24A (position A) S24A (Stellung A) S24A (position A) S24A (posición A) S24A (posição A) |
| Selezione ingresso logico 1 PNP Selection of 1 PNP logic input Wahl des Digital-Eingangs 1 PNP Sélection entrée logique 1 PNP Selección entrada lógica 1 PNP Seleção entrada lógica 1 PNP | S24A (posizione B) S24A (position B) S24A (Stellung B) S24A (position B) S24A (posición B) S24A (posição B) |
| Selezione ingresso logico 2 NPN Selection of 2 NPN logic input Wahl des Digital-Eingangs 2 NPN Sélection entrée logique 2 NPN Selección entrada lógica 2 NPN Seleção entrada lógica 2 NPN | S24B (posizione A) S24B (position A) S24B (Stellung A) S24B (position A) S24B (posición A) S24B (posição A) |
| Selezione ingresso logico 2 PNP Selection of 2 PNP logic input Wahl des Digital-Eingangs 2 PNP Sélection entrée logique 2 PNP Selección entrada lógica 2 PNP Seleção entrada lógica 2 PNP | S24B (posizione B) S24B (position B) S24B (Stellung B) S24B (position B) S24B (posición B) S24B (posição B) |

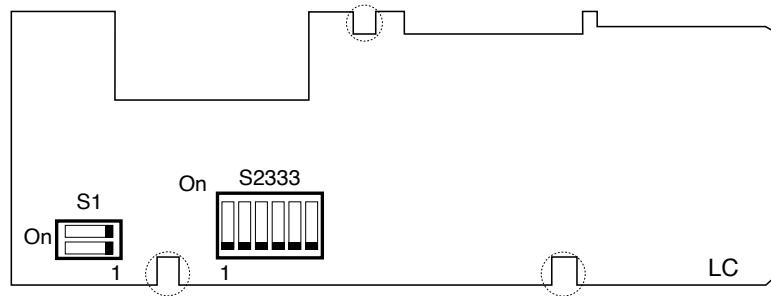

USCITA ANALOGICA W1 (DIP SWITCHES S2333)
 ANALOGUE OUTPUT W1 (DIP SWITCHES S2333)
 ANALOGER AUSGANG W1 (DIP SWITCHES S2333)
 SORTIE ANALOGIQUE W1 (DIP SWITCHES S2333)
 SALIDA ANALÓGICA W1 (DIP SWITCHES S2333)
 SAÍDA ANALÓGICA W1 (DIP SWITCHES S2333)

| TIPO USCITA OUTPUT TYPE AUSGANGSTYP TYPE SORTIE TIPO DE SALIDA TIPO DE SAÍDA | SELEZIONE ON SELECTION ON WAHL ON SELECTION ON SELECCIÓN ON SELEÇÃO ON | SELEZIONE OFF SELECTION OFF WAHL OFF SELECTION OFF SELECCIÓN OFF SELEÇÃO OFF |
|---|---|---|
| 0/4...20mA | 5 | 4-6 |
| 0...10V | 4-6 | 5 |

USCITA ANALOGICA W2 (DIP SWITCHES S2333)
 ANALOGUE OUTPUT W2 (DIP SWITCHES S2333)
 ANALOGER AUSGANG W2 (DIP SWITCHES S2333)
 SORTIE ANALOGIQUE W2 (DIP SWITCHES S2333)
 SALIDA ANALÓGICA W2 (DIP SWITCHES S2333)
 SAÍDA ANALÓGICA W2 (DIP SWITCHES S2333)

| TIPO USCITA OUTPUT TYPE AUSGANGSTYP TYPE SORTIE TIPO DE SALIDA TIPO DE SAÍDA | SELEZIONE ON SELECTION ON WAHL ON SELECTION ON SELECCIÓN ON SELEÇÃO ON | SELEZIONE OFF SELECTION OFF WAHL OFF SELECTION OFF SELECCIÓN OFF SELEÇÃO OFF |
|---|---|---|
| 0/4...20mA | 2 | 1-3 |
| 0...10V | 1-3 | 1 |

USCITA ALIMENTAZIONE TRASMETTITORE (DIP SWITCHES S1)
 TRANSMITTER SUPPLY OUTPUT (DIP SWITCHES S1)
 AUSGANG FÜR SENSORSPEISUNG (DIP SWITCHES S1)
 SORTIE DE ALIMENTATION POUR
 TRANSMETTEUR (DIP SWITCHES S1)
 SALIDA DE ALIMENTACIÓN PARA TRANSMISOR (DIP SWITCHES S1)
 SAÍDA DE ALIMENTAÇÃO PARA TRANSMISSOR (DIP SWITCHES S1)

| TIPO USCITA OUTPUT TYPE AUSGANGSTYP TYPE SORTIE TIPO DE SALIDA TIPO DE SAÍDA | SELEZIONE ON SELECTION ON WAHL ON SELECTION ON SELECCIÓN ON SELEÇÃO ON | SELEZIONE OFF SELECTION OFF WAHL OFF SELECTION OFF SELECCIÓN OFF SELEÇÃO OFF |
|---|---|---|
| 0V | - | 1-2 |
| 10V | 2 | 1 |
| 24V | 1 | 2 |

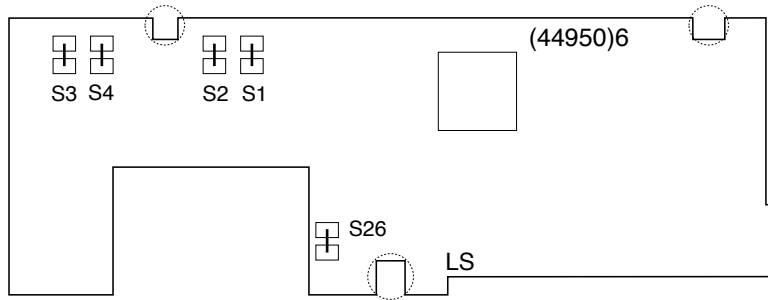

SCHEDA SERIALE / SPR
 SERIAL BOARD
 KARTE FÜR DIE SERIELLE ÜBERTRAGUNG
 CARTE SÉRIE
 FICHA SERIE
 PLACA DE COMUNICAÇÃO DIGITAL

| INGRESSO SPR SPR INPUT SPR EINGANG ENTREE SPR ENTRADA ENTRADA | PONTICELLI (chiusi) JUMPERS (closed) BRÜCKEN (geschlossen) PONTS ÉTAIN (fermées) PUENTES (cerrados) PONTES (fechados) | PONTICELLI (aperti) JUMPERS (open) BRÜCKEN (geöffnet) PONTS ÉTAIN (ouvertes) PUENTES (abiertos) PONTES (abertos) |
|--|--|---|
| 0/4...20mA | S4-S26 | S1-S2-S3 |
| 0...10V / Potenziometro Potentiometer Potentiometer Potentiomètre Potenciómetro Potenciômetro | S1-S26 | S2-S3-S4 |
| TA 50mAac | S2-S3-S4 | S1-S26 |

GEFRAN

GEFRAN spa

via Sebina, 74 - 25050 Provaglio d'Iseo (BS) - ITALIA

Tel. +39 0309888.1 - Fax +39 0309839063

www.gefran.com

www.gefranonline.com