



MAIN FEATURES

- Pressure ranges from: 0-17 a 0-2000 bar/0-250 a 0-30000 psi
- Extensimetric measurement principle
- Accuracy: $< \pm 0.25\%$ FS (H); $< \pm 0.5\%$ FS (M)
- SIL2 and PL d approvals for Functional Safety
- Ex certifications for potentially explosive atmospheres (see details)
- Completely interchangeable with all existing products
- Protection level: IP66 (6-pin connector)
- 1/2-20UNF, M18x1.5 standard threads; other types available on request
- Standard diaphragm is 15-5 PH stainless steel with GTP+ coating
- 17-7 PH corrugated stainless steel diaphragm with GTP+ coating for ranges below 100 bar-1500 psi
- Other diaphragm types available on request

HMX0 The rigid rod configuration provides fast and easy installation.

HMX1 The flexible rod configuration is suitable for applications demanding greater thermal isolation and where installation would otherwise be difficult.

HMX2 This configuration lets you measure process pressure and temperature at the same point with a single installation.

HMX3 The configuration with exposed tip is ideal for applications in limited space.

HMX4 Configuration with flange for specific applications.

Main intrinsic safety characteristics

Transmitters are designed and produced in compliance with:

- _ ATEX Directive 2014/34/EU
- _ IECEx scheme
- _ EAC TR CU 012/2011 regulation
- _ KCs regulation
- _ Nepsi Ex regulation
- _ PESO CCoE regulation

Type of Protection:

- _ ATEX: group II, category 1G, 1D
- GAS type of protection: Ex ia IIC T6, T5, T4 Ga (Ambient Temp.: -20°C...+60°C / +75°C / +85°C)
- DUST type of protection: Ex ia IIIC T₂₀₀85°C, T₂₀₀100°C, T₂₀₀110°C Da IP65 (Ambient Temp.: -20°C...+60°C / +75°C / +85°C)

_ IECEx/KCs/Nepsi Ex/PESO:

- group II, category 1G
- GAS type of protection: Ex ia IIC T6, T5, T4 Ga (Ambient Temp.: -20°C...+60°C / +75°C / +85°C)

_ EAC Ex:

- group/category 0
- GAS type of protection: Ex ia IIC T6, T5, T4 Ga (Ambient Temp.: -20°C...+60°C / +75°C / +85°C)
- DUST type of protection: Ex ia IIIC T85°C, T100°C, T135°C
- Da IP65 (Ambient Temp.: -20°C...+60°C / +75°C / +85°C)

The HMX series of Gefran are pressure transmitters with HART communication protocol for using in high temperature environment with explosive atmosphere presence.

The main characteristic of this series is the capability to read pressure of the media up to 400°C.

The constructive principle is based on the hydraulic transmission of the pressure.

The fluid-filled system assures the temperature stability. The physical measure is transformed in a electrical measure by means of strain-gauge technology.

The SIL2 and PL d approvals make the product suitable for use in the Functional Safety applications, particularly in the process plants for the production of polymers, where it is an essential requirement.

TECHNICAL SPECIFICATIONS

Accuracy (1)	H $< \pm 0.25\%$ FS (100...2000 bar) M $< \pm 0.5\%$ FS (17...2000 bar)
Resolution	16 bit
Measurement range	0..17 to 0..2000bar 0..250 to 0..30000psi
Rangeability	3:1
Maximum overpressure (without degrading performances)	2 x FS 1.5 x FS above 1000bar/15000psi
Measurement principle	Extensimetric thick film
Power supply	13...30Vdc
Maximum current absorption	23mA
Output signal Full Scale (FS)	20mA
Zero balance (tolerance $\pm 0.25\%$ FS)	4mA
Calibration signal	80% FS
Power supply polarity reverse protection	YES
Compensated temperature range housing	0...+85°C
Operating temperature range housing	-30...+85°C
Storage temperature range housing	-40...+125°C
Thermal drift in compensated range: Zero / Calibration / Sensibility	$< 0.02\%$ FS/°C
Diaphragm maximum temperature	400°C / 750°F
Zero drift due to change in process temperature (zero)	< 0.02 bar/°C
Standard material in contact with process medium	Diaphragm: • 15-5 PH with GTP+ coating • 17-7 PH corrugated diaphragm with GTP+ coating for ranges < 100 bar (1500psi) Stem: • 17-4 PH
Thermocouple (model HMX2)	STD: type "J" (isolated junction)
Protection degree (with 6-pole female connector CON300)	IP66
SIL2 certification PL d certification	IEC/EN 62061 - IEC 61508 EN ISO 13849
FS = Full scale output For products sold to EAC Customs Union (EAC mark), due to a different method of calculation, the limits of accuracy are the following: _ M = $\pm 1\%$ _ H = $\pm 0,5\%$ (1) BFSL method (Best Fit Straight Line): includes combined effects of Non-Linearity, Hysteresis and Repeatability (according to IEC 62828-2)	

Maximum voltage	30 V
Maximum current	100 mA
Maximum power	0,75 W
Maximum inductance (*)	17 μ H
Maximum capacity (*)	10 nF
(*) includes inductance levels and capacity of a cable: (typical L 1 microH/m and typical C 100pF/m) with maximum length 15m.	

The Melt pressure transmitters must be connected to other equipment (galvanic isolation barriers) with individual Ex certification such as [Ex ia Ga] IIC. The thermocouple circuit must be powered by means of galvanic isolation barriers with a maximum of 30V. EU-Type Examination Certificate number: **DNV 21 ATEX 81471**
IECEX CoC number: **PRE 20.0091**
EAC Ex number: **C-IT.A.107.B.02919/20**
KCs certificate number: **21-KA4BO-0668 (HMX)**
Nepsi Ex number: **GYJ21.2886X**
PESO approval number: **A/P/HQ/MH/104/6921 (P520346)**

MECHANICAL DIMENSIONS

HMX0

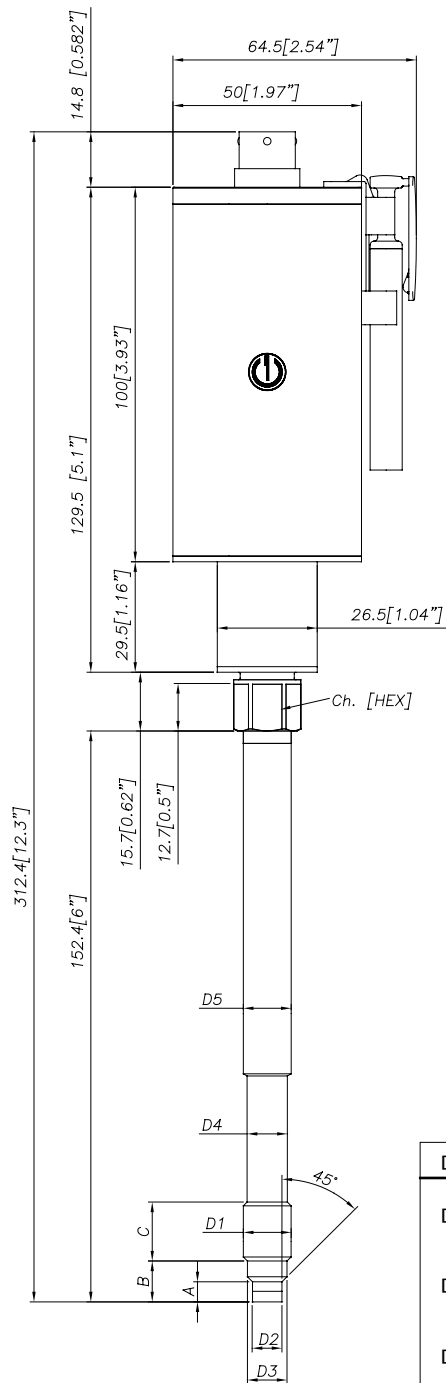

HMX1

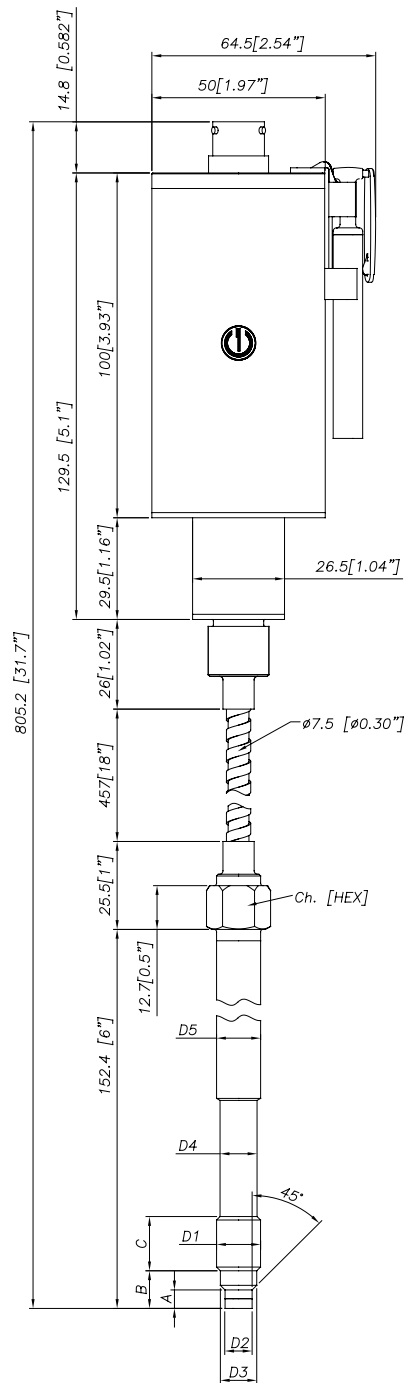

D1	1/2 - 20UNF	D1	M18x1.5
D2	ø7.8 -0.05 [ø0.31" -0.002]	D2	ø10 -0.05 [ø0.394" -0.002]
D3	ø10.5 -0.025 [ø0.41" -0.001]	D3	ø16 -0.08 [ø0.63" -0.003]
D4	ø10.67 [ø0.42"]	D4	ø16 -0.4 [ø0.63" -0.016]
D5	ø12.7 [ø0.5"]	D5	ø18 [ø0.71"]
A	5.56 -0.26 [0.22" -0.01]	A	6 -0.26 [0.24" -0.01]
B	11.2 [0.44"]	B	14.8 -0.4 [0.58" -0.016]
C	15.74 [0.62"]	C	19 [0.75"]
Ch [Hex]	16 [5/8"]	Ch [Hex]	19 [3/4"]

NOTE: dimensions refer to rigid stem length option "4" (153 mm– 6")

WARNING: For installation use a maximum tightening torque of 56 Nm (500 in-lb)

MECHANICAL DIMENSIONS

HMX2

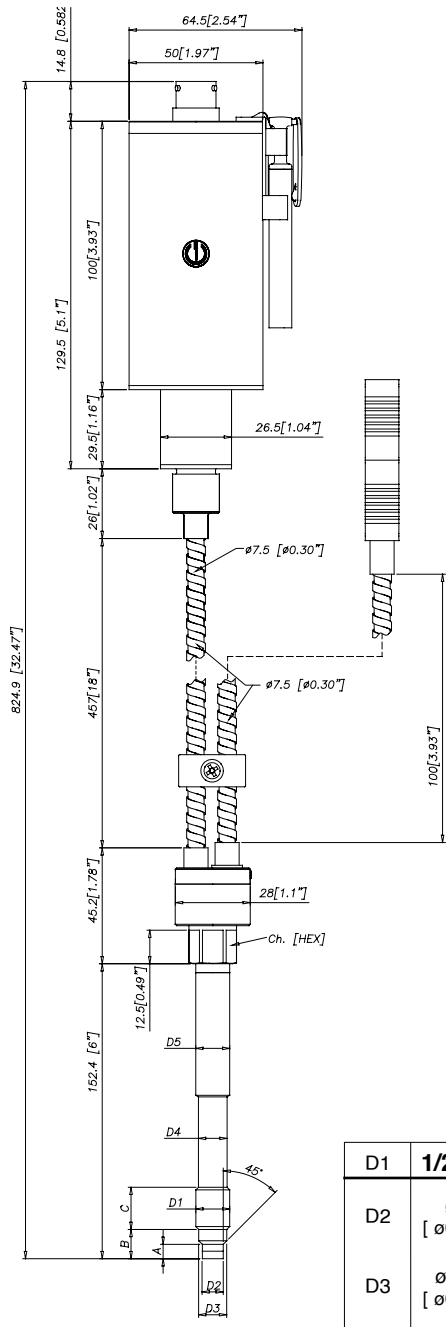

HMX3

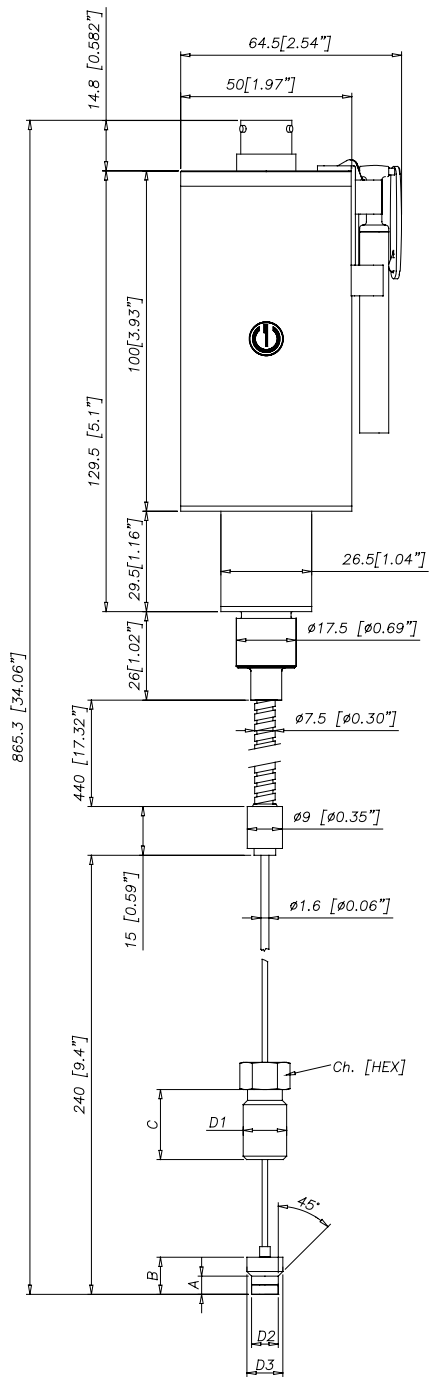

D1	1/2 - 20UNF	D1	M18x1.5
D2	ø7.8 -0.05 [ø0.31" -0.002]	D2	ø10 -0.05 [ø0.394" -0.002]
D3	ø10.5 -0.025 [ø0.41" -0.001]	D3	ø16 -0.08 [ø0.63" -0.003]
D4	ø10.67 [ø0.42"]	D4	ø16 -0.4 [ø0.63" -0.016]
D5	ø12.7 [ø0.5"]	D5	ø18 [ø0.71"]
A	5.56 -0.26 [0.22" -0.01]	A	6 -0.26 [0.24" -0.01]
B	11.2 [0.44"]	B	14.8 -0.4 [0.58" -0.016]
C	15.74 [0.62"]	C	19 [0.75"]
Ch [Hex]	16 [5/8"]	Ch [Hex]	19 [3/4"]

NOTE: dimensions refer to rigid stem length option "4" (153 mm– 6")

WARNING: For installation use a maximum tightening torque of 56 Nm (500 in-lb)

MECHANICAL DIMENSIONS

HMX4

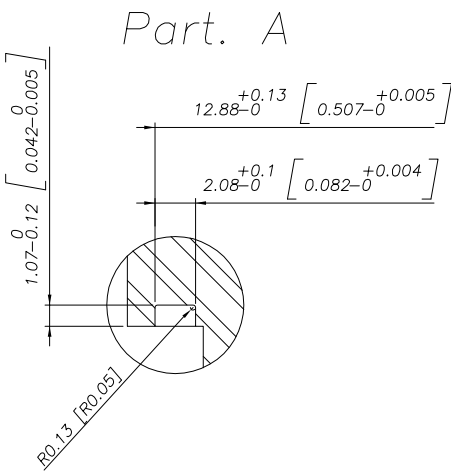
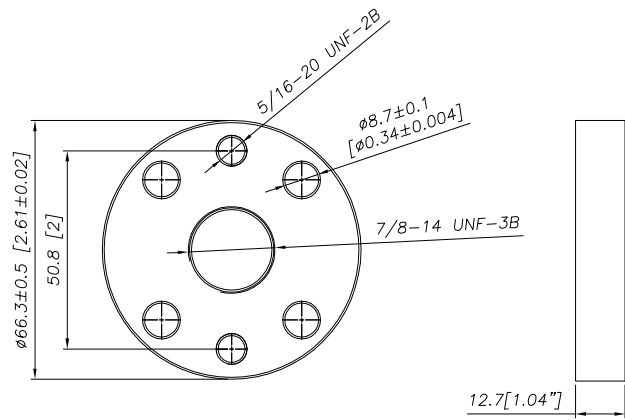
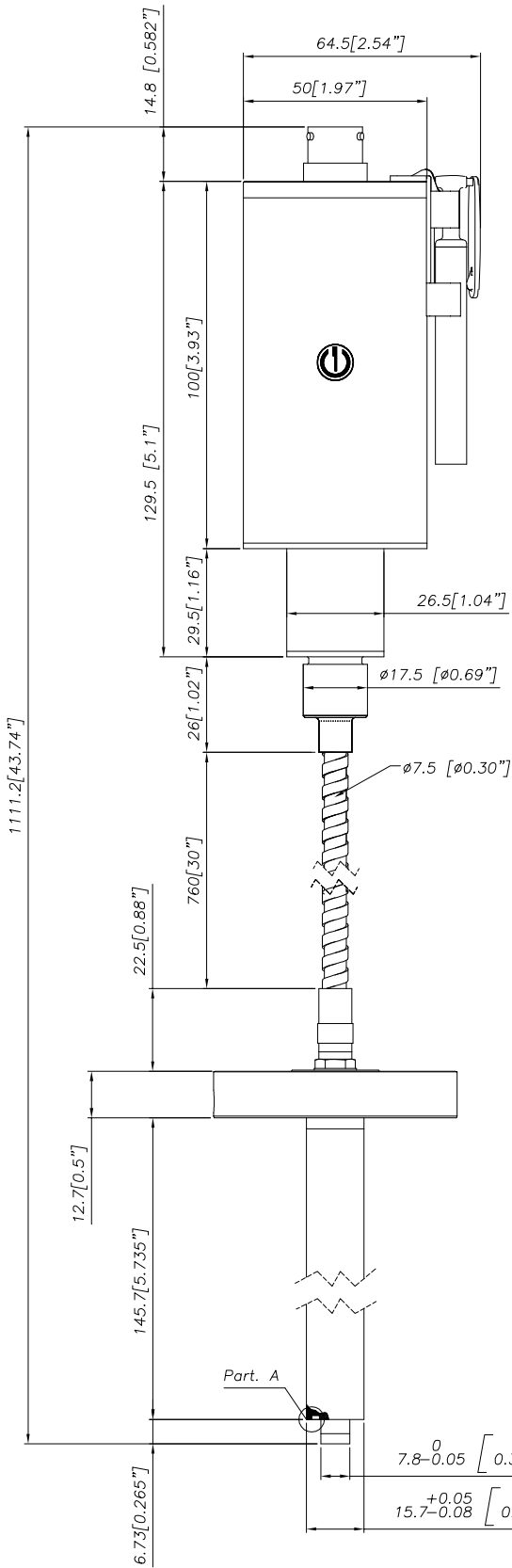

NOTE: dimensions refer to rigid stem length option "4" (153 mm-6")

SELF DIAGNOSTICS (ONLY FOR SIL2 / PL d VERSIONS)

Below the conditions detected by the sensor self-diagnostics:

- Cut cable / device non connected / broken power supply, output $\leq 3.6\text{mA}$
- Pin detachment output $\leq 3.6\text{mA}$
- Broken primary element $\geq 21\text{mA}$
- Pressure above 200% of the span, output $\geq 21\text{mA}$
- Voltage monitor in case of overvoltage/undervoltage/voltage variation in the electronics, output $\leq 3.6\text{mA}$ (*)
- Program sequence error, output $\leq 3.6\text{mA}$ (*)
- Overtemperature on the electronics, output $\leq 3.6\text{mA}$ (*)
- Error on the primary element output or on the first amplification stage, output $\geq 21\text{mA}$

(*) In such conditions the Alarm Type can be programmed via HART at $\geq 21\text{mA}$.

NAMUR COMPLIANCE (ONLY FOR SIL2 / PL d VERSIONS)

The sensors are tested according to Namur NE21 recommendations. The same compatibility is valid for the NE43 Namur recommendation with the following sensor behaviour in case of breakdown:

- Cut cable: breakdown information as the signal is $\leq 3.6\text{mA}$
- Device not connected: breakdown information as the signal is $\leq 3.6\text{mA}$
- Broken power-supply: breakdown information as the signal is $\leq 3.6\text{mA}$
- or in case of performance problems:
- Broken primary element $\geq 21\text{mA}$
- Pressure above 200% of the span, output $\geq 21\text{mA}$
- Others $\leq 3.6\text{mA}$ (*)

(*) In such a condition the Alarm Type can be programmed via HART at $\geq 21\text{mA}$.

Note: in all the remaining situations, the output signal is always included between 3.8 and 20.5mA.



Recommendation: the error level set by the customer (e.g. maximum pressure value) has to be inside the nominal range.

LOAD DIAGRAM

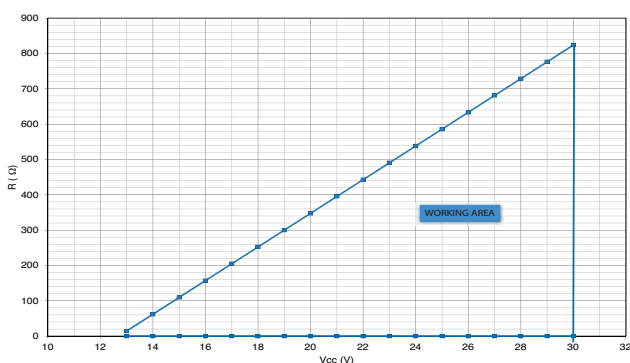

The diagram shows the optimum ratio between load and power supply for transmitters with 4...20mA output. For correct function, use a combination of load resistance and voltage that falls within the two lines in the graph above.

AUTOZERO FUNCTION

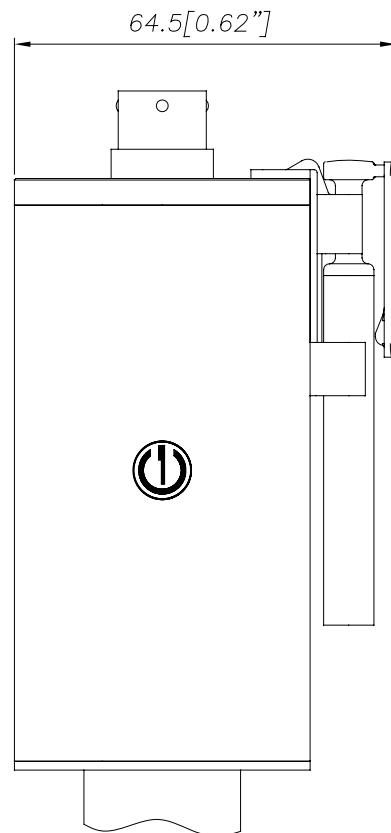

The Autozero function is activated through a magnetic contact (external magnet supplied with the sensor). The Autozero function can be activated through HART command as well. See the manual for a complete Autozero function explanation.

ELECTRICAL CONNECTIONS

CURRENT OUTPUT

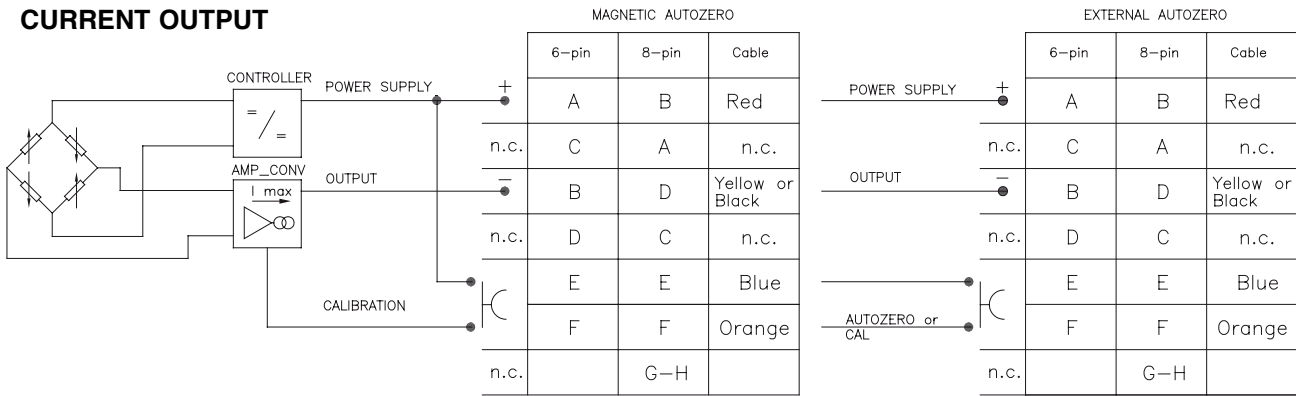

The cable shield is tied to both sides, i.e. to the sensor connector and to the controller

**6 pin Connector
VPT07RA10-6PT2
(PT02A-10-6P)**

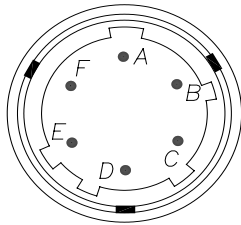

**8 pin Connector
(PC02E-12-8P) Bendix**

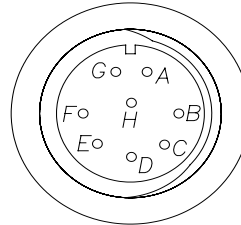

**Cable outlet (1/2 14-NPT)
Current output
L = 1 m**

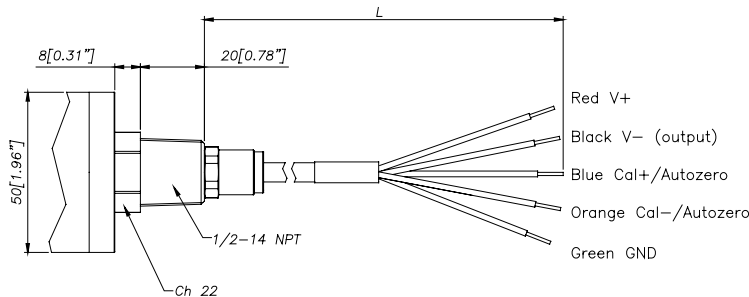

ACCESSORIES

Connectors

6-pin female connector (IP66 protection degree)
8-pin female connector

Accessories

Mounting bracket
Dummy plug for 1/2-20UNF
Dummy plug for M18x1.5
Drill kit for 1/2-20UNF
Drill kit for M18x1.5
Cleaning kit for 1/2-20UNF
Cleaning kit for M18x1.5
Fixing pen clip
Autozero pen

Extension cables

6-pin connector with 3mt Atex cable
6-pin connector with 4mt Atex cable
6-pin connector with 5mt Atex cable
6-pin connector with 10mt Atex cable

Thermocouples for model HMX2

Type "J" (for rigid rod 153mm - 6")

CON300
CON307

SF18
SC12
SC18
KF12
KF18
CT12
CT18
PKIT1032
PKIT378

PCAV221
PCAV104
PCAV105
PCAV106

TTER 601

Cable color code	
Conn.	Wire
A-2	Red
B-4	Black
C-1	White
D-6	Green
E-7	Blue
F-3	Orange
5	Grey
8	Pink

PROCESS FLANGE ADAPTER

The process flange adapter is a sensor accessory that allows for the installation of 1/2-20 UNF or M18x1.5 melt pressure sensor in a button seal style process mounting port. The adapter is made with an adapter body with different snout lengths plus an adapter flange available in different sizes (see tables and drawing below). Each combination of snout and flange is available according to the ordering information with a specific ordering code.

SPECIFICATIONS

- Pressure range: according to the selected sensor (up to 1000 bar/15000 psi max)
- Temperature range: according to the selected sensor
- Material of construction: 17-4PH Stainless steel

ADAPTER BODY

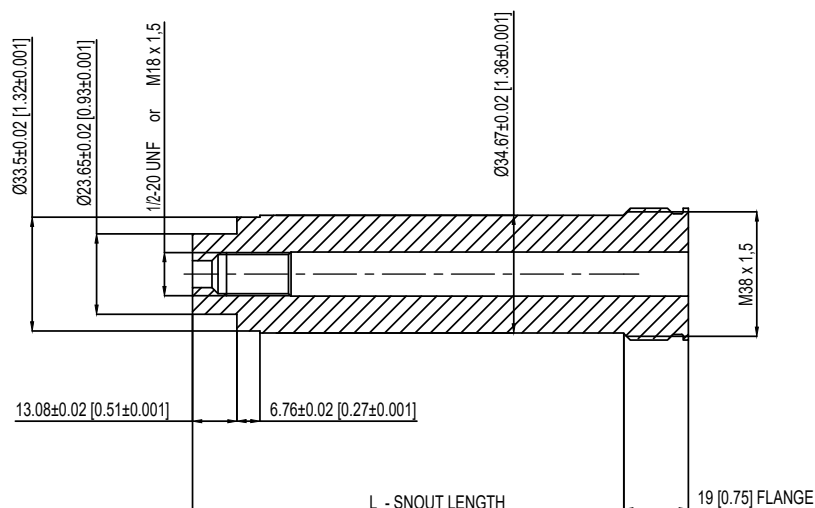

1/2-20 UNF	L - SNOOT LENGTH
STE1020	127 [5]
STE1021	51,6 [2,031]

M18 X 1,5	L - SNOOT LENGTH
STE1022	127 [5]
STE1023	51,6 [2,031]

ADAPTER FLANGE

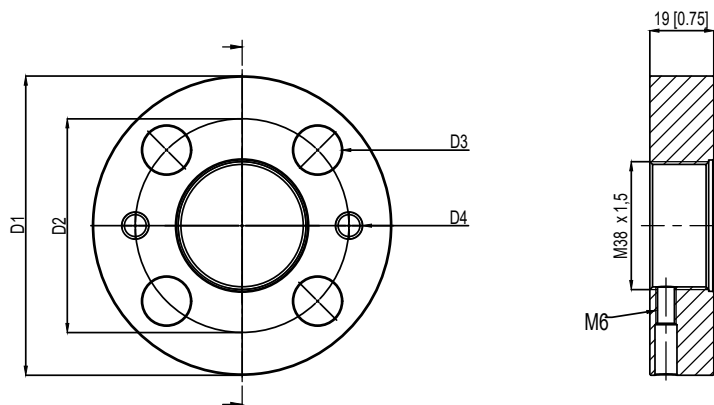

	FLA960	FLA961
D1	82,6 [3,25]	88,9 [3,50]
D2	54 [2,14]	63,5 [2,50]
D3	13,2 [0,52]	14,3 [0,56]
D4	5/16-18 UNC	5/16-18 UNC

ORDER CODE

KIT - 5 - 0 - 1

Snout length	
5 inch [127 mm]	5
2,031 inch [51,6 mm]	2

Flange type (see technical drawing)	
FLA960	0
FLA961	1

Thread dimensions	
1/2-20 UNF	1
M18 x 1,5	4

ADAPTER GASKETS			
Material	Dimensions	Max Pressure	Ord. Code
Aluminium	30.2 mm [1.19"] OD 24.1 mm [.950"] ID	200 bar/3000 psi	RON360
AISI 303 SS	30.2 mm [1.19"] OD 24.1 mm [.950"] ID	700 bar/10000 psi	RON361

Example:

KIT501

Process adapter with 5" snout length, 82.6 mm size flange, suitable for 1/2-20 UNF melt sensor

ORDER CODE

HM - - - - - - - - - -

000 0 X 000 X 0

OUTPUT SIGNAL	
4...20mA	X

VERSION	
Rigid rod	0
Rigid + flexible rod	1
With thermocouple	2
Exposed capillary	3
Flange mounting	4

CONNECTOR	
6 pin	6
8 pin	8
NPT Cable	N

ACCURACY CLASS	
0.25% FS (ranges \geq 100 bar/1500 psi)	H
0.5% FS	M

MEASUREMENT RANGE			
bar		psi	
17	B17U	250	P25D
35	B35U	500	P05C
50	B05D	750	P75D
70	B07D	1000	P01M
100	B01C	1500	P15C
200	B02C	3000	P03M
350	B35D	5000	P05M
500	B05C	7500	P75C
700	B07C	10000	P10M
1000	B01M	15000	P15M
1400	B14C	20000	P20M
2000	B02M	30000	P30M

THREADING	
Standard	
1/2 - 20 UNF	1
M18 x 1.5	4
Flange mounting ϕ 66.3mm (2.61")	6
Available on request	
M10 x 1.0	2
M14 x 1.0	3

0	ATEX Approval
I	IECEX Approval
E	EAC Ex Approval
K	KCs Approval
N	Nepsi Ex Approval
P	PESO Approval

(*) For further requirements contact info@gefran.com

000= Special executions

	ATEX	EAC Ex	IECEX/KCs/ Nepsi Ex/ PESO	Tamb
4	T4/T ₂₀₀ 110°C	T4/T135°C	T4	-20°C/+85 °C
5	T5/T ₂₀₀ 100°C	T5/T100°C	T5	-20°C/+75 °C
6	T6/T ₂₀₀ 85°C	T6/T85°C	T6	-20°C/+60 °C

E	External Autozero (*)
0	Magnetic Autozero

(*) as an alternative to the CAL function

P	Performance Level='d'
S	SIL2
0	Standard 4...20mA

FLEXIBLE ROD LENGTH (mm/inches)	
Standard (HMX0)	
0	none
Standard (HMX1, HMX2, HMX4)	
D	457mm / 18"
E	610mm / 24"
F	760mm / 30"
Standard (HMX3)	
L	711mm / 28"
Available on request	
A	76mm / 3"
B	152mm / 6"
C	300mm / 12"
G	914mm / 36"
H	1067mm / 42"
I	1220mm / 48"
J	1372mm / 54"
K	1520mm / 60"

RIGID ROD LENGTH (mm/inches)	
Standard (HMX0, HMX1, HMX2)	
4	153mm / 6"
5	318mm / 12.5"
Standard (HMX3)	
0	none
Available on request	
1	38mm / 1.5"
2	50mm / 2"
3	76mm / 3"
6	350mm / 14"
7	400mm / 16"
8	456mm / 18"
Standard (HMX4)	
4	153mm / 6"
Available on request	
H	102mm / 4"
M	229mm / 9"
5	305mm / 12"

Example

HMX1-6-M-B07C-1-4-D-0-0-4

Melt pressure transmitter, 4...20mA output with HART protocol, 6-pin connector, 1/2-20 UNF threading, 700 bar pressure range, 0.5% accuracy, 153 mm (6") rigid rod, 457 mm (18") flexible rod, temperature class T4 (-20°C...+85°C).

Sensors are manufactured in compliance with:

- EMC compatibility directive: 2014/30/EU
- MACHINERY directive: 2006/42/EC
- Ex Regulations (see page 1)

Product designed and available in compliance with Directive 2011/65/EU (RoHS II) only for large-scale stationary installation or industrial tools, or for B-to-B laboratory equipments for R&D purposes.

Electrical installation requirements and conformity certificate are available on our web site: www.gefran.com

GEFRAN spa reserves the right to make any kind of design or functional modification at any moment without prior notice.

GEFRAN spa

via Sebina, 74

25050 PROVAGLIO D'ISEO (BS) - ITALIA

tel. 0309888.1 - fax. 0309839063

Internet: <http://www.gefran.com>

GEFRAN

DTS_HMX Ex_12-2021_ENG