



The MX4 series of GEFran, are pressure transmitters for using in High temperature environment.

The main characteristic of this series is the capability to read temperature of the media up to 400°C.

The constructive principle is based on the hydraulic transmission of the pressure.

The fluid-filled system assures the temperature stability. The physical measure is transformed in a electrical measure by means the strain-gauge technology.

### MAIN FEATURES

- Pressure ranges: 0-25 to 0-2000bar / 0-360 to 0-30000psi
- Extensimetric measurement principle with Wheatstone bridge
- Precision: <math>\pm 0.25\% \text{ FSO (H)}</math>; <math>\pm 0.5\% \text{ FSO (M)}</math>
- Calibration signal 80% FSO internally generated
- Completely interchangeable with all existing products
- Protection level: IP65 (6-pin connector)
- Flange Mounting
- Stainless steel diaphragm 15-5 PH with GTP+
- For ranges below 100bar-1500psi: 17-7 PH corrugated stainless steel diaphragm with GTP+ coating
- Other diaphragm types available on request

### TECHNICAL SPECIFICATIONS

Rated precision, including effects of Linearity, Repeatability and Hysteresis	<b>H</b> <math>\pm 0.25\% \text{ FSO}</math> (100...2000 bar) <b>M</b> <math>\pm 0.5\% \text{ FSO}</math> (25...2000 bar)
Resolution	Infinite
Pressure ranges	0...25 to 0...2000bar 0...360 to 0...30000psi
Maximum applicable pressure	2 x FS 1,5 x FS beyond 1000bar/15000psi
Principle of measurement	Strain gauge
Power supply	12...30Vdc
Maximum input	30mA
Isolation resistance (at 50 Vdc)	> 1000 MΩ
Signal at rated pressure (FSO)	20mA
Zero balancing	4mA
Calibration:	Rated pressure Room pressure
	5% FSO min. 10bar (150psi)
Maximum load	see diagram (page 3)
Response time (10 at 90% FSO)	~ 4ms
Output noise (RMS 10-400Hz)	<math>< 0.05\% \text{ FSO}</math>
Calibration signal	80% FSO
Protection against overvoltages and power supply polarity reverse	YES
Temperature range of Strain Gauge Housing	-20...+70°C -4...+158°F
Thermal drift in compensated range: Zero/Calibrat/Sensitivity	<math>< 0.02\% \text{ FSO}/^{\circ}\text{C}</math> <math>< 0.01\% \text{ FSO}/^{\circ}\text{F}</math>
Maximum temperature of diaphragm	400°C / 750°F
Influence due to fluid temperature change (zero)	0.02 bar/°C 15 psi/100°F
Standard material in contact with process medium	Diaphragm: • 15-5 PH with GTP+ coating • 17-7 PH corrugated diaphragm with GTP+ coating for ranges <math>< 100 \text{ bar}</math> (1500psi) Stem: • 17-4 PH
Sealing	Copper washer silver plated
Protection level (with 6-pin female connector installed)	IP65
Electrical connections	6-pin conn. VPT07RA10-6PT (PT02A-10-6P) 8-pin conn. PC02E-12-8P

FSO = Full Scale Output (Signal at rated pressure)

#### Main intrinsic safety characteristics

Transmitter designed and produced in compliance with Directive ATEX 2014/34/EU and according to European standards. For the second group (II-surfaces), category 1, explosive atmosphere with presence of gases, fumes or mists (G) protection mode Ex ia IIC T5, T4 room temperature -20°C/+55°C/+70°C

Maximum voltage	30 V
Maximum current	100 mA
Maximum power	0,75 W
Equivalent inductance (*)	0,23 mH
Equivalent capacity (*)	26 nF

(\*) includes inductance levels and capacity of a cable:  
(typical L 1microH/m and typical C 100pF/m) with maximum length 15m.

Power at zener barrier or active barrier. For version MX2, the thermocouple must be connected to EX-i circuits with devices assigned to galvanic separation and with protection mode [EX ia] IIC.



EC-Type Examination Certificate number:  
**CESI 02 ATEX 107**

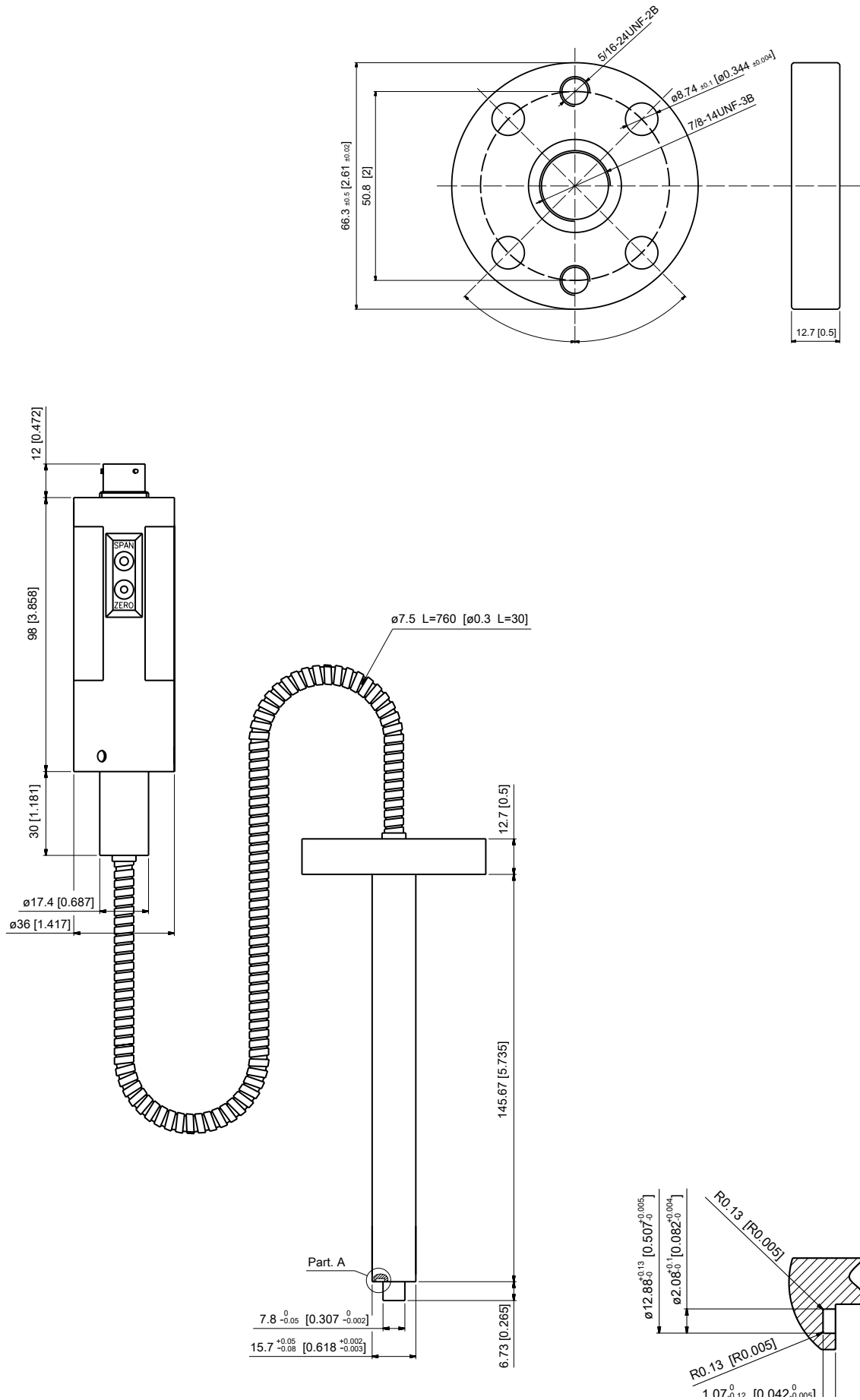

# MECHANICAL DIMENSIONS



## ELECTRICAL CHARACTERISTICS AND TEMPERATURE CLASSES

MODEL	(*) DISTANCE L2	TEMPERATURE CLASSES	ROOM TEMPERATURE
MX4	> 785mm	T5 T4	-20...+55°C -20...+70°C

(\*) with the level (L) in fig. 1, the table sets the minimum distance that the electrical circuit has to maintain from the block at high temperature.

-  thermal isolating material with adequate thickness for the process temperature
-  installation Vs process
-  fluid at temperature Max. (400°C)

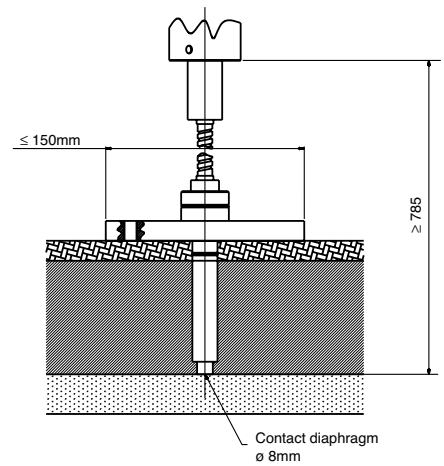

## ELECTRICAL CONNECTIONS

*Output in current (4...20mA 2 wires)*

	6-pin	8-pin
Power supply (12...30Vdc) +	A	B
n.c.	C	A
Signal (4...20mA) -	B	D
n.c.	D	C
Calibration shunt	E - F	E - F
n.c.		G - H

The cable sheathing is connected to the transducer body

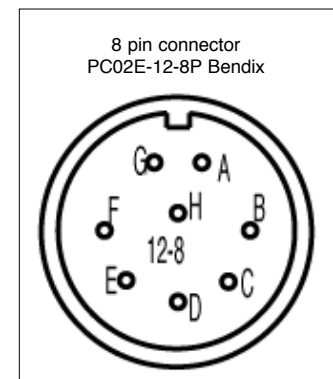
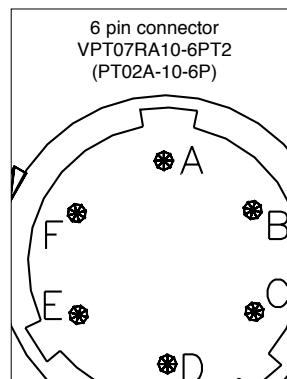

## LOAD DIAGRAM (current output)

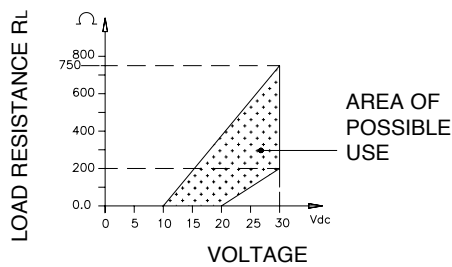

The diagram shows the best ratio of load to power supply for transmitters with 4...20mA output. For correct function, use a combination of load resistance and voltage that stays in the shaded zone.

## SETTINGS

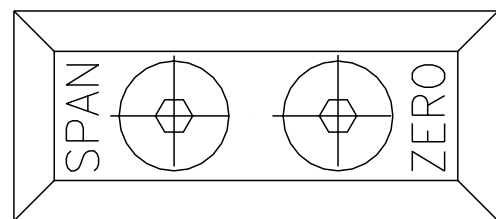

The signal setting to room pressure (ZERO) and the setting to rated pressure (SPAN) can be made with the appropriate trimmers, accessed inside the transmitter after removing the two fastening screws.

**The SPAN setting is made during production and must not be changed.**

### Accessories

Mounting bracket  
Copper washer silver plated

### Extension cables

<b>SF18</b>	6-pin connector with 3mt Atex cable	<b>PCAV221</b>
<b>RON007</b>	6-pin connector with 4mt Atex cable	<b>PCAV104</b>
	6-pin connector with 5mt Atex cable	<b>PCAV105</b>
	6-pin connector with 10mt Atex cable	<b>PCAV106</b>

## ORDER CODE

**M** - - - - - - - - - - **000**

000= Special executions of the standard version or of custom versions may be requested.

OUTPUT SIGNAL	
4...20mA	<b>X</b>

<b>4</b>	T4
<b>5</b>	T5

CONFIGURATION	
Flange mounting	<b>4</b>

FLEXIBLE ROD LENGTH		
<b>F</b>	760mm	30"

CONNECTOR	
<b>Standard</b>	
6 pin	<b>6</b>
8 pin	<b>8</b>

RIGID ROD LENGTH (mm / inches)		
<b>Standard</b>		
<b>4</b>	153mm	6"
<b>Available on request</b>		
<b>H</b>	102mm	4"
<b>M</b>	229mm	9"
<b>5</b>	305mm	12"

PRECISION CLASS	
<b>0.25% FSO</b> (ranges $\geq 100$ bar/1500 psi)	<b>H</b>
<b>0.5% FSO</b>	<b>M</b>

FLANGE MOUNTING	
<b>Standard</b>	
<b>6</b>	$\varnothing$ 66.3mm (2.61")

MEASUREMENT RANGE			
bar		psi	
<b>25</b>	<b>B25U</b>	<b>360</b>	<b>P36D</b>
<b>35</b>	<b>B35U</b>	<b>500</b>	<b>P05C</b>
<b>50</b>	<b>B05D</b>	<b>750</b>	<b>P75D</b>
<b>70</b>	<b>B07D</b>	<b>1000</b>	<b>P01M</b>
<b>100</b>	<b>B01C</b>	<b>1500</b>	<b>P15C</b>
<b>200</b>	<b>B02C</b>	<b>3000</b>	<b>P03M</b>
<b>350</b>	<b>B35D</b>	<b>5000</b>	<b>P05M</b>
<b>500</b>	<b>B05C</b>	<b>7500</b>	<b>P75C</b>
<b>700</b>	<b>B07C</b>	<b>10000</b>	<b>P10M</b>
<b>1000</b>	<b>B01M</b>	<b>15000</b>	<b>P15M</b>
<b>1400</b>	<b>B14C</b>	<b>20000</b>	<b>P20M</b>
<b>2000</b>	<b>B02M</b>	<b>30000</b>	<b>P30M</b>

Example

### **MX4-6-M-B07C-6-4-F-4-000**

Melt pressure transducer with flange mounting, 4...20mA output, 6-pin connector, pressure range 700bar, precision class 0.5%, 153mm (6") rigid rod, 760mm (30") flexible rod, temperature class T4.

Sensors are manufactured in compliance with:  
 - EMC compatibility directive  
 - ATEX

Product designed and available in compliance with Directive 2011/65/EU (RoHS II) only for large-scale stationary installation or industrial tools, or for B-to-B laboratory equipments for R&D purposes.

Electrical installation requirements and Conformity certificate are available on our web site: [www.gefran.com](http://www.gefran.com)

GEFRAN spa reserves the right to make aesthetic or functional changes at any time and without notice.

**GEFRAN**

**GEFRAN spa**  
 via Sebina, 74 - 25050 PROVAGLIO D'ISEO (BS) - ITALIA  
 tel. +39 030 9888.1 - fax. +39 030 9839063  
<http://www.gefran.com>

DTS\_MX4\_07-2017\_ENG