



INSTALLATION AND OPERATION MANUAL

SOFTWARE VERSION 3.2x
code **80085G** / Edit 14 - 04-2013

1 • INSTALLATION

• Dimensions and cut-out; panel mounting

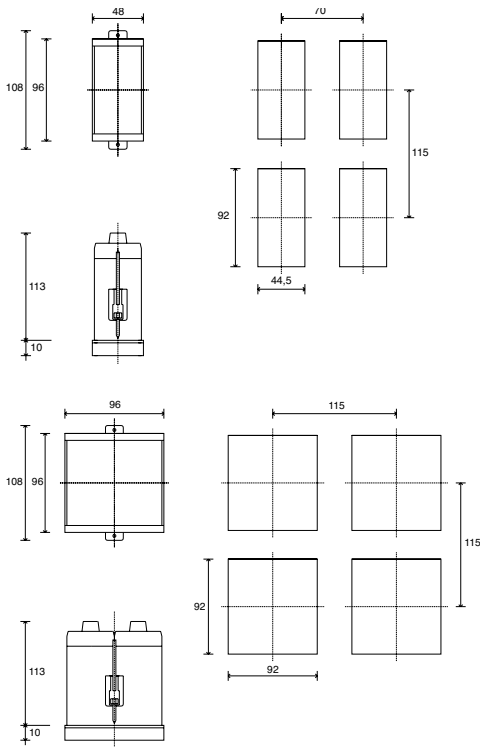

For correct and safe installation, follow the instructions and observe the warnings contained in this manual.

Panel mounting:

To fix the unit, insert the brackets provided into the seats on either side of the case. To mount two or more units side by side, respect the cut-out dimensions shown in the drawing. To obtain IP65 faceplate protection level, remove the device from the box, apply the gasket (supplied) with adhesive to the front edge of the box, and then reinsert the device.

CE MARKING: The instrument conforms to the European Directives 2004/108/CE and 2006/95/CE with reference to the generic standards: **EN 61000-6-2** (immunity in industrial environment) **EN 61000-6-3** (emission in residential environment) **EN 61010-1** (safety) Limitations: model 1800V conforms to Standard EN61000-6-4 for emissions radiated in industrial environment.

MAINTENANCE: Repairs must be done only by trained and specialized personnel. Cut power to the device before accessing internal parts.

Do not clean the case with hydrocarbon-based solvents (Petrol, Trichlorethylene, etc.). Use of these solvents can reduce the mechanical reliability of the device. Use a cloth dampened in ethyl alcohol or water to clean the external plastic case.

SERVICE: GEFran has a service department. The warranty excludes defects caused by any use not conforming to these instructions.

2 • TECHNICAL SPECIFICATIONS

Display	2 x 4 digits, green, height: 10 and 7 mm (1600V); 20 and 13 mm (1800V)
Keys	5 mechanical keys (-, Man/Aut, INC, DEC, F)
Accuracy	0.2% full scale at 25°C room temperature
Main input	TC, RTD (Pt100 - JPT100), PTC, 50mV, Ri ≥ 1MΩ; 10V, Ri ≥ 10KΩ; 20mA, Ri = 50Ω
Thermocouples	IEC 584-1 (J, K, R, S, T, B, E, N, Ni-Ni18Mo, L NiCr-CuNi)
Cold junction error	0,1° / °C
RTD type (scale configurable within indicated range, with or without decimal point)	DIN 43760 (Pt100, JPT100)
PTC type (on request)	990Ω, 25°C
Max line resistance for RTD	20Ω
Safety	detection of short-circuit or opening of probes, LBA alarm, HB alarm
°C / °F selection	configurable from faceplate
Linear scale ranges	-1999 to 9999 with configurable decimal point position
Controls	PID, Self-tuning, on-off
pb / dt / di	0.0 ... 999.9% / 0.00 ... 99.99min / 0.00 ... 99.99min
Action	Heat / Cool
Control outputs	on / off, pwm, Open / Close
Cycle time	0.1 ... 200 sec
Main output type	Relay, Logic, Continuous (optional)
Softstart	0.0 ... 500.0 min
Maximum power limit heat / cool	0.0 ... 100.0 %
Fault power setting	-100.0 ... 100.0 %
Automatic blanking	Optional exclusion, displays PV value
Configurable alarms	3 configurable alarms type: max, min, symmetrical, absolute or relative, LBA, HB
Alarm masking	- exclusion during warm up - latching reset from faceplate or external contact
Type of relay contact	NO (NC), 5A, 250V, cosφ = 1
Logic output for static relays	11Vdc, Rout = 220Ω (6V/20mA)
(option) remote Setpoint or Amperometric input	0 ... 10V, 2 ... 10V, Ri ≥ 1MΩ
Feedback input	0 ... 20mA, 4 ... 20mA, Ri = 5Ω
Potentiometer valve position	Potentiometer > 500Ω, TA 50mAac, 50/60Hz, Ri = 1,5Ω, isolation 1500V
CT scale range	configurable from 0, ... , 100.0A
Transmitter power supply (optional)	filtered 10 / 24Vdc, max 30mA short-circuit protection, isolation 1500V
Analogue retransmission signal (opt)	10V / 20mA, isolation 1500V
Logic inputs (optional)	24V NPN, 4.5mA; 24V PNP, 3.6mA isol. 1500V
Serial interface (optional)	CL; RS422/485; RS232; isolation 1500V
Baud rate	1200 ... 19200
Protocol	GEFRAN / MODBUS
Power supply (switching type)	(std) 100 ... 240Vac/dc ±10%; 50/60Hz, 12VA max (opt.) 20...27Vac/dc ±10%; 50/60Hz, 12VA max
Faceplate protection	IP65
Working / Storage temperature range	0...50°C / -20...70°C
Relative humidity	20 ... 85% non-condensing
Environmental conditions of use	for internal use only, altitude up to 2000m
Installation	Panel, plug-in from front
Weight	400g (1600V), 600g (1800V) for the complete version

EMC conformity has been tested with the following connections

FUNCTION	CABLE TYPE	LENGTH
Power supply cable	1 mm ²	1 m
Relay output cable	1 mm ²	3,5 m
Digital communication wires	0,35 mm ²	3,5 m
C.T. connection cable	1,5 mm ²	3,5 m
TC input	0,8 mm ² compensated	5 m
Pt100 input	1 mm ²	3 m

3 · DESCRIPTION OF FACEPLATE

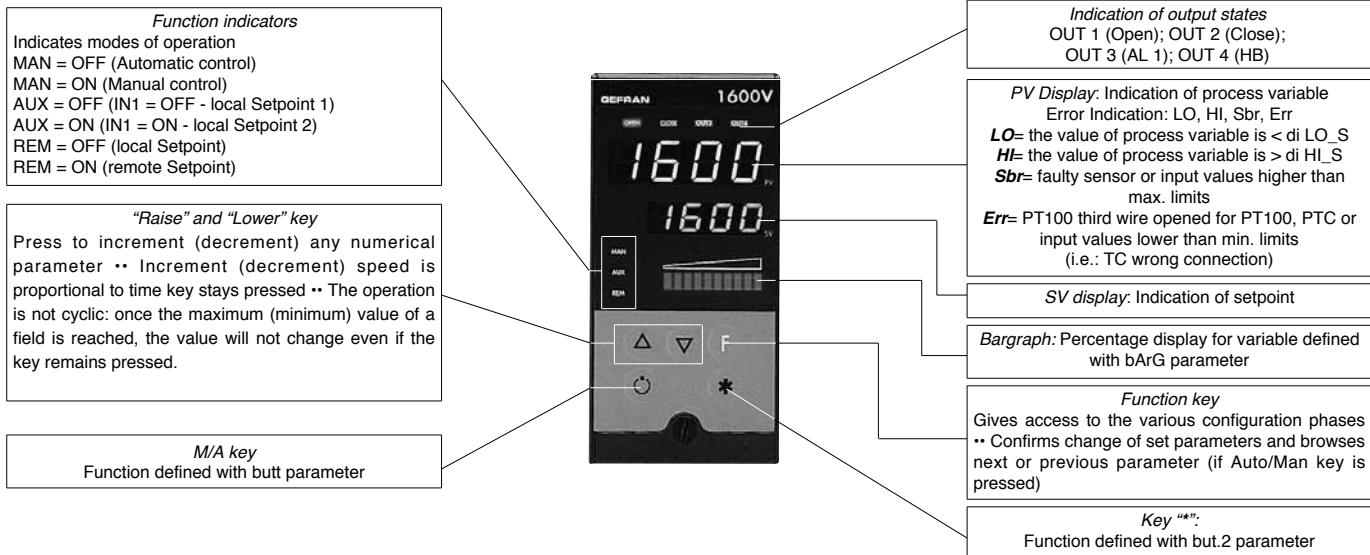

4 · CONNECTIONS

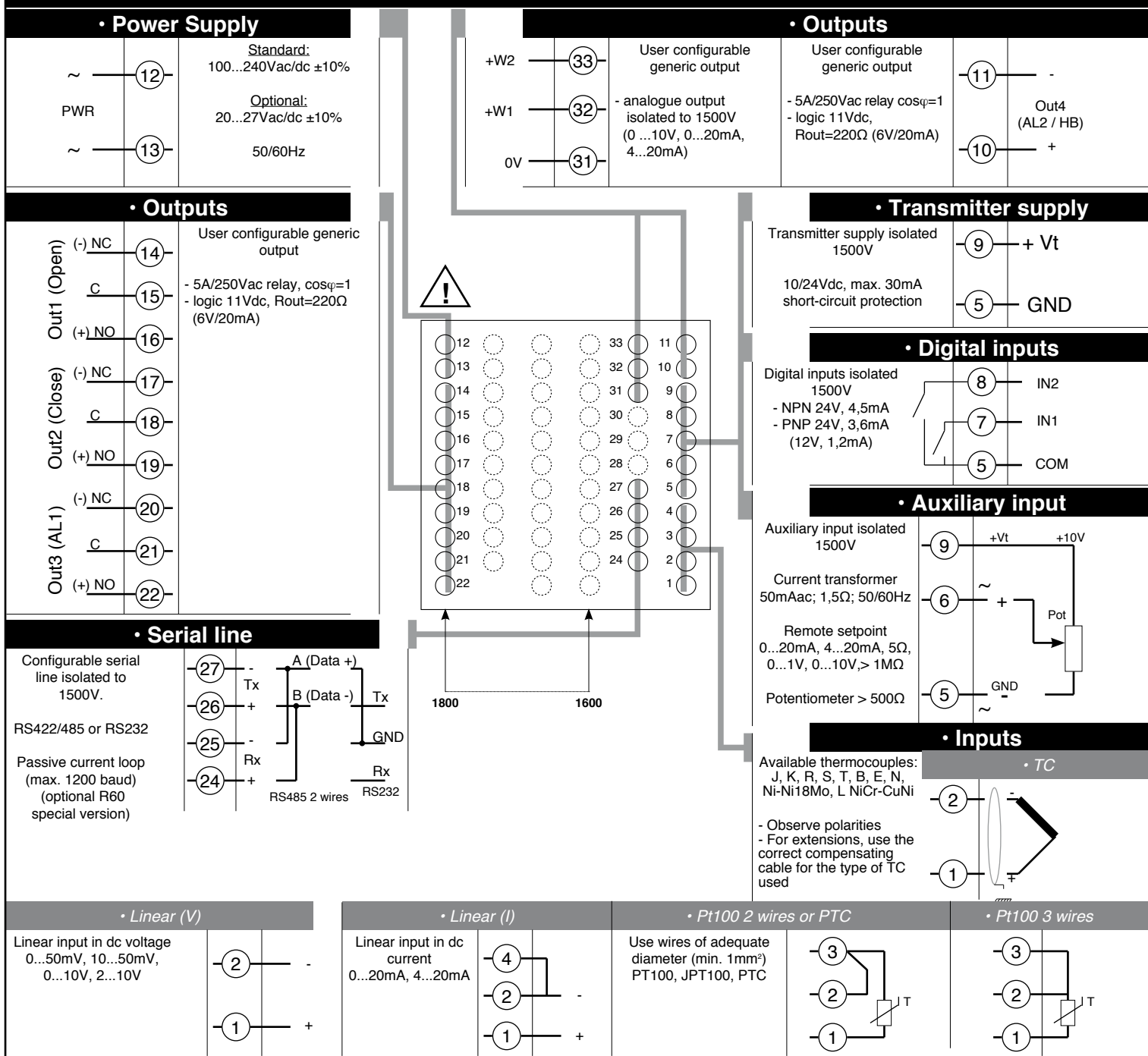

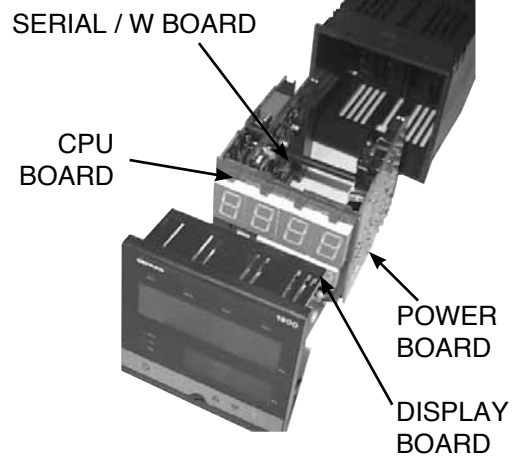
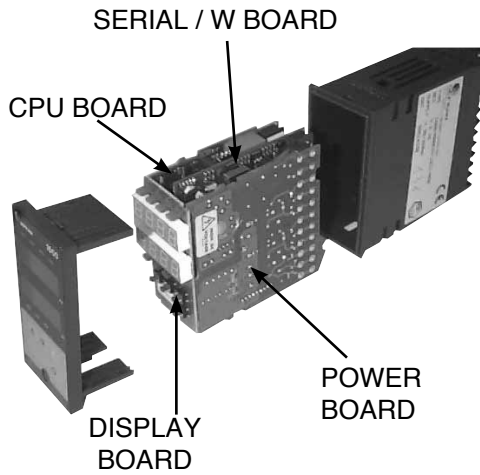

5 · PROGRAMMING and CONFIGURATION

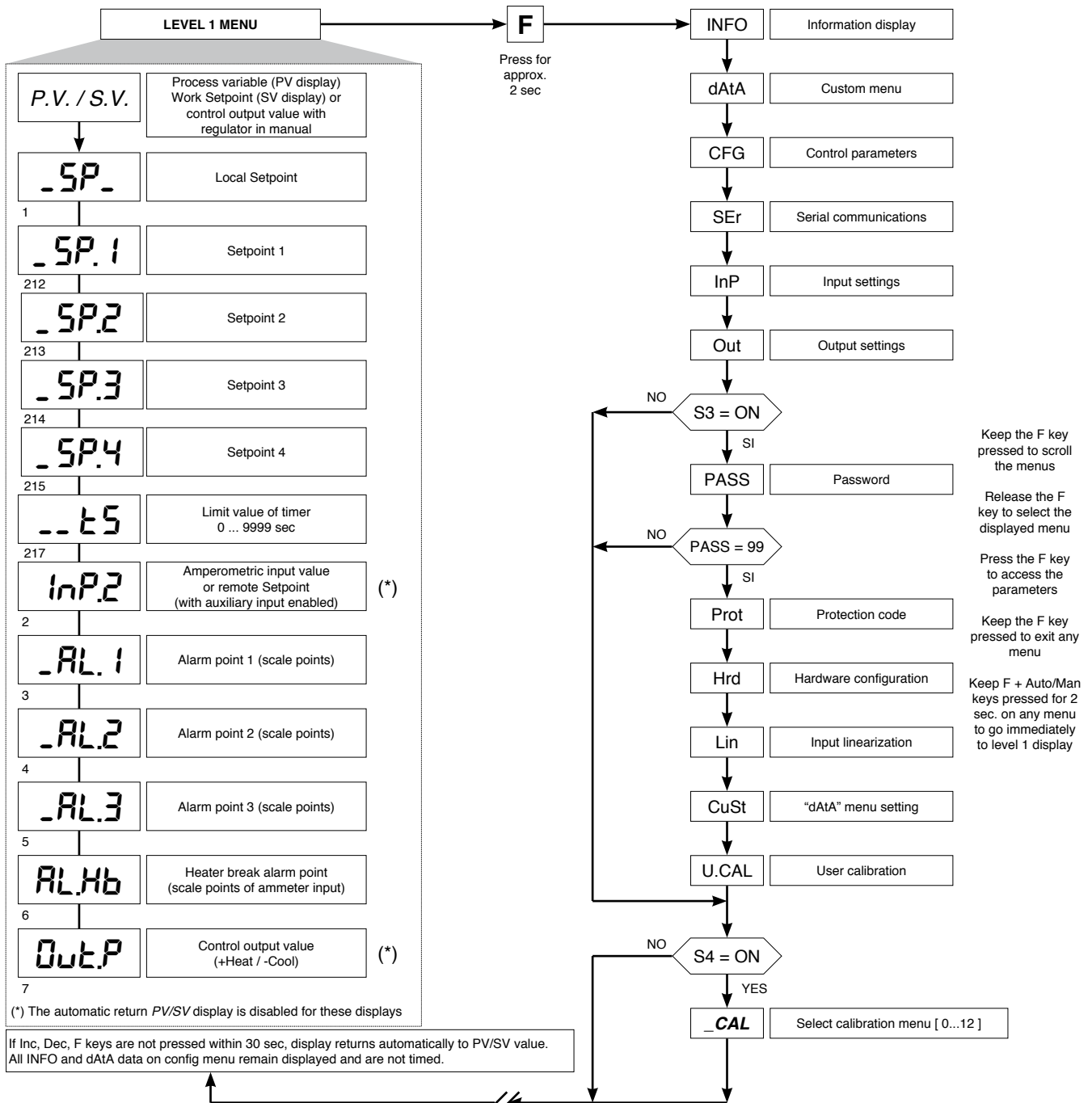

N.B.: Once a particular configuration is entered, all unnecessary parameters are no longer displayed

• InFo Display

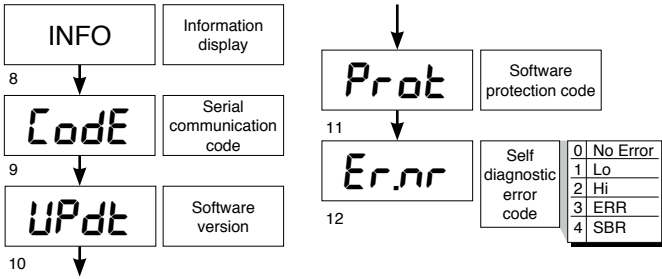

• CFG

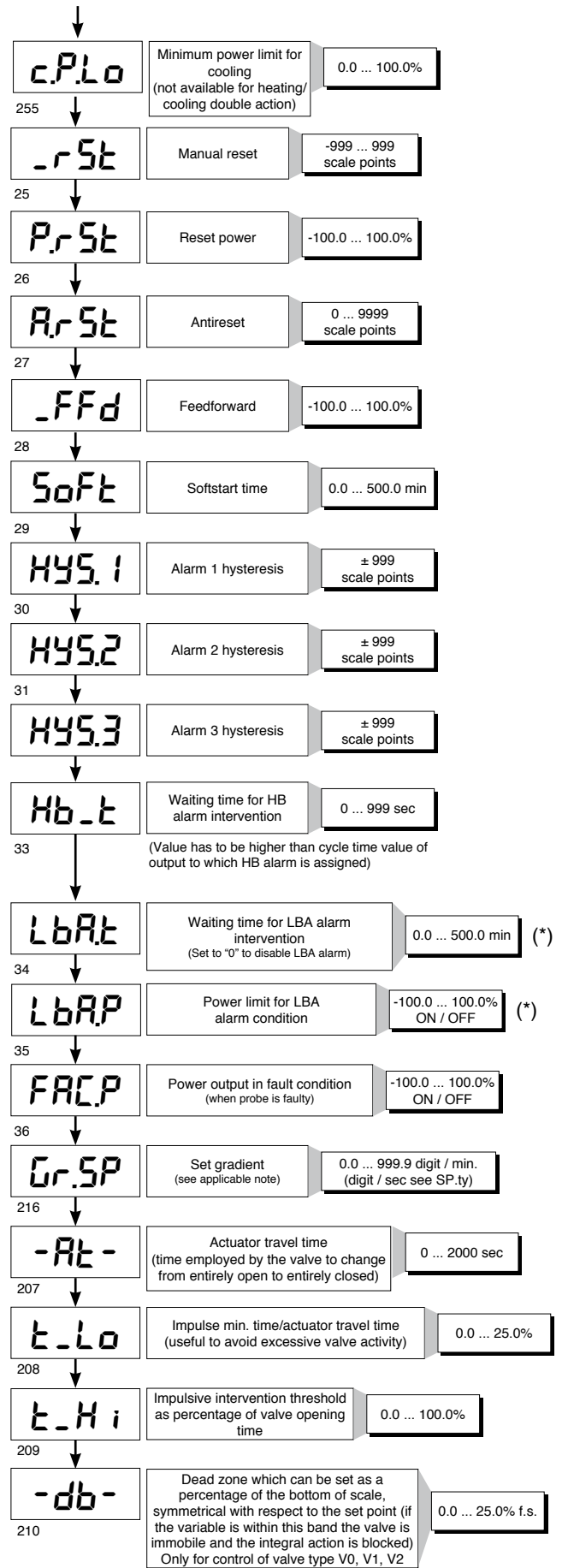
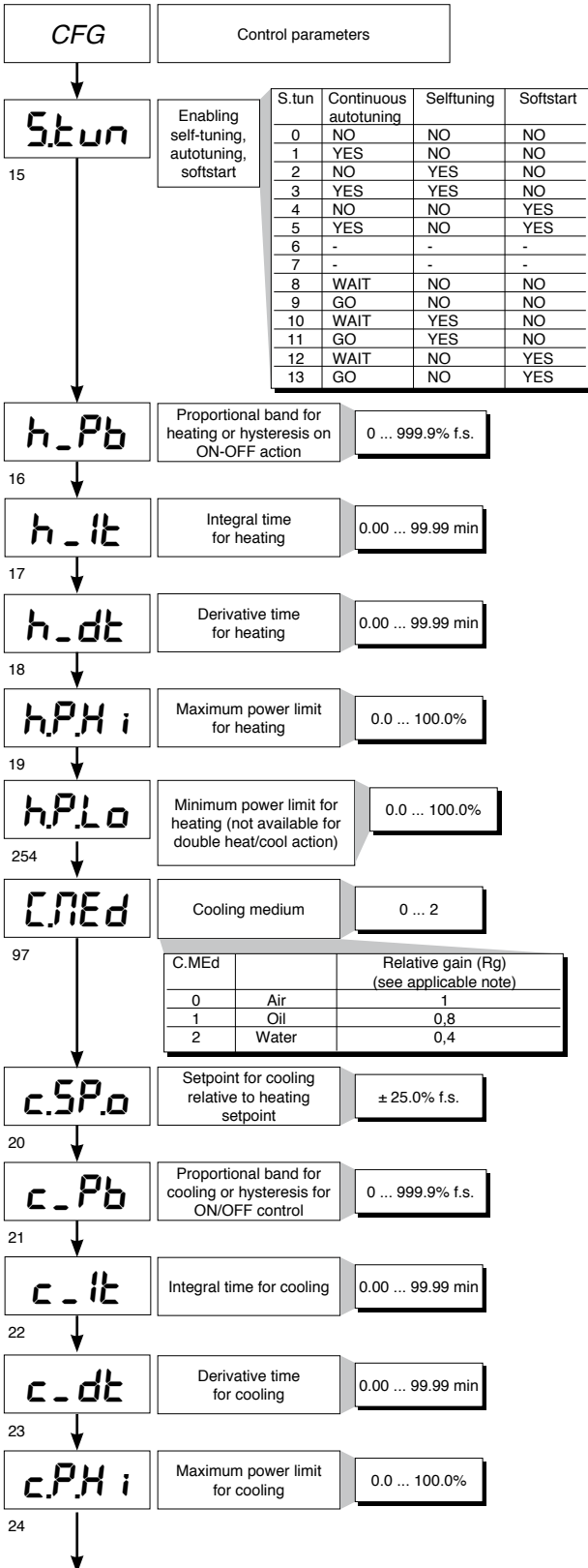

(*) LBA alarm may be reset by simultaneously pressing Δ + ∇ keys when OutP is displayed or by switching to Manual.

Note:
 h_Pb, h_it, h_dt, h.P.Hi, hP.Lo, c_Pb, c_it, c_dt, c.P.Hi, c.P.Lo parameters are "read only" if the option "control parameter groups" has been selected (showing current values)
 c_Pb, c_it, c_dt parameters are "read only" if the option "relative gain heat/cool control" (Ctrl = 14) has been selected.

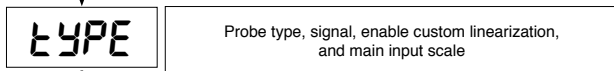
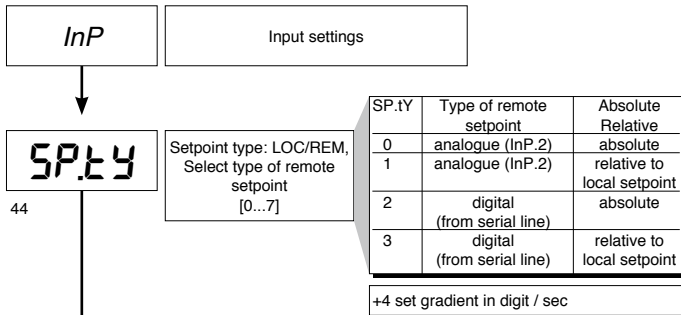
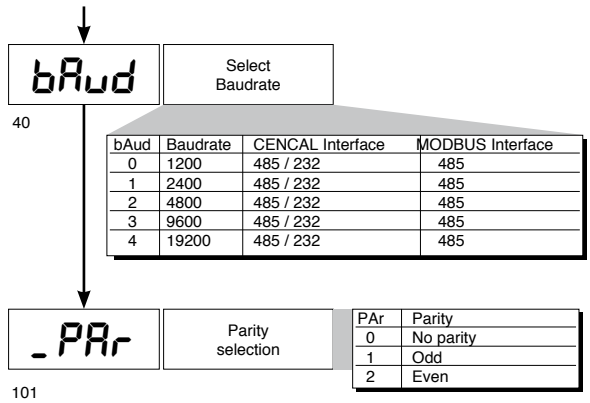
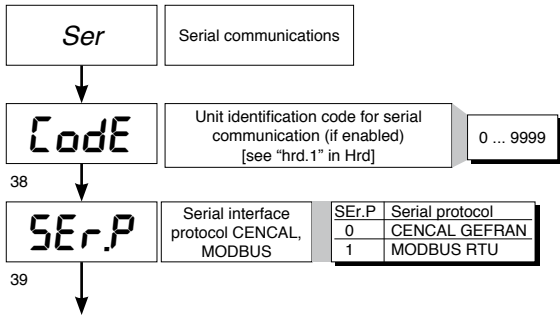

PROBE: TC (SEnS=0)

tYPE	Probe type	Scale (C/F)	Scale range max. without decimal point	Scale range max. with decimal point
0	J (Fe-CuNi)	C	0 / 1000	0.0 / 999.9
1	J (Fe-CuNi)	F	32 / 1832	32.0 / 999.9
2	K (NiCr-Ni)	C	0 / 1300	0.0 / 999.9
3	K (NiCr-Ni)	F	32 / 2372	32.0 / 999.9
4	R (Pt13Rh - Pt)	C	0 / 1750	not available
5	R (Pt13Rh - Pt)	F	32 / 3182	not available
6	S (Pt10Rh - Pt)	C	0 / 1750	not available
7	S (Pt10Rh - Pt)	F	32 / 3182	not available
8	T (Cu-CuNi)	C	-200 / 400	-199.9 / 400.0
9	T (Cu-CuNi)	F	-328 / 752	-199.9 / 752.0
10	B (Pt30Rh - Pt6Rh)	C	44 / 1800	not available
11	B (Pt30Rh - Pt6Rh)	F	111 / 3272	not available
12	E (NiCr-CuNi)	C	-100 / 750	-100.0 / 750.0
13	E (NiCr-CuNi)	F	-148 / 1382	-148.0 / 999.9
14	N (NiCrSi-NiSi)	C	0 / 1300	0.0 / 999.9
15	N (NiCrSi-NiSi)	F	32 / 2372	32.0 / 999.9
16	(Ni - Ni18Mo)	C	0 / 1100	0.0 / 999.9
17	(Ni - Ni18Mo)	F	32 / 2012	32.0 / 999.9
18	L - GOST (NiCr-CuNi)	C	0 / 600	0.0 / 600.0
19	L - GOST (NiCr-CuNi)	F	32 / 1112	32.0 / 999.9
20	TC	C	custom scale	(*)
21	TC	F	custom scale	(*)

PROBE: RTD 3 wires (SEnS=1)

tYPE	Probe type	Scale (C/F)	Scale range max. without decimal point	Scale range max. with decimal point
0	PT100	C	-200 / 850	-199.9 / 850.0
1	PT100	F	-328 / 1562	-199.9 / 999.9
2	JPT100 (JIS C 1609/81)	C	-200 / 600	-199.9 / 600.0
3	JPT100 (JIS C 1609/81)	F	-328 / 1112	-199.9 / 999.9
4	RTD	C	custom scale	(*)
5	RTD	F	custom scale	(*)

PROBE: PTC (SEnS=2) on request, instead of RTD 3 wires

tYPE	Probe type	Scale (C/F)	Scale range max. without decimal point	Scale range max. with decimal point
0	PTC 990Ω	C	-55 ... 120	-55.0 ... 120.0
1	PTC 990Ω	F	-67 ... 248	-67.0 ... 248.0
2	PTC 990Ω	C	custom scale	(*)
3	PTC 990Ω	F	custom scale	(*)

PROBE: VOLTAGE 50mV (SEnS=3)

tYPE	Signal type	Scale	Scale range max.
0	0...50mV	linear	-1999 / 9999
1	0...50mV	custom linear	see table 32 values in Lin
2	10...50mV	linear	-1999 / 9999
3	10...50mV	custom linear	see table 32 values in Lin

PROBE: CURRENT 20mA or TRANSMITTER (SEnS=4)

tYPE	Signal type	Scale	Scale range max.
0	0...20mA	linear	-1999 / 9999
1	0...20mA	custom linear	see table 32 values in Lin
2	4...20mA	linear	-1999 / 9999
3	4...20mA	lineare custom	see table 32 values in Lin

PROBE: VOLTAGE 10V or TRANSMITTER (SEnS=5)

tYPE	Signal type	Scale	Scale range max.
0	0...10V	linear	-1999 / 9999
1	0...10V	custom linear	see table 32 values in Lin
2	2...10V	linear	-1999 / 9999
3	2...10V	custom linear	see table 32 values in Lin

PROBE: CUSTOM 10V (SEnS=6)

tYPE	Signal type	Scale	Scale range max.
0	Custom 0...10V	linear	-1999 / 9999
1	Custom 0...10V	custom linear	see table 32 values in Lin

PROBE: CUSTOM 50mV, 20mA (SEnS=7)

tYPE	Signal type	Scale	Scale range max.
0	Custom	lineare	-1999 / 9999
1	Custom	custom linear	see table 32 values in Lin

(*) Linearization and scale limit settings (with or without decimal point) are selectable from PC via serial line

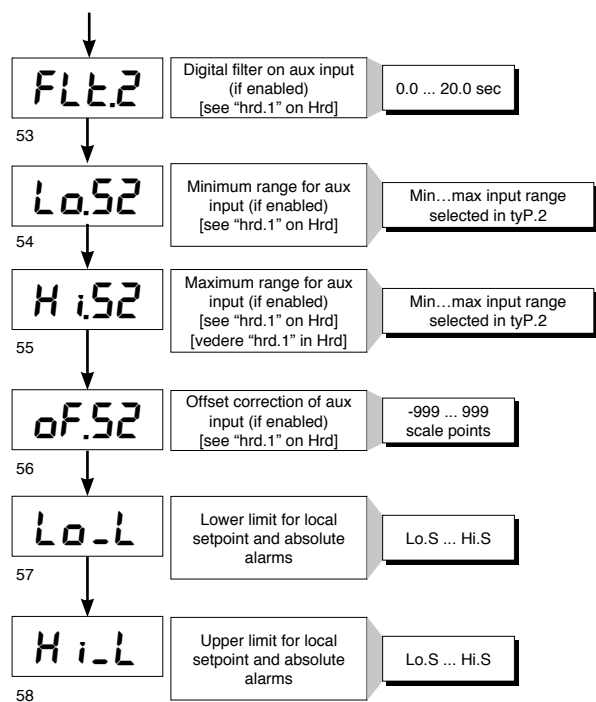
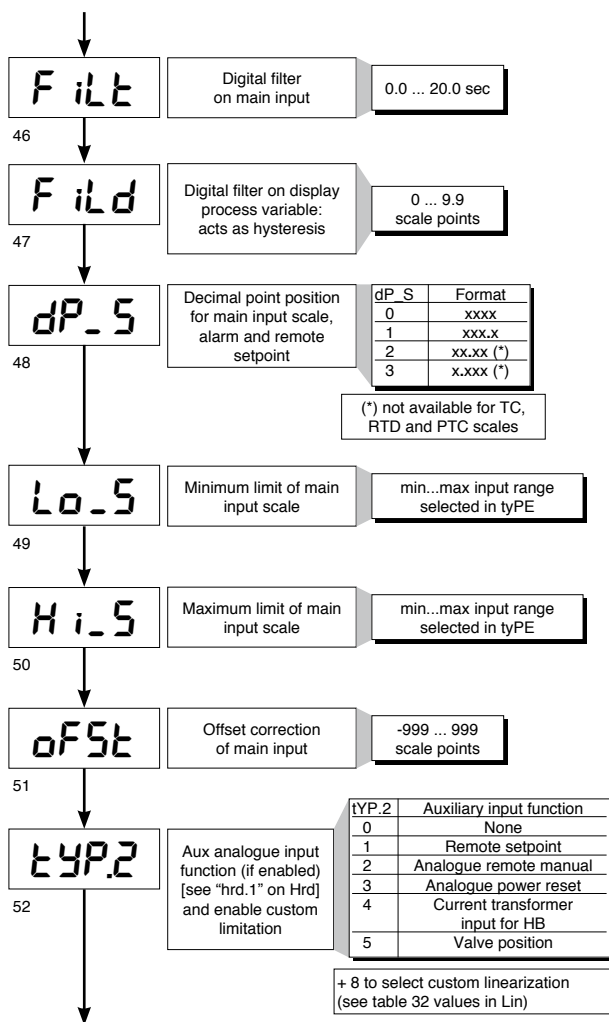

• Out

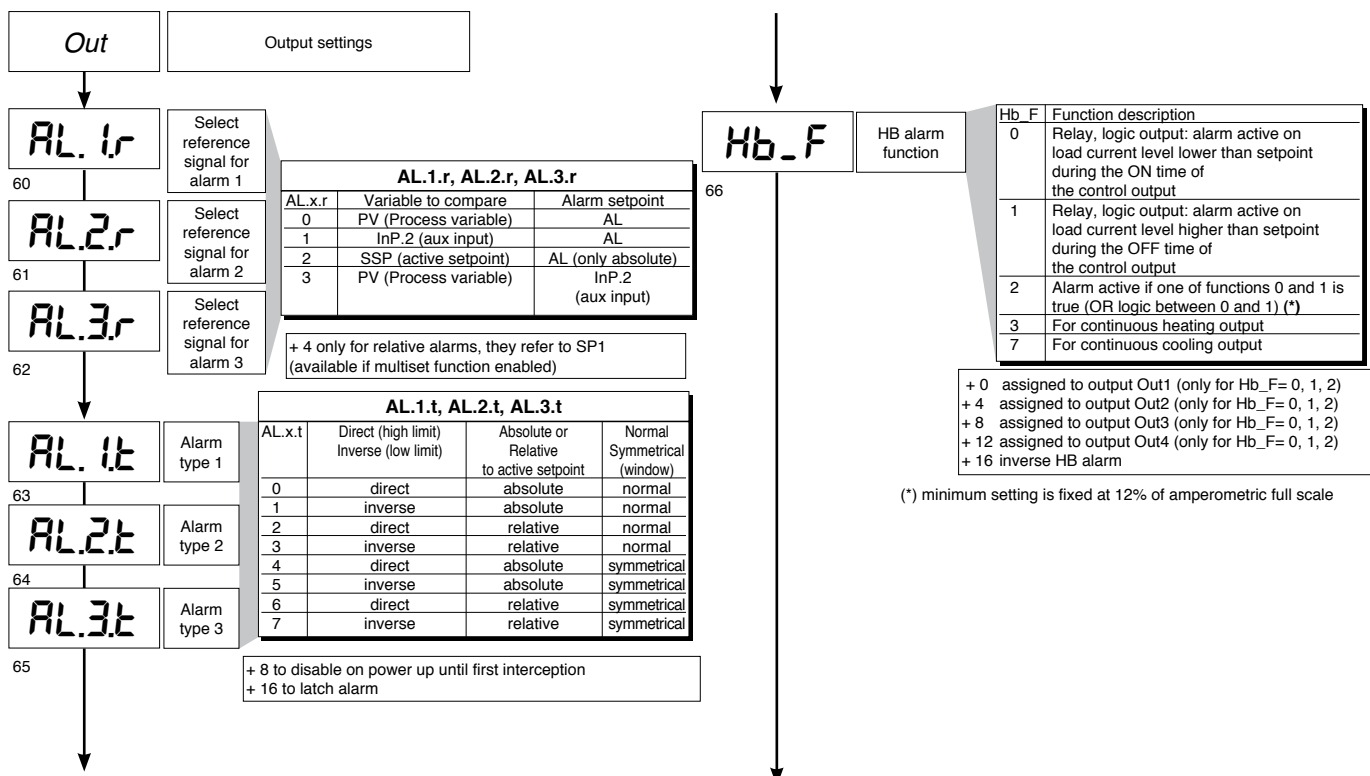

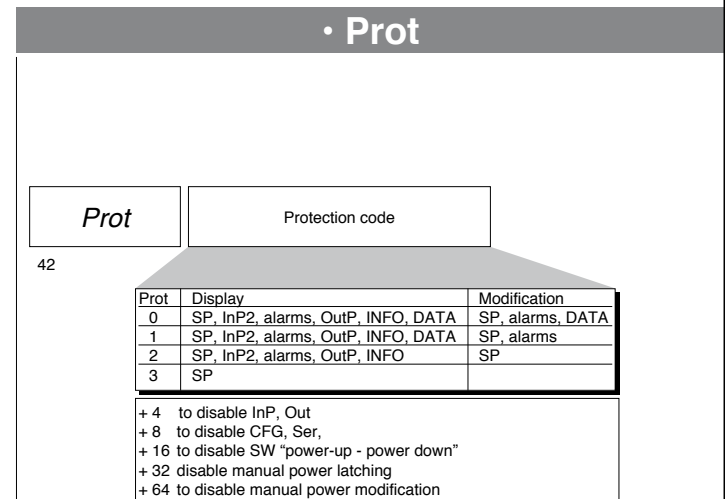
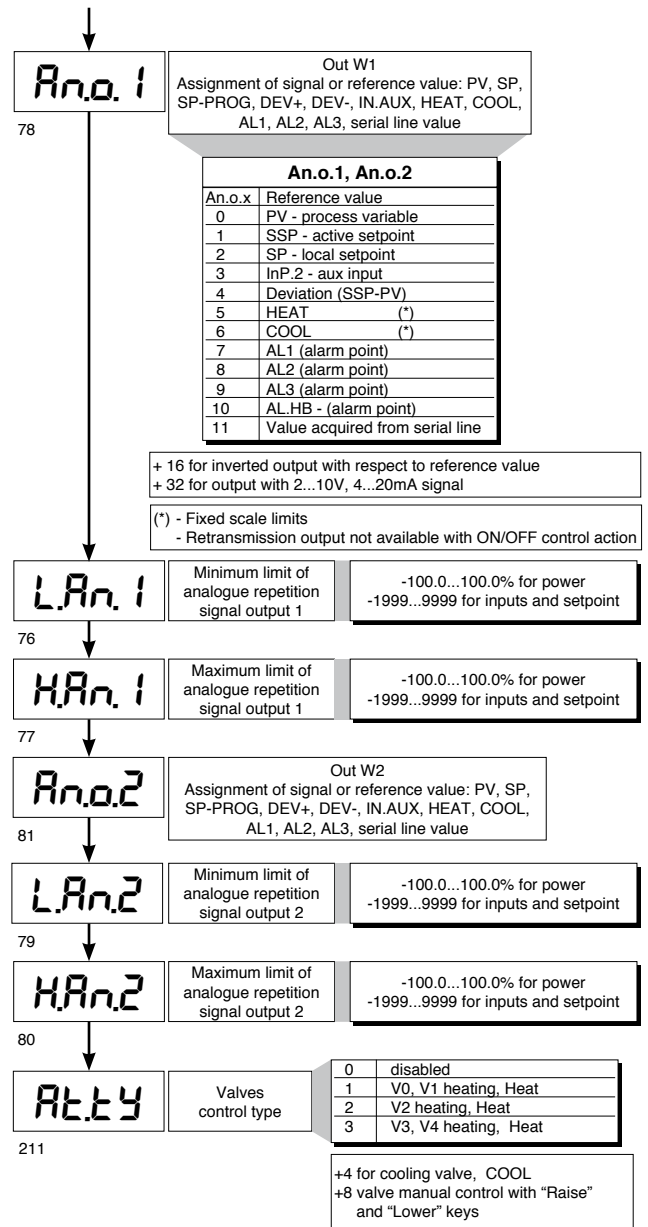
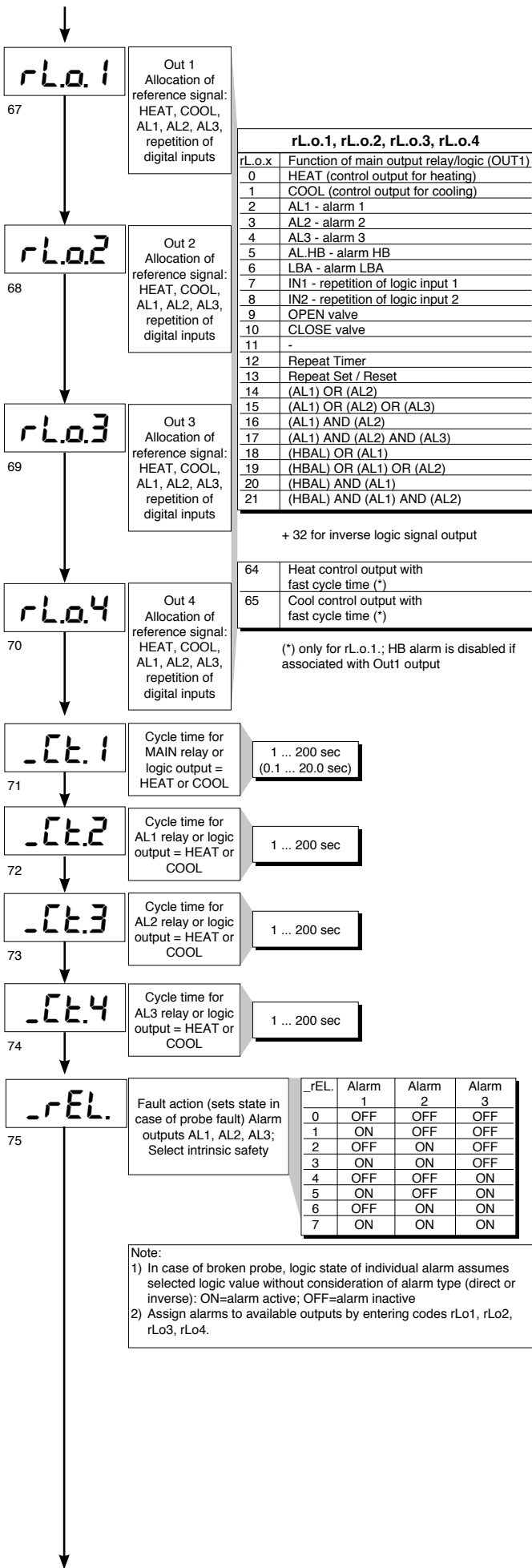

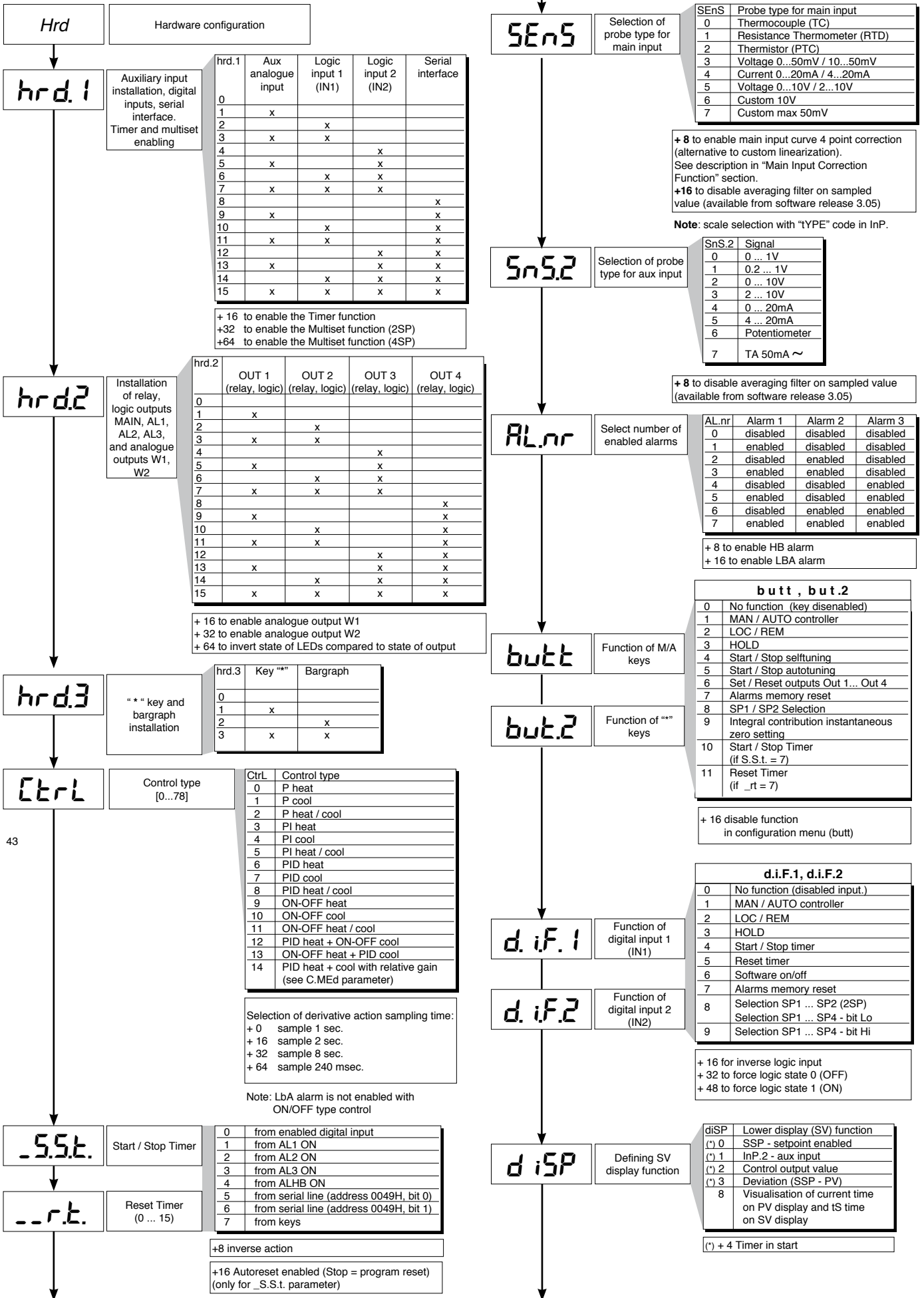

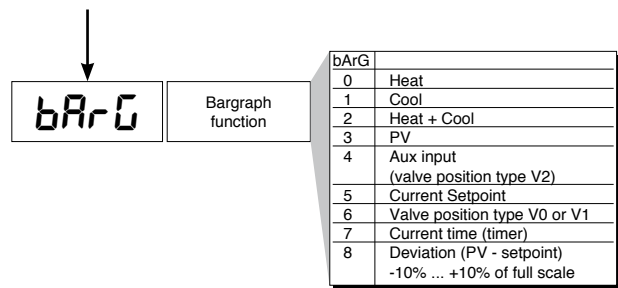
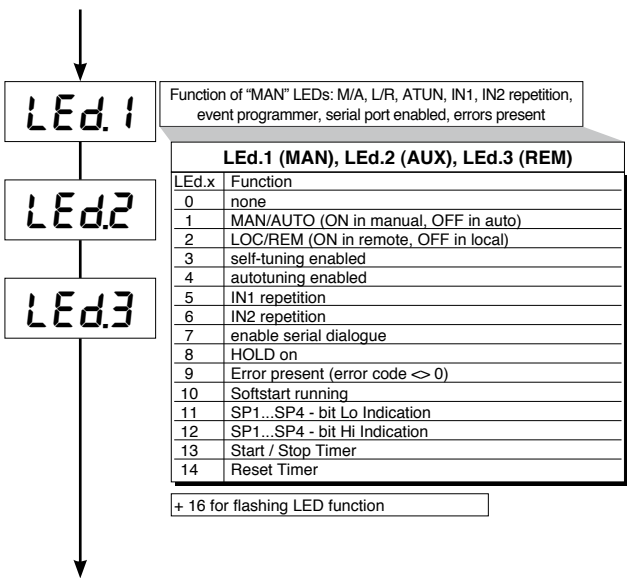

• Lin

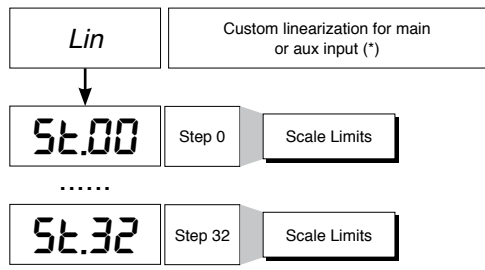

(*) Not available for :
 enabled input correction function (SenS + 8)
 TC custom input type (SenS = 0; tyPE = 20, 21)
 RTD custom input type (SenS = 1; tyPE = 4, 5)
 PTC custom input (SEnS = 2; tyPE= 2, 3)

• CuSt

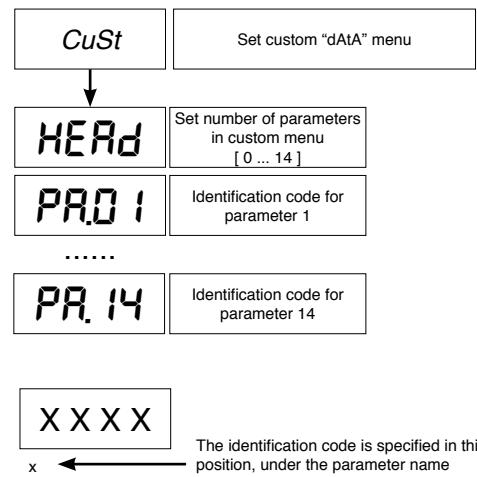

• U.CAL

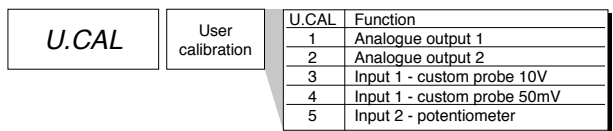

6 • ADJUSTMENT WITH MOTORIZED VALVE

In an adjustment process the adjustment valve has the function of varying fuel delivery (frequently corresponding to the thermal energy introduced into the process) in relation to the signal coming from the controller.

For this purpose it is provided with an actuator able to modify its opening value, overcoming the resistances produced by the fluid passing inside it. The adjustment valves vary the delivery in a modulated manner, producing finite variations in the fluid passage inner area corresponding to finite variations of the actuator input signal, coming from the controller.

The servomechanism, for example, comprises an electric motor, a reducer and a mechanical transmission system which actions the valve. Various auxiliary components can be present such as the mechanical and electrical safety end travels, manual actioning systems, position location.

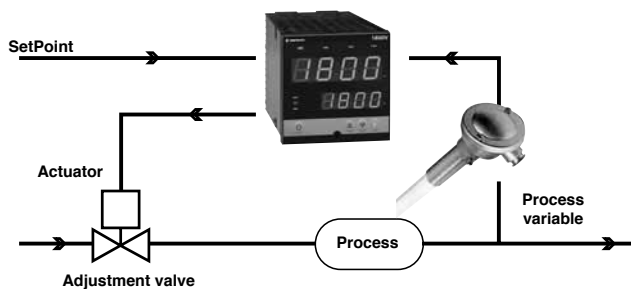

CONTROL EXAMPLE FOR V0 VALVE

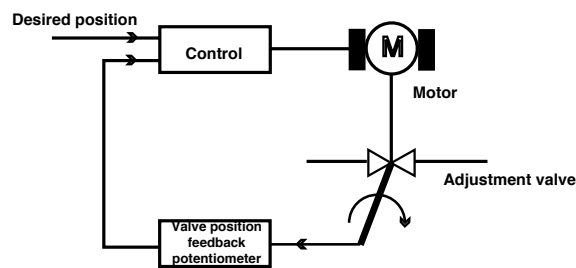

VALVE POSITION CONTROL

The controller determines, on the basis of the dynamics of the process, the control output for the valve corresponding to the opening of the same in such a way so as to maintain the desired value of the process variable.

With counter-reaction valves the position is normally provided by a potentiometer assembled on the actuator.

Characteristic parameters for valves control

- Actuator time (t_{At}) is the time employed by the valve to pass from entirely open to entirely closed (or vice-versa), and can be set with a resolution of one second.

It is a mechanical feature of the valve+actuator unit.

NOTE: if the actuator's travel is mechanically limited it is necessary to proportionally reduce the t_{At} value.

- Minimum impulse (t_{Lo}) expressed as a % of the actuator time (resolution 0.1%).

This represents the minimum variation in position due to which the actuator does not physically respond to the command.

Increasing t_{Lo} reduces wear on the actuator with less precision in the positioning.

- Impulsive intervention threshold (t_{Hi}) expressed as a % of the actuator time (resolution 0.1%) represents the position displacement (requested position – real position) due to which the manoeuvre request becomes impulsive.

The duration of the impulses is proportional to the displacement and greater than or equal to t_{Lo} .

This type of modulated approach allows precise control of the feedback actioned valve, by a potentiometer or not, and is especially useful in cases of high mechanical inertia. Setting $t_{Hi} = 0$ excludes modulation in positioning.

VALVE CONTROL WITH IMPULSIVE MODULATED APPROACH, APPLICABLE ONLY TO FUNCTIONING TYPE V0, V1, V2.

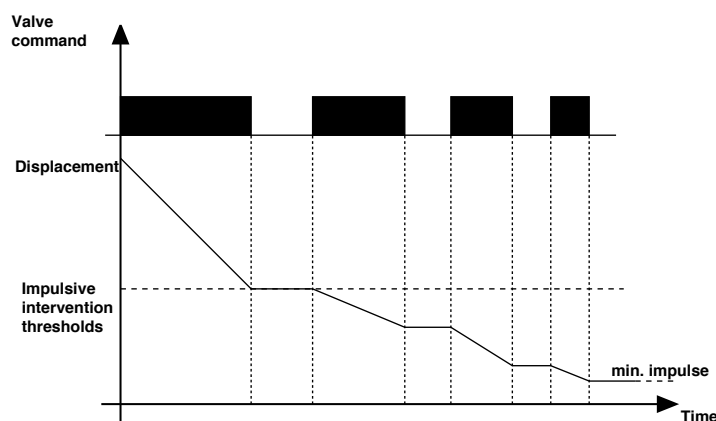

- Zona morta (db) è una banda di scostamento tra il setpoint di regolazione e la variabile di processo entro la quale il regolatore non fornisce nessun comando alla valvola (Apri = OFF; Chiudi = OFF). E' espressa in percentuale del fondo scala ed è simmetrica rispetto al setpoint.

La zona morta è utile a processo assestato per non sollecitare l'attuatore con ripetuti comandi con risultato irrilevante sulla regolazione. Impostando $db = 0$ la zona morta è esclusa.

7 • VALVE CONTROL MODES

With the controller in manual, the setting of parameter $At.ty \geq 8$ allows direct control of the valve open and close commands; the instrument indicates the presumed or real position (for type V2).

V0 - for floating valve without potentiometer;

V1 - for floating valve with potentiometer and display of position;

V2 - for valve with feedback from potentiometer and display of position.

Models V0 and V1 have similar behaviour: every manoeuvre request greater than the minimum impulse is sent to the actuator by means of the OPEN/ CLOSE relays; every action updates the presumed position of the virtual potentiometer calculated on the basis of the actuator travel declared time. In this way there is always a presumed position of the valve which is compared with the position request of the controller. Having reached a presumed extreme position (entirely open or entirely closed determined by the "virtual potentiometer") the controller provides a command in the same direction, in this way ensuring the real extreme position is reached. The actuators are usually protected against the OPEN command in the entirely open position or CLOSE command in the entirely closed position. The V2 model reads the real position of the valve by means of the auxiliary analogue input, expresses the value as a percentage (0.0 – 100.0%) and compares it with the position requested by the controller, then sends the appropriate command to the valve. The auxiliary input of the controller is used to obtain the valve position. Calibration is requested to memorise the extreme position of the potentiometer, minimum and maximum. The potentiometer is usually supplied by the controller itself.

V3 - for floating valve without display of position, PI control

V4 - for floating valve with display of position, PI control; the valve position from the potentiometer is only for viewing on the display and is not used in the adjustment.

When the difference between the position calculated by the controller and the only proportional component exceeds the value corresponding to the minimum impulse the controller provides an OPEN or CLOSE command of the duration of the minimum impulse itself. At each delivery the integral component of the command is set to zero (discharge of the integral). The frequency and duration of the impulses is correlated to the integral time (t_i).

8 • TIMER + 2 SET POINT, TIMER FUNCTION

The timer functionality is enabled in **Hrd** configuration in hrd.1 parameter setting the code +16 or +48 to activate the selection of two set points. In the case of enabling, parameters **_S.S.t.** (start/stop timer) and **_r.t.** (reset timer) define the functioning modality. The intervention threshold of the tS timer can be set at level 1 of programming with bottom of scale 9999 sec. The enabling to the timer, as also the reset condition, can occur due to external contact or alarm conditions (AL1, AL2, AL3, ALHb). The reset function, always active on the status, zero sets the value of the timer and keeps it blocked even if the start is present. In the absence of enabling (stop) the autoreset condition can be active for which the timer zero sets at each stop. It is possible to make the timer visible on the SV display during the active counting phase as specified by the diSP parameter. On reaching the preset time (tS), it is possible to activate a relay of the four available or select set point 2.

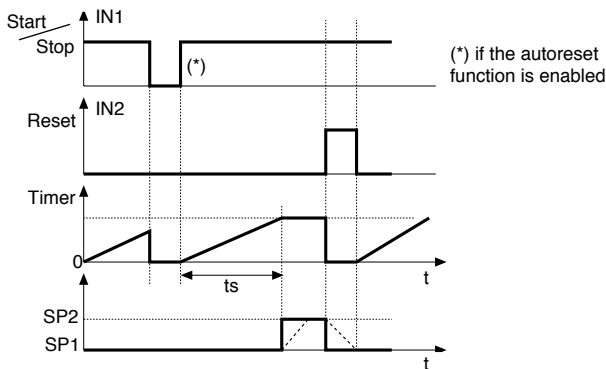

the passage between SP1 and SP2 occurs on the basis of the GrSP value setpoint gradient (0=immediate passage)

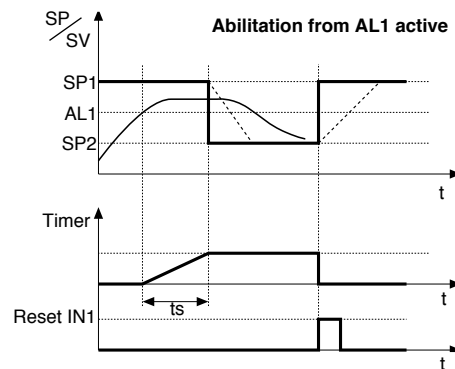

9 • MULTISET FUNCTION, SET GRADIENT

The function is enabled in Hrd configuration in the parameter hrd.1 setting code +64. It allows the setting of n°4 set points which can be selected by means of combinations of digital inputs (IN1, IN2).

The selection between set point 1 and set point 2 can also be carried out by means of front key.

It is possible to visualise the selection between set point 1 / 2 using leds.

SET GRADIENT: if set $\neq 0$, when switching on and during the auto/man passage the set point is assumed to be equal to PV, with gradient set it reaches the local set or that selected.

Every set variation is subject to gradient. The set gradient is inhibited on switching on when the self tuning is enabled.

If the set gradient is set $\neq 0$, this is active even on local setpoint variations, which can be set only in the relative SP menu.

The adjustment setpoint reaches the value set with a speed defined by the gradient.

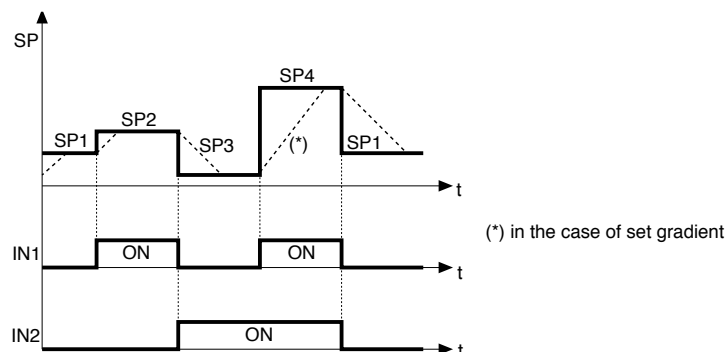

10 • ALARMS

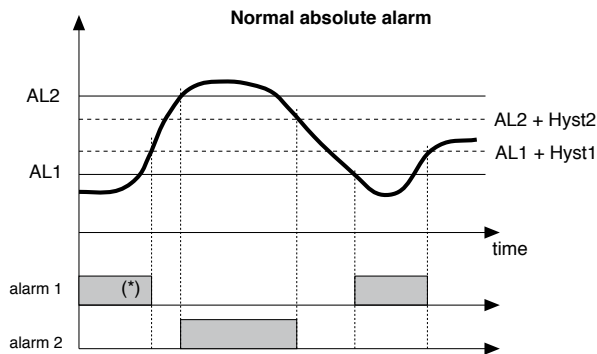

For AL1 = reverse absolute alarm (low) with positive Hyst1, AL1 t = 1
 (*) = OFF if disabled on power-up
 For AL2 = direct absolute alarm (high) with negative Hyst2, AL2 t = 0

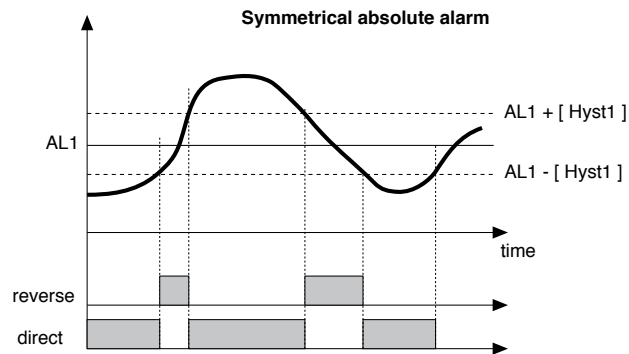

For AL1 = symmetrical Lo absolute alarm with Hyst1, AL1 t = 5
 For AL1 = symmetrical Hi absolute alarm with Hyst1, AL1 t = 4

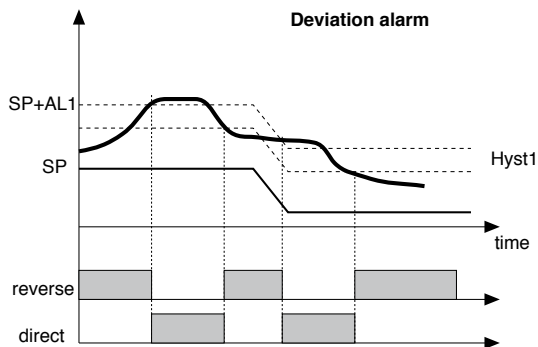

For AL1 = Lo deviation alarm with negative Hyst 1, AL1 t = 3
 For AL1 = Hi deviation alarm with negative Hyst 1, AL1 t = 2

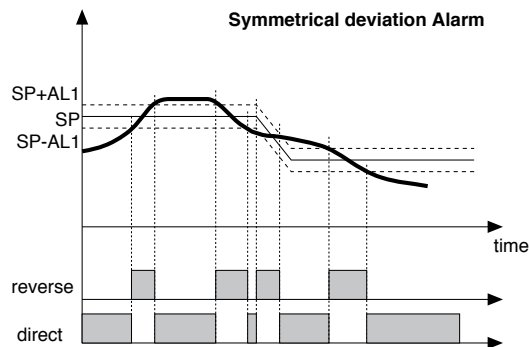

For AL1 = Symmetrical Lo deviation alarm with Hyst 1, AL1 t = 7
 For AL1 = Symmetrical Hi deviation alarm with Hyst 1, AL1 t = 6

HB ALARM

This type of alarm requires use of a current transformer input (CT).

It can indicate variations of load current measured through transformer input in the range (Lo.S2 ... HI.S2).

It is enabled by means of configuration code (Hrd, AL.nr); in this case the alarm setpoint is expressed as HB scale points.

The alarm function and the assigned control output are selected through parameter Hb_F ("Out" phase).

The alarm setpoint is AL.Hb.

The direct HB alarm trips if current transformer input falls below the setpoint for Hb_t seconds of ON time for the selected output.

The HB alarm can be activated only with ON times exceeding 0.4 seconds.

The HB alarm monitors load current even during the OFF period of the cycle time of the selected output.

The HB alarm will trip if measured current exceeds 12% of the CT input full scale for Hb_t seconds when the output is in OFF state.

The alarm is reset automatically when alarm conditions have been cleared.

If AL.Hb is set at = 0, both types of HB alarm are disabled and the assigned relay is de-energized.

The load current reading is displayed by selecting InP2 (level 1).

NOTE: ON/OFF times refer to the cycle time set for the selected output.

Alarm Hb_F = 3 (7), for analog output is ON when the load current is lower than the alarm setpoint; the alarm is disabled if the heating (cooling) output is lower than 2%.

LBA ALARM

This alarm detects an interruption in the control loop caused by a possible short-circuited probe, inverted probe connections or broken load.

If enabled (AL.nr), the alarm trips if the variable does not increase when heating (reduce when cooling) at maximum power for a set time (LbA.t).

The value of the variable is enabled only outside the proportional band; when the alarm is ON, power is limited to value (LbA.P).

The alarm condition resets as soon as temperature increases for heating (or reduces for cooling), or by simultaneously pressing the "▽" and "△" keys in Out.P of level 1.

The LBA function is disabled if LbA.t = 0.

11 • SOFT-START

This function (if enabled) partializes power in proportion to the time elapsed since power-up compared to the preset time 0.0 ... 500.0 min ("SoFt" parameter, CFG). Soft-start is an alternative to self-tuning and is activated each time the unit is powered up. The soft-start function is reset by switching to Manual control.

12 · CONTROL ACTIONS

Proportional Action:

action in which contribution to output is proportional to deviation at input (deviation = difference between controlled variable and setpoint).

Derivative Action:

action in which contribution to output is proportional to rate of variation input deviation.

Integral Action:

action in which contribution to output is proportional to integral of time of input deviation.

Influence of Proportional, Derivative and Integral actions on response of process under control

* An increase in P.B. reduces oscillations but increases deviation.

* A reduction in P.B. reduces the deviation but provokes oscillations of the controlled variable (the system tends to be unstable if P.B. value is too low).

* An increase in Derivative Action corresponds to an increase in Derivative Time, reduces deviation and prevents oscillation up to a critical value of Derivative Time, beyond which deviation increases and prolonged oscillations occur.

* An increase in Integral Action corresponds to a reduction in Integral Time, and tends to eliminate deviation between the controlled variable and the setpoint when the system is running at rated speed.

If the Integral Time value is too long (Weak integral action), deviation between the controlled variable and the setpoint may persist.

Contact GEFTRAN for more information on control actions.

13 · MANUAL TUNING

A) Enter the setpoint at its working value.

B) Set the proportional band at 0.1% (with on-off type setting).

C) Switch to automatic and observe the behavior of the variable. It will be similar to that in the figure:

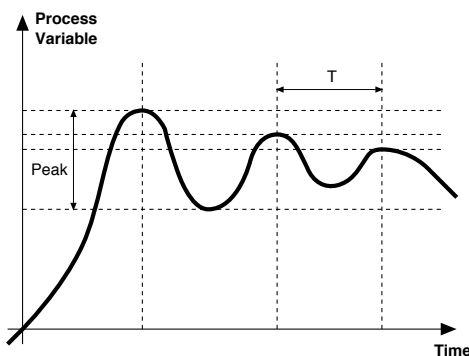

D) The PID parameters are calculated as follows: Proportional band

$$\text{P.B.} = \frac{\text{Peak}}{(\text{V max} - \text{V min})} \times 100$$

(V max - V min) is the scale range.

Integral time: $I_t = 1.5 \times T$

Derivative time: $d_t = I_t/4$

E) Switch the unit to manual, set the calculated parameters. Return to PID action by setting the appropriate relay output cycle time, and switch back to Automatic.

F) If possible, to optimize parameters, change the setpoint and check temporary response. If an oscillation persists, increase the proportional band. If the response is too slow, reduce it.

14 · SOFTWARE ON / OFF SWITCHING FUNCTION

How to switch the unit OFF: hold down the “F” and “Raise” keys simultaneously for 5 seconds to deactivate the unit, which will go to the OFF state while keeping the line supply connected and keeping the process value displayed. The SV display is OFF.

All outputs (alarms and controls) are OFF (logic level 0, relays de-energized) and all unit functions are disabled except the switch-on function and digital communication.

How to switch the unit ON: hold down the “F” key for 5 seconds and the unit will switch OFF to ON. If there is a power failure during the OFF state, the unit will remain in OFF state at the next power-up (ON/OFF state is memorized).

The function is normally enabled, but can be disabled by setting the parameter Prot = Prot +16. This function can be assigned to a digital input (d.i.F.1 or d.i.F.2) and excludes deactivation from the keyboard.

15 • SELF-TUNING

The function works for single output systems (heating or cooling).

The self-tuning action calculates optimum control parameter values during process startup.

The variable (for example, temperature) must be that assumed at zero power (room temperature).

The controller supplies maximum power until an intermediate value between starting value and setpoint is reached, after which it zeros power.

PID parameters are calculated by measuring overshoot and the time needed to reach peak. When calculations are finished, the system disables automatically and the control proceeds until the setpoint is reached.

How to activate self-tuning:

A. Activation at switch-on

1. Switch program to STOP
2. Adjust setpoint to required value
3. Enable self-tuning by setting **Stun** parameter to 2 (CFG menu)
4. Switch unit off
5. Make sure that temperature is approximately room temperature
6. Switch the unit on

B. Activation from keyboard

1. Make sure that M/A key is enabled for Start/Stop self-tuning function (**butt** code = 4 Hrd menu)
2. Switch program to STOP
3. Adjust temperature to approximately room temperature
4. Adjust setpoint to required value
5. Press M/A key to activate self-tuning (Attention: self-tuning will be disabled if the key is pressed again).

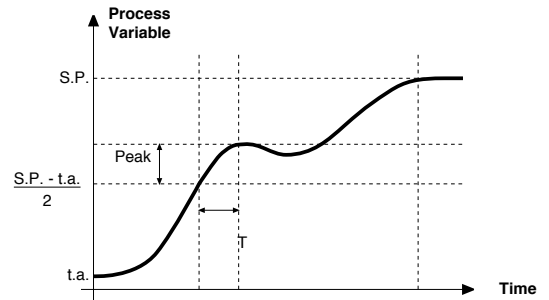

The procedure runs automatically until finished, when the new PID parameters are stored: proportional band, integral and derivative times calculated for the active action (heating or cooling). In case of double action (heating or cooling), parameters for the opposite action are calculated by maintaining the initial ratio between parameters (ex.: $CPb = HPb \cdot K$; where $K = CPb / HPb$ when self-tuning starts). When finished, the **Stun** code is automatically cancelled.

Notes:

- The procedure interrupts when the setpoint value is exceeded. In this case, the **Stun** code is not cancelled.
- It is good practice to enable one of the configurable LEDs to signal self-tuning status. By setting one of LED1, LED2, LED3 = 3 (or 19) on the Hrd menu, the corresponding LED will be on (or flashing) when self-tuning is active.
- For the programmer model, the program is in STOP if self-tuning is activated when the unit is switched on.

16 • AUTO-TUNING

PID parameters cannot be set if the self-tuning function is enabled.

The function can be one of two types: permanent or one-shot.

The first continuously measures system oscillations to find the optimum PID values to reduce such oscillations.

It does not engage if the oscillations drop below 1.0% of the proportional band.

It is interrupted if the setpoint is changed, and is automatically resumed when the setpoint stabilizes.

The calculated parameters are not stored.

If the unit is switched off, the controller reverts to the values set before self-tuning was enabled.

One-shot self-tuning is useful for calculating values around a setpoint. It produces a variation of 10% of current power at the output and examines the effect of the overshoot over time. These parameters are stored and replace those previously set. After this disturbance, the controller resumes control at the setpoint using the new parameters. The parameter activated in CFG is accepted only if the control power is between 20 and 80%.

17 • CONTROL OUTPUT

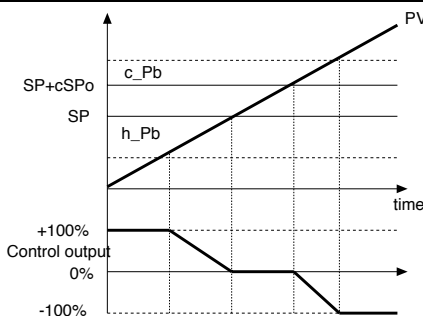

Control output with proportional action only if proportional heating band is separated from proportional cooling band.

PV = Process Value
 SP+cSPo = Cooling Setpoint
 c_Pb = Proportional cooling band

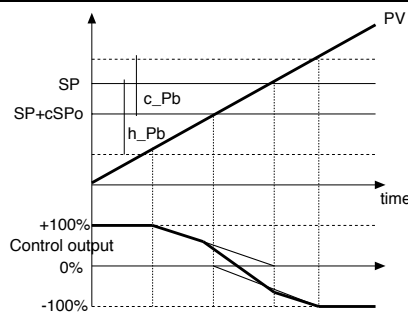

Control output with proportional action only if proportional heating band overlaps proportional cooling band.

SP = Heating Setpoint
 h_Pb = Proportional heating band

Heating/Cooling control with relative gain

In this control mode (enabled with **Ctrl** = 14 parameter) the type of cooling has to be specified.

Cooling PID parameters are therefore calculated based on heating parameters according to the specified ratio.

(for example: $c_MEd = 1$ (oil), $H_Pb = 10$, $H_dt = 1$, $H_It = 4$ implies: $C_Pb = 12,5$, $C_dt = 1$, $C_It = 4$)

We advise you to apply the following values when setting output cycle times:

Air T Cool Cycle = 10 sec.

Oil T Cool Cycle = 4 sec.

Water T Cool Cycle = 2 sec.

NB.: Cooling parameters **cannot be modified** in this mode.

18 • MAIN INPUT CORRECTION FUNCTION

Lets you custom correct reading of the main input by setting four values: A1, B1, A2, B2.

This function is enabled by setting "Sens" +8 code ("Hrd" menu).

Example: Sens = 1+8 = 9 for RTD probe with input correction.

The scale can be reversed if this function is applied to linear scales (50mv, 10V, 20mA, Pot).

The four values are set on the "Lin" menu as follows: A1 = St100, B1 = St01, A2 = St02, B2 = St03. Setting is limited to the defined scale ("LoS" ... "HiS" on "InP" menu). The offset function ("oFt" parameter on "InP" menu) remains enabled.

Limits:

B1 always greater than A1;

B1-A1 at least 25% of full scale of selected probe.

Example:

Sens = 9, TyPE = 0 (Pt100 natural scale -200...+600), dPS = 0

LoS = 0, HiS = 400, oFt = 0

Reference point on real curve:

A1 = St00 = 50, B1 = St01 = 350 (B1-A1 = 300, greater than 25% of 800)

Corresponding points on corrected curve: A2 = St02 = 120, B2 = St03 = 220

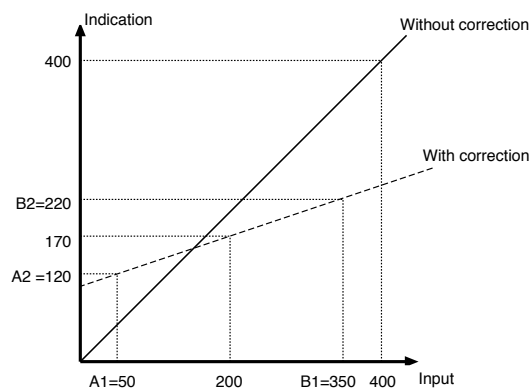

19 • ACCESSORIES

• CURRENT TRANSFORMER

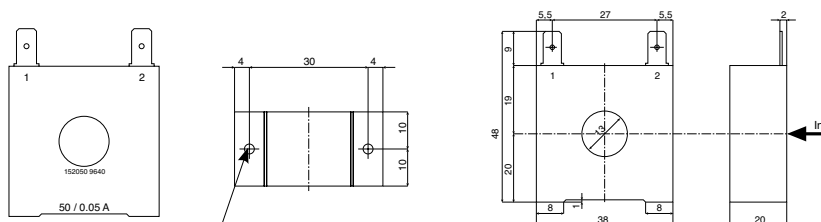

Hole for 2.9 x 9 self-threading screws

These transformers are used to measure currents of 50 ÷ 60Hz from 25A to 600A (nominal primary current).

The peculiar characteristic of these transformers is the high number of secondary turns.

This provides a very low secondary current, suitable for an electronic measurement circuit. The secondary current may be detected as voltage on a resistor.

CODICE CODE	Ip / Is	Ø Secondary Wire	n	USCITE OUTPUTS	Ru	Vu	PRECISIONE ACCURACY
TA/152 025	25 / 0.05A	0.16 mm	n _{1:2} = 500	1 - 2	40 Ω	2 Vac	2.0 %
TA/152 050	50 / 0.05A	0.18 mm	n _{1:2} = 1000	1 - 2	80 Ω	4 Vac	1.0 %

• ORDER CODE

COD. 330200	IN = 50Aac OUT = 50mAac
COD. 330201	IN = 25Aac OUT = 50mAac

• Interface for GEFRA instrument configuration

KIT PC USB / RS485 o TTL



Kit for PC via the USB port (Windows environment) for GEFRA instruments configuration:

Lets you read or write all of the parameters

- A single software for all models
- Easy and rapid configuration
- Saving and management of parameter recipes
- On-line trend and saving of historical data

Component Kit:

- Connection cable PC USB ... port TTL
- Connection cable PC USB ... RS485 port
- Serial line converter
- CD SW GF Express installation

• ORDERING CODE

GF_eXK-2-0-0	cod F049095
--------------	-------------

ORDER CODE

MODEL	
1600V	1600V
1800V	1800V

OUTPUTS 1,2,3,4 (R/D)	
Out1 (D) + Out2 (R) + Out3 (R)	DRR0
Out1 (D) + Out2 (R) + Out3 (R) + Out4 (R)	DRRR
Out1 (D) + Out2 (R) + Out3 (R) + Out4 (D)	DRRD
Out1 (R) + Out2 (R) + Out3 (R)	RRR0
Out1 (R) + Out2 (R) + Out3 (R) + Out4 (R)	RRRR
Out1 (R) + Out2 (R) + Out3 (R) + Out4 (D)	RRRD

OUTPUTS 5, 6	
None	00
OUT 5 (W1) 0...10V	V0
OUT 5 (W1) 0/4...20mA	I0
OUT 5 (W1) 0...10V OUT 6 (W2) 0...10V	VV
OUT 5 (W1) 0/4...20mA OUT 6 (W2) 0...10V	IV
OUT 5 (W1) 0/4...20mA OUT 6 (W2) 0/4...20mA	II

POWER SUPPLY	
0	20...27Vac/dc
1	100...240Vac/dc

DIGITAL COMMUNICATIONS	
0	None
2	RS 485 / RS 232

AUXILIARY INPUTS INSPR/INTA DIGITAL INPUTS IN1, IN2 TRANSMITTER SUPPLY	
00	None
01	IN1, IN2 NPN/PNP
03	Trasmitter Supply 10 V/24V
04	IN1, IN2 NPN/PNP + Trasmitter Supply 10 V/24V
06	IN SPR (0...1V) + Trasmitter Supply 10 V/24V
07	IN SPR (0...10V) / IN Potentiometer # + Trasmitter Supply 10 V/24V
08	IN SPR (0/4...20mA) + Trasmitter Supply 10 V/24V
09	IN TA (5050mAac) + Trasmitter Supply 10 V/24V
10	IN1, IN2 NPN/PNP IN SPR (0...10V) + Trasmitter Supply 10V/24V
11	IN1, IN2 NPN/PNP IN SPR (0...10V) / IN Potentiometer # + Trasmitter Supply 10 V/24V
12	IN1, IN2 NPN/PNP IN SPR (0/4...20mA) + Trasmitter Supply 10 V/24V
13	IN1, IN2 NPN/PNP IN TA (50mAc.a.) + Trasmitter Supply 10V/24V
33	IN SPR (0...1V)
34	IN SPR (0...10V) / Potentiometer #
35	IN SPR (0/4...20mA)
36	IN TA (50mAac)

Potentiometer input requires 10V supply transmitter

Make specific calibration request for PTC input.

Kindly contact GEFRA for information on available codes.

• WARNINGS



WARNING: this symbol indicates danger.

It is placed near the power supply circuit and near high-voltage relay contacts.

Read the following warnings before installing, connecting or using the device:

- follow instructions precisely when connecting the device.
- always use cables that are suitable for the voltage and current levels indicated in the technical specifications.
- the device has no ON/OFF switch: it switches on immediately when power is turned on. For safety reasons, devices permanently connected to the power supply require a two-phase disconnecting switch with proper marking. Such switch must be located near the device and must be easily reachable by the user. A single switch can control several units.
- if the device is connected to electrically NON-ISOLATED equipment (e.g. thermocouples), a grounding wire must be applied to assure that this connection is not made directly through the machine structure.
- if the device is used in applications where there is risk of injury to persons and/or damage to machines or materials, it MUST be used with auxiliary alarm units. You should be able to check the correct operation of such units during normal operation of the device.
- before using the device, the user must check that all device parameters are correctly set in order to avoid injury to persons and/or damage to property.
- the device must NOT be used in inflammable or explosive environments. It may be connected to units operating in such environments only by means of suitable interfaces in conformity to local safety regulations.
- the device contains components that are sensitive to static electrical discharges. Therefore, take appropriate precautions when handling electronic circuit boards in order to prevent permanent damage to these components.

Installation: installation category II, pollution level 2, double isolation

The equipment is intended for permanent indoor installations within their own enclosure or panel mounted enclosing the rear housing and exposed terminals on the back

- power supply lines must be separated from device input and output lines; always check that the supply voltage matches the voltage indicated on the device label.
- install the instrumentation separately from the relays and power switching devices
- do not install high-power remote switches, contactors, relays, thyristor power units (particularly if "phase angle" type), motors, etc... in the same cabinet.
- avoid dust, humidity, corrosive gases and heat sources.
- do not close the ventilation holes; working temperature must be in the range of 0...50°C.

If the device has faston terminals, they must be protected and isolated; if the device has screw terminals, wires should be attached at least in pairs.

• **Power:** supplied from a disconnecting switch with fuse for the device section; path of wires from switch to devices should be as straight as possible; the same supply should not be used to power relays, contactors, solenoid valves, etc.; if the voltage waveform is strongly distorted by thyristor switching units or by electric motors, it is recommended that an isolation transformer be used only for the devices, connecting the screen to ground; it is important for the electrical system to have a good ground connection; voltage between neutral and ground must not exceed 1V and resistance must be less than 60Ω; if the supply voltage is highly variable, use a voltage stabilizer for the device; use line filters in the vicinity of high frequency generators or arc welders; power supply lines must be separated from device input and output lines; always check that the supply voltage matches the voltage indicated on the device label.

• **Input and output connections:** external connected circuits must have double insulation; to connect analog inputs (TC, RTD) you have to: physically separate input wiring from power supply wiring, from output wiring, and from power connections; use twisted and screened cables, with screen connected to ground at only one point; to connect adjustment and alarm outputs (contactors, solenoid valves, motors, fans, etc.), install RC groups (resistor and capacitor in series) in parallel with inductive loads that work in AC (*Note: all capacitors must conform to VDE standards (class x2) and support at least 220 VAC. Resistors must be at least 2W*); fit a 1N4007 diode in parallel with the coil of inductive loads that operate in DC.

GEFRAN spa will not be held liable for any injury to persons and/or damage to property deriving from tampering, from any incorrect or erroneous use, or from any use not conforming to the device specifications.

**PONTICELLI PER CONFIGURAZIONE
JUMPERS FOR CONFIGURATION
BRÜCKEN FÜR KONFIGURATION**

**PONTS ÉTAÏN POUR CONFIGURATION
PUENTES PARA CONFIGURACIÓN
PONTES PARA CONFIGURAÇÃO**

SCHEDA POWER 90/260 (44995)4 e POWER 10/30 (45115)1
 POWER BOARD 90/260 (44995)4 and POWER 10/30 (45115)1
 NETZTEIL-KARTE 90/260 (44995)4 und POWER 10/30 (45115)1
 CARTE ALIMENTATION 90/260 (44995)4 et POWER 10/30 (45115)1
 FICHA ALIMENTACIÓN 90/260 (44995)4 y POWER 10/30 (45115)1
 PLACA DE ALIMENTAÇÃO 90/260 (44995)4 e POWER 10/30 (45115)1

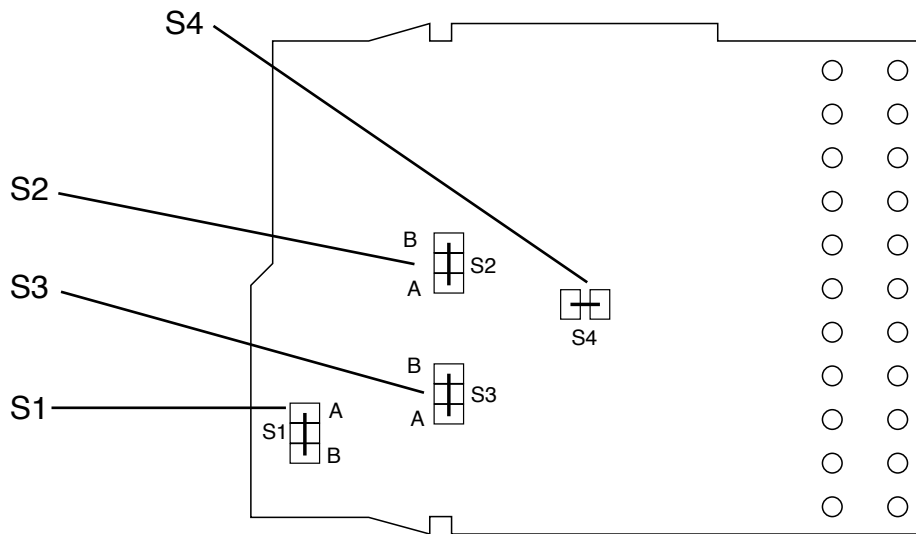

Fig. 1

TIPO USCITA OUTPUT TYPE AUSGANGSTYP TYPE SORTIE TIPO DE SALIDA TIPO DE SAÍDA	S2	S3
Relè diseccitato power ON Relay OFF at power ON Relais angezogen = Kontakt geöffnet Relais désexcité mise en marche Relé desexcitado con "power ON" Relé não excitado com alimentação ON	(posizione A) (position A) (Stellung A) (position A) (posición A) (posição A)	(posizione A) (position A) (Stellung A) (position A) (posición A) (posição A)
Relè eccitato power ON Relay ON at power ON Relais angezogen = Kontakt geschlossen Relais excité mise en marche Relé excitado con "power ON" Relé excitado com alimentação ON	(posizione B) (position B) (Stellung B) (position B) (posición B) (posição B)	(posizione B) (position B) (Stellung B) (position B) (posición B) (posição B)

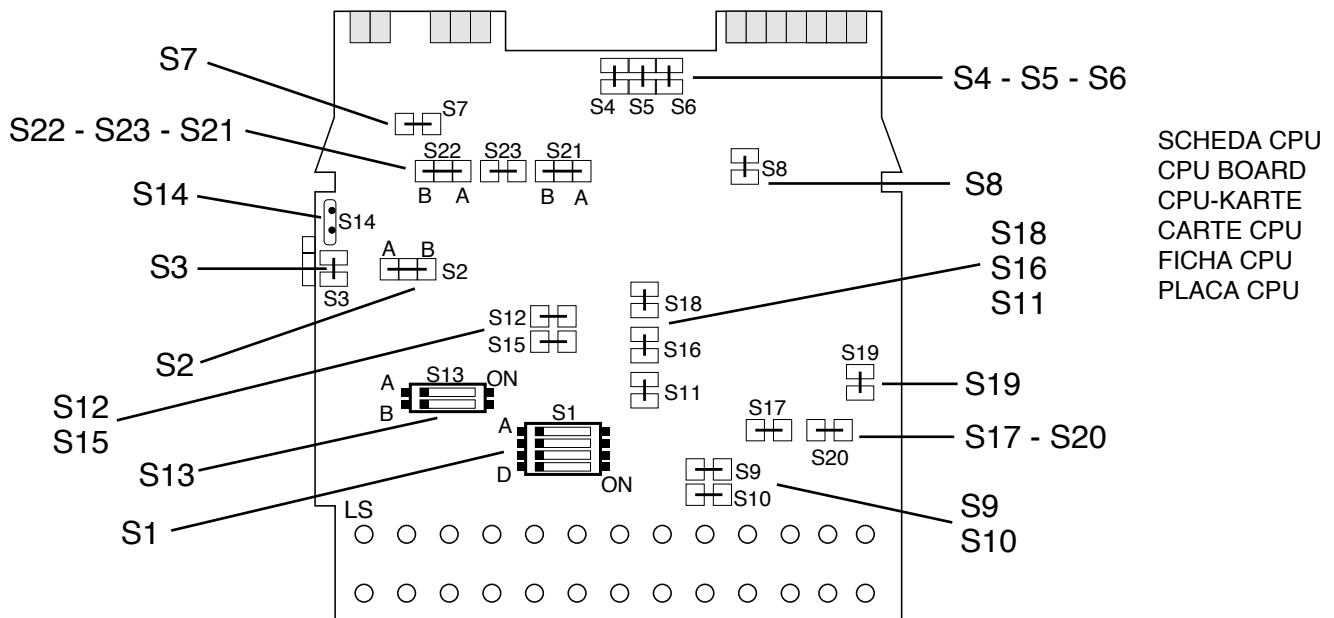

Fig. 2

DESCRIZIONE DESCRIPTION BESCHREIBUNG	PONTICELLI JUMPERS BRÜCKEN
Abilitazione configurazione (stagno) Enable configuration (Tin) Freigabe der Konfiguration (Lötzinn)	S3 (chiuso) S3 (closed) S3 (geschlossen)
Abilitazione configurazione (jumper) Enable configuration (jumper) Freigabe der Konfiguration (jumper)	S14 (chiuso) * S14 (closed) * S14 (geschlossen) *
Abilitazione calibrazione Enable calibration Freigabe der Kalibration	S4 (chiuso) S4 (closed) S4 (geschlossen)
Non utilizzato Not used Nicht verwendet	S7 S7 S7
Abilitazione sonda PTC Enable PTC probe Freigabe Fühler PTC	S17 (aperto) S17 (open) S17 (geöffnet)
Abilitazione sonda PT100 (standard) Enable PT100 probe (standard) Freigabe Fühler PT100 (standard)	S17 (chiuso) S17 (closed) S17 (geschlossen)
HB.F = 0, 1, 2 HB.F = 0, 1, 2 HB.F = 0, 1, 2	S18 (chiuso) S18 (closed) S18 (geschlossen)
HB.F = 3, 7 HB.F = 3, 7 HB.F = 3, 7	S18 (aperto) S18 (open) S18 (geöffnet)
Non utilizzato Not used Nicht verwendet	S21 S21 S21
Non utilizzato Not used Nicht verwendet	S22 S22 S22
Non utilizzato Not used Nicht verwendet	S23 S23 S23
OUT4 relè diseccitato power ON OUT4 relay OFF at power ON Ausgang 4; Relais angezogen = Kontakt geöffnet	S2 (posizione A) S2 (position A) S2 (Stellung A)
OUT4 relè eccitato power ON OUT4 relay ON at power ON Ausgang 4; Relais angezogen = Kontakt geschlossen	S2 (posizione B) S2 (position B) S2 (Stellung B)

(*) LC

DESCRIPTION DESCRIPCIÓN DESCRIÇÃO	PONTS ÉTAİN PUENTES PONTES
Validation configuration (Etanche) Habilitación configuración (Estaño) Habilitação da configuração (Estanho)	S3 (fermée) S3 (cerrado) S3 (fechado)
Validation configuration (jumper) Habilitación configuración (jumper) Habilitação da configuração (jumper)	S14 (fermée) * S14 (cerrado) * S14 (fechado) *
Validation étalonnage Habilitación calibración Habilitação da calibração	S4 (fermée) S4 (cerrado) S4 (fechado)
Non utilisé No utilizado Não utilizado	S7 S7 S7
Validation capteur PTC Habilitación sonda PTC Habilitação para sonda PTC	S13 (ouverte) S13 (abierto) S13 (aberto)
Validation capteur PT100 (standard) Habilitación sonda P100 (standard) Habilitação para sonda PT100 (standard)	S13 (fermée) S13 (cerrado) S13 (fechado)
HB.F = 0, 1, 2 HB.F = 0, 1, 2 HB.F = 0, 1, 2	S18 (fermée) S18 (cerrado) S18 (fechado)
HB.F = 3, 7 HB.F = 3, 7 HB.F = 3, 7	S18 (ouverte) S18 (abierto) S18 (aberto)
Non utilisé No utilizado Não utilizado	S21 S21 S21
Non utilisé No utilizado Não utilizado	S22 S22 S22
Non utilisé No utilizado Não utilizado	S23 S23 S23
OUT4 relais désexcité mise en marche OUT4 relé desexcitado con “power ON” OUT4 relé não excitado com alimentação ON	S2 (position A) S2 (posición A) S2 (posição A)
OUT4 relais excité mise en marche OUT4 relé excitado con “power ON” OUT4 relé excitado com alimentação ON	S2 (position B) S2 (posición B) S2 (posição B)

(*) LC

INGRESSO TA/SPR (PONTI A STAGNO)
CT/SPR INPUT (TIN JUMPERS)
STROMWANDLER-EINGANG / SPR (LÖTBRÜCKEN)
ENTRÉE TA/SPR (PONTS ÉTANCHES)
ENTRADA TA/SPR (PUENTES DE ESTA—O)
ENTRADA TA/SPR (PONTES COM ESTANHO)

	S9	S10	S11	S12	S15	S16
INGRESSO INPUT EINGANG ENTRÉE ENTRADA ENTRADA	PONTICELLI JUMPERS BRÜCKEN PONTS ÉTAİN PUENTES PONTES	PONTICELLI JUMPERS BRÜCKEN PONTS ÉTAİN PUENTES PONTES	PONTICELLI JUMPERS BRÜCKEN PONTS ÉTAİN PUENTES PONTES	PONTICELLI JUMPERS BRÜCKEN PONTS ÉTAİN PUENTES PONTES	PONTICELLI JUMPERS BRÜCKEN PONTS ÉTAİN PUENTES PONTES	PONTICELLI JUMPERS BRÜCKEN PONTS ÉTAİN PUENTES PONTES
SPR 0...1V	OFF	OFF	OFF	OFF	ON	ON
SPR 0...10V / Pot.	OFF	OFF	ON	OFF	ON	OFF
SPR 0/4...20mA	ON	OFF	OFF	OFF	ON	OFF
TA 50mA	ON	ON	OFF	ON	OFF	OFF

INGRESSI DIGITALI (DIP SWITCH S1)
 DIGITAL INPUTS (DIP SWITCH S1)
 DIGITALE EINGÄNGE (DIP SWITCH S1)
 ENTRÉES NUMÉRIQUES (DIP SWITCH S1)
 ENTRADAS DIGITALES (DIP SWITCH S1)
 ENTRADAS DIGITAIS (DIP SWITCH S1)

INGRESSI / TIPO INPUTS / TYPE EINGÄNGE / TYP ENTRÉES / TYPE ENTRADAS / TIPO ENTRADAS / TIPOS	NPN	PNP
INGRESSO DIGITALE 2 DIGITAL INPUT 2 DIGITALEINGANG 2 ENTRÉE NUMÉRIQUE 2 ENTRADA DIGITAL 2 ENTRADA DIGITAL 2	C = OFF	C = ON
INGRESSO DIGITALE 2 DIGITAL INPUT 2 DIGITALEINGANG 2 ENTRÉE NUMÉRIQUE 2 ENTRADA DIGITAL 2 ENTRADA DIGITAL 2	D = ON	D = OFF
INGRESSO DIGITALE 1 DIGITAL INPUT 1 DIGITALEINGANG 1 ENTRÉE NUMÉRIQUE 1 ENTRADA DIGITAL 1 ENTRADA DIGITAL 1	A = OFF	A = ON
INGRESSO DIGITALE 1 DIGITAL INPUT 1 DIGITALEINGANG 1 ENTRÉE NUMÉRIQUE 1 ENTRADA DIGITAL 1 ENTRADA DIGITAL 1	B = ON	B = OFF

USCITA ALIMENTAZIONE TRASMETTITORE (DIP SWITCHES S13)
 TRANSMITTER SUPPLY OUTPUT (DIP SWITCHES S13)
 AUSGANG FÜR SENSORSPEISUNG (DIP SWITCHES S13)
 SORTIE DE ALIMENTATION POUR TRANSMETTEUR (DIP SWITCHES S13)
 SALIDA DE ALIMENTACIÓN PARA TRANSMISOR (DIP SWITCHES S13)
 SAÍDA DE ALIMENTAÇÃO PARA TRANSMISSOR (DIP SWITCHES S13)

USCITA 10V OUTPUT 10V AUSGANGS 10V SORTIE 10V SALIDA 10V SAÍDA 10V	B = ON	A = OFF
USCITA 24V OUTPUT 24V AUSGANGS 24V SORTIE 24V SALIDA 24V SAÍDA 24V	A = ON	B = OFF

SCHEDA OUT SERIALE / OUT W
 SERIAL OUT BOARD / OUT W
 SERIELLER AUSGÄNGE / OUT W
 CARTE OUT SÉRIE / OUT W
 FICHA OUT SERIE / OUT W
 PLACA DE COMUNICAÇÃO DIGITAL / OUT W

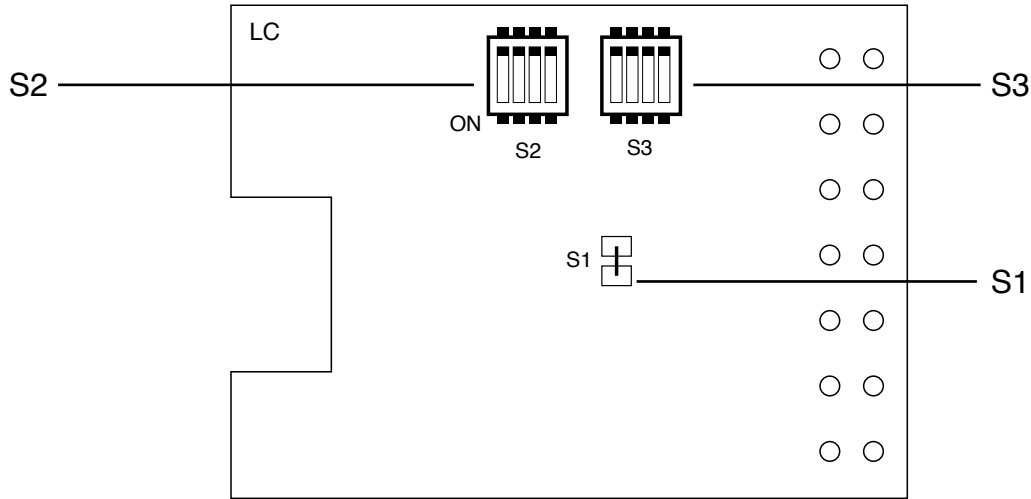

Fig. 3

USCITA ANALOGICA 1 (DIP SWITCHES S2)
 ANALOGUE OUTPUT 1 (DIP SWITCHES S2)
 ANALOGER AUSGANG 1 (DIP SWITCHES S2)
 SORTIE ANALOGIQUE 1 (DIP SWITCHES S2)
 SALIDA ANALÓGICA 1 (DIP SWITCHES S2)
 SAÍDA ANALÓGICA 1 (DIP SWITCHES S2)

USCITA ANALOGICA ANALOGUE OUTPUT ANALOGER AUSGANG SORTIE ANALOGIQUE SALIDA ANALÓGICA SAÍDA ANALÓGICA	S2 (ON)	S2 (OFF)
0/4...20mA	1	2-3-4
0...10V	2-4	1-3

USCITA ANALOGICA 2 (DIP SWITCHES S3)
 ANALOGUE OUTPUT 2 (DIP SWITCHES S3)
 ANALOGER AUSGANG 2 (DIP SWITCHES S3)
 SORTIE ANALOGIQUE 2 (DIP SWITCHES S3)
 SALIDA ANALÓGICA 2 (DIP SWITCHES S3)
 SAÍDA ANALÓGICA 2 (DIP SWITCHES S3)

USCITA ANALOGICA ANALOGUE OUTPUT ANALOGER AUSGANG SORTIE ANALOGIQUE SALIDA ANALÓGICA SAÍDA ANALÓGICA	S3 (ON)	S3 (OFF)
0/4...20mA	1	2-3-4
0...10V	2-4	1-3