

EXP-ETH-CAT-ADV

EtherCAT interface
expansion card

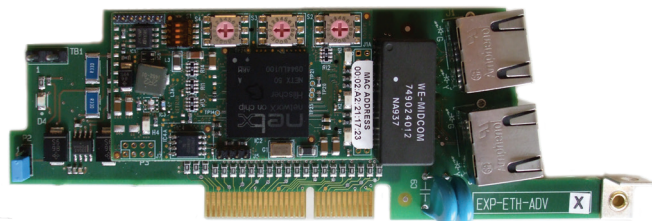

1S5F28, EXP-ETH-CAT-ADV -IT/EN
manual (rev rev 0.5 - 11-1-19)



Contents

Reinforced insulation	1
Introduction	1
Features	2
What is EtherCAT?	2
Safety	2
Mounting	2
Connections	2
Leds and Rotary switch	4
Optional card recognition	5
Quick start guide	6
1.0 Protocols	10
1.1 Process Data Objects (PDOs)	10
1.2 Service Data Object (SDO) parameter access	10
1.3 CANopen over EtherCAT (CoE)	10
1.4 Operation according to the DS402 profile	11
1.5 EtherCAT protocol support	13
1.6 Process Data Channel Control	13
1.7 In general	15

Reinforced insulation

PELV (Protective Extra Low Voltage) EN 61800-5-1.

Introduction

This manual describes the EXP-ETH-CAT-ADV option card aimed at connecting the ADV200 series Drives to EtherCAT networks.

It is possible to use only one field bus expansion card per Drive.

This manual is intended for design engineers and technicians responsible for the maintenance, commissioning and operation of EtherCAT systems.

Basic knowledge of EtherCAT is required. This is explained in detail in the document "EtherCAT Slave Device Description Version: V0.3.1".

Features

- Standard RJ45 with support for shielded twisted pair, half-duplex / full-duplex and 10Mbps / 100Mbps connectivity
- Dual 100Mbps EtherCAT interfaces for use in line topologies i.e. daisy chaining
- Control cycle times down to 1ms
- Configured Station Alias
- CANopen over EtherCAT (CoE) which includes:
 - Support of CANopen DSP-402 (Device Profile for Drives and Motion)
 - Velocity mode
 - Transmit and receive PDOs (one + one)
 - SDO access to all profile objects and drive parameters

What is EtherCAT?

EtherCAT is an open high performance Ethernet-based field bus system that overcomes the system limitations of other Ethernet solutions.

The Ethernet packet is no longer received, then interpreted and copied as process data at every connection; instead the Ethernet frame is processed on the fly.

The development goal of EtherCAT was to apply Ethernet to automation applications that require short data update times (also called cycle times) with low communication jitter (for synchronization purposes) and low hardware costs.

Typical application fields for EtherCAT are machine controls (i.e.. semiconductor tools, metal forming, packaging, injection moulding, assembly systems, printing machines, robotics and many others)

Safety

Before installing the card, read the safety instruction section carefully, see ADV200 Quick Start-up guide, Chapter 1 - Safety Precautions.

Mounting

Refer to ADV200 Quick Start up manual, chapter "**Installation of optional cards**": **the card must be inserted on slot 3.**

Connections

Bus media

The EtherCAT option module incorporates two 100 BASE-TX RJ45 interfaces.

Cabling considerations

To ensure long-term reliability it is recommended that any cables used to connect a system together be tested using a suitable Ethernet cable tester, this is of particular importance when cables are constructed on site.

Cable

Cables should be shielded and as a minimum, meet TIA Cat 5e requirements.

Cabling issues are the single biggest cause of network downtime. Ensure cabling is correctly routed, wiring is correct, connectors are correctly installed and any

switches or routers used are rated for industrial use. Office grade Ethernet equipment does not generally offer the same degree of noise immunity as equipment intended for industrial use.

Maximum network length

The main restriction imposed on Ethernet cabling is the length of a single segment of cable.

The ADV-EtherCAT module has two 100BASE-TX Ethernet ports, which support segment lengths of up to 100m. This means that the maximum cable length which can be used between one ADV-EtherCAT port and another 100BASE-TX port is 100m however it is not recommended that the full 100m cable length is used.

The total network length is not restricted by the Ethernet standard but depends on the number of devices on the network and the transmission media (copper, fiber optic, etc.).

The EtherCAT system designer must consider the impact that the selected network structure will have on performance.

ADV-EtherCAT terminal descriptions

The ADV-EtherCAT module has two RJ45 Ethernet ports for the EtherCAT network.

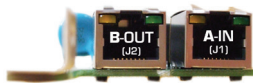

EtherCAT terminal connections			
Pin	A - IN (J1)	Pin	B - OUT (J2)
1	Transmit +	1	Transmit +
2	Transmit -	2	Transmit -
3	Receive +	3	Receive +
4	Not used	4	Not used
5	Not used	5	Not used
6	Receive -	6	Receive -
7	Not used	7	Not used
8	Not used	8	Not used

Network topology

Gefran recommend implementing daisy chaining on EtherCAT networks.

Other Ethernet network topologies can be used but care must be taken to ensure that the system still operates within the constraints specified by the designer.

Minimum node-to-node cable length

There is no minimum length of cable recommended in the Ethernet standards.

To avoid possible problems it is recommended that you allow sufficient cable length to ensure good bend radii on cables and avoid unnecessary strain on connectors.

Leds and Rotary switch

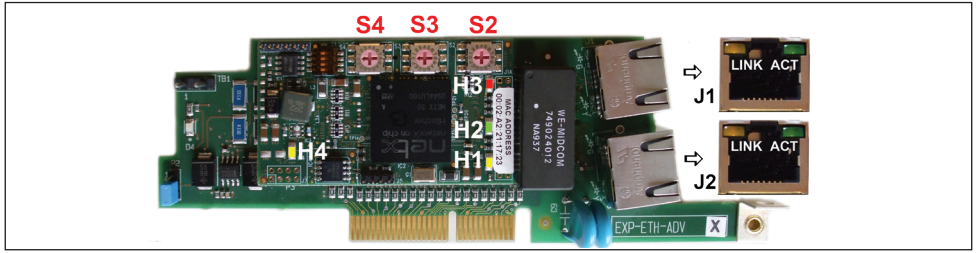

LEDs				
Reference	Color	Display	Status	Descriptions
LINK (J1) (Eth0 IN)	yellow	off	-	no connection with the previous EtherCAT client
		on	linked	previous EtherCAT-client connected
ACT (J1) (Eth0 IN)	green	blinking	active	communication with the previous EtherCAT client
		off	-	no connection with the previous EtherCAT client
		on	-	no communication with the previous EtherCAT client
LINK (J2) (Eth1 OUT)	yellow	off	-	no connection with the next EtherCAT client
		on	linked	next EtherCAT client connected
ACT (J2) (Eth1 OUT)	green	blinking	active	communication with the next EtherCAT client
		off	-	no connection with the next EtherCAT client
		on	-	o communication with next previous EtherCAT client
H1 (RDY)	yellow			Indicates the processor mode. Flashes in boot mode. Off when the software is installed.
H2 (RUN)	green			Indicates that the processor is executing a software program. On when the processor is executing the program. Off in boot mode.
H3 (FAIL)	red			Indicates a system malfunction. Lit when errors are present. Flashes once at power-on.
H4 (PWR)	yellow			Indicates the presence of the card power supply. Lit when the card is powered.
ROTARY SWITCH				
Reference				Descriptions
S2				Node address for 1
S3				Node address for 10
S4				Node address for 100

Optional card recognition

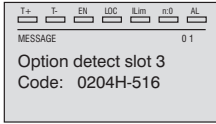

At power-on, the drive recognizes the presence of optional card in the expansion slot 3, this message is shown on the display.

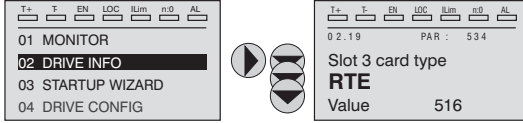

On 02 DRIVE INFO menu, select the PAR 534 Slot 3 card type to read the recognized card type.

Value	Description	Card type
0	None	-
516	RTE	EXP-ETH-CAT-ADV
255	Unknown	-

Quick start guide

This section is intended to provide a generic guide for setting up module with a master/controller PLC. It will cover the basic steps required to get cyclic data communicating using the CANopen over EtherCAT (CoE) protocol on the module.

Gefran XML file

Gefran provides an EtherCAT device description file (Gefran_Adv200.xml) and the customer parameters “Manufacturing Specific Area” (ADV200.eds file).

Gefran_Adv200.xml file provides the master with information about the EtherCAT module to aid with its configuration.

You can download the “Gefran_Adv200.xml” and “ADV200.eds” files from our website: www.gefran.com.

Configuring the -EtherCAT module for cyclic communications

CoE does not require that any module parameters be changed in order to achieve communications.

The baud rate of the network is fixed and the module is automatically allocated an address (see “ADV-EtherCAT Node address” paragraph).

To check that the Ethernet cable connected to the EtherCAT module on the drive is connected correctly, look at the LED on the front of the EtherCAT module relating to the connector being used, if this light is a solid green colour then a link is established with the master, if this light is off then check the cabling and also check that the master has started communications.

In the master, scan the network ensuring that the EtherCAT module is connected correctly to the master. If the network is configured correctly the EtherCAT node(s) should be visible in the PLC master.

Decide on the input / output data you wish to send cyclically (objects and/or parameters).

Cyclic data is implemented on CoE networks by using “Process Data Objects” or PDOs.

Separate data objects are used for receiving (TxPDOs - from the slave to the master) and transmitting (RxPDOs - from the master to the slave) data.

Sync manager configuration

The sync managers are the EtherCAT means for setting access attributes for different areas of memory and triggering or notifying the application when the memory is accessed. The following objects specify how the sync managers (and thus corresponding memory areas) are utilized by the CoE protocol.

Assigning TxPDO to the sync manager

To assign TxPDO1 to sync manager 3 PDO assignment set the values below to the following objects:

- Index: 0x1C13
- Sub index: 0x00
- Size: 1
- Value: 1

Setting object 0x1C13, sub-index 0 to a value of 1 (as above) indicates that TxPDO will be assigned to the sync manager 3 assignment.

- Index: 0x1C13
- Sub index:0x01
- Size: 2
- Value: 0x1A00

Setting object 0x1C13, sub-index 1 to a value of 0x1A00 maps TxPDOX to the process data input sync.

Assigning RxPDO to the sync manager

To assign RxPDO1 to sync manager 3 PDO assignment set the values below to the following objects:

- Index: 0x1C12
- Sub index:0x00
- Size: 1
- Value: 1

Setting object 0x1C12, sub-index 0 to a value of 1 (as above) indicates that RxPDO will be assigned to the sync manager 3 assignment.

- Index: 0x1C12
- Sub index:0x01
- Size: 2
- Value: 0x1600

Setting object 0x1C12, sub-index 1 to a value of 0x1600 maps RxPDOX to the process data input sync.

Download the configuration to the master

After downloading the configuration to the master the LED(s) on the front of the EtherCAT should flash, depending on the port(s) connected.

Values written to parameters over RxPDOs should now be viewable using the drive's keypad so long as the master has put the slave into the operational state; also, parameter values changed using the drive keypad will be updated on the master.

ADV-EtherCAT Node address

It is not necessary for a user to set a node address manually in order to initiate EtherCAT communications; however, this parameter can be used to configure an EtherCAT Station Alias.

The master recognizes the card according to its position in the network or via the address in a "HotConnect Group". In the latter case, the address is given by parameter 4006 "Fieldbus address" if this is other than 0, or by the rotary switches on the module if = 0.

Rotary switches (see "Leds and Rotary switches" chapter)

S2: normally indicates the units in the physical address of the node.

S3: normally indicates the tens in the physical address of the node.

S4: normally indicates the hundreds in the physical address of the node.

Example of configuration of a physical address: to set the address to 125 set the rotary switches as follows: S2 = 5, S3 = 2, S4 = 100.

Menu Fieldbus

To enable the EXP-ETH-CAT-ADV card set PAR 4000 **Fieldbus type** as “RTE” or “DS402”.

The following parameters are available in the COMMUNICATION->FIELDBUS CONFIG menu:

PAR	Parameter description	Type	Default value	Attr
4006	Fieldbus address	2 byte unsigned	0	Write
4010	Fieldbus M->S enable	Enum	0n	Write
4012	Fieldbus alarm mode	2 byte unsigned	0	Write
4014	Fieldbus state	Enum	Stop	Read only
4398	RTE protocol	Enum	None	Read only

- Fieldbus address = address of this slave node in the network, accepted values see “ADV-EtherCAT Node address” chapter.
- Fieldbus M->S enable = if set to Off the data the PLC sends the drive (master to slave) are not updated anymore by the drive and the current values are maintained
- Fieldbus alarm mode = if set to On the drive generates **Opt Bus Fault** errors relating to the loss of communication (Bus Loss) even when the drive is not enabled.
- Fieldbus state = state of the communication on the RTE network :

Ethercat	PAR 4014 Fieldbus state
Boot	Stop
Init	Init
Pre-operational	Pre-operational
Safe-op	Safe-op
Operational	Operational

- RTE Protocol = Ethercat

Quick start procedure

Guided procedure for setting the drive to cyclic communication mode in Ethercat

1. Set the Fieldbus Type parameter to RTE (IPA 4000)

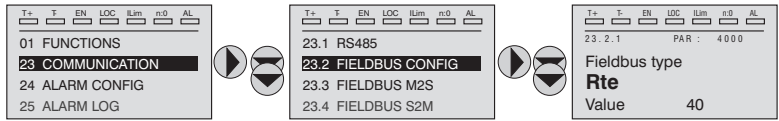

2. Save and reboot
3. Check that the RTE protocol parameter (IPA 4398) is set to Ethercat

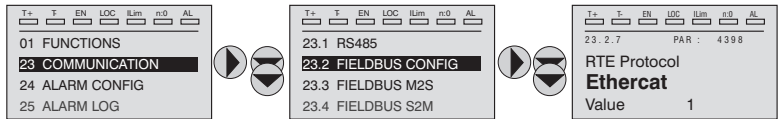

4. Check the LEDs of the RTE_ETH card --> **see page 5**
5. Check that the correct xml file is in the correct position in the master
6. Run a network scan in the master
7. Configure the necessary PDO mappings --> **see page 13**
8. Download to the master (if necessary) and start communication
9. Check that the fieldbus state (IPA 4014) is set to Operational

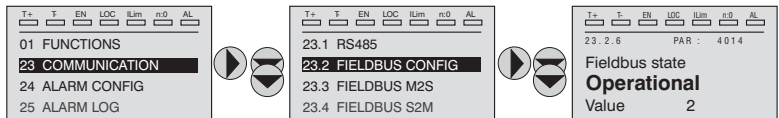

Specific codes for the OptBusFault alarm

0xFF02	Communication with the module not available DPRAM not recognized. Replace the module
0xFF04	Module software version not compatible
0x8101	NetX system error. If not recoverable, replace the module.
0x8102,0x8104	DPRAM Error, after WarmStart. If not recoverable, replace the module
0x8110	Not Ready timeout, NetX not available. If not recoverable, replace the module.
0	Bus Loss : connection with the master no longer present or Ethercat state no more Operational
FF01	Fieldbus type does not match expansion card : verify if EXP-ETH-CAT-ADV card is properly installed

1.0 Protocols

1.1 Process Data Objects (PDOs)

Cyclic data is implemented on EtherCAT networks by using “Process Data Objects” or PDOs. Separate data objects are used for transmitting (TxPDOs) and receiving (RxPDOs) data. PDO configuration objects are usually pre-configured in the EtherCAT master controller and downloaded to the EtherCAT at network initialization using SDOs.

1.2 Service Data Object (SDO) parameter access

The service data object (SDO) provides access to all objects in the EtherCAT object dictionary and the drive parameters are mapped into the object dictionary as 0x2XXX objects.

The SDO service is always available.

The drive parameters can be accessed via the “MSPA” Manufacturer Specific Profile Area (2000hex < index < 5FFFhex).

The index to be shown in the SDO command to access a drive parameter is obtained via the following rules:

SDO index = PAR + 2000h

SDO subindex = 1

Example:

Writing the value 1000 in the PAR 600 **Dig Ramp ref 1** parameter (258hex).

The following information is required:

1. The SDO index resulting from the formula is: 2000hex + 258hex = 2258h
2. The value to be written is 1000, corresponding to 03E8 hex.

Index		Subindex				
22h	58h	01h	E8h	03h	00h	00h
Drive parameter index		Subindex	Drive parameter value to be assigned to SDO			

1.3 CANopen over EtherCAT (CoE)

The CoE protocol over EtherCAT uses a modified form of the CANopen object dictionary. This is specified in table 1.3.1.

Index	Object dictionary area
0x0000 to 0x0FFF	Data type area
0x1000 to 0x1FFF	CoE communication area
0x2000 to 0x1FFF	Manufacturer specific area
0x6000 to 0x1FFF	Profile area
0xA000 to 0x1FFF	Reserved area

The object description format describes object related information such as size, range and descriptions and is detailed in Table 1.3.2:

Table 1.3.2 - Object description format			
<index>	<object name>		
Access: <access>	Range: <range>	Size: <size>	Unit: <unit>
Default; <default>			
Description: <description>			

For entries having sub-indices:

Table 1.3.3 - Object description format with sub-indices			
<index>	<object name>		
sub-index 0			
Access: <access>	Range: <range>	Size: <size>	Unit: <unit>
Default; <default>			
Description: <description>			
sub-index 1			
Access: <access>	Range: <range>	Size: <size>	Unit: <unit>
Default; <default>			
Description: <description>			
...			
Access: <access>	Range: <range>	Size: <size>	Unit: <unit>
Default; <default>			
Description: <description>			
sub-index n-1			
Access: <access>	Range: <range>	Size: <size>	Unit: <unit>
Default; <default>			
Description: <description>			
sub-index n			
Access: <access>	Range: <range>	Size: <size>	Unit: <unit>
Default; <default>			
Description: <description>			

Definitions:

- <index> : A signed 16-bit number. This is the index of the object dictionary entry specified in four hexadecimal characters.
- <access> : A value describing how the object may be accessed (RW = read/write, RO = read-only and WO = write-only).
- <size> : The size of the object/sub-index in bytes.
- <unit> : The physical unit (e.g. ms, counts per second etc.).

1.4 Operation according to the DS402 profile

If the PAR 4000 **Fieldbus type** parameter is set to DS402 the drive works with the standard profile for Drives & Motion Control Ver 2.0 and contains Device Identity 192H (402) in object 1000h.

The ADV200 drive supports Velocity Mode.

In the default configuration the drive is automatically set to use PDOs No. 6 , mapped onto RPDO1 and TPDO1.

PDO	Object Number	Object Name	Description
6	6040h	Controlword	controls the state machine and the nominal speed (vl)
	6042h	Target velocity (vl)	
6	6041h	Statusword	shows status and the current speed (vl)
	6044h	vl control effort	

The remaining PDOs can be set by the user.

The following DS402 objects are implemented:

Object no.		Description	Type	Access	Mandatory
6040h	VAR	Controlword	UNSIGNED16	rw	M
6041	VAR	Statusword	UNSIGNED16	ro	M
6042h	VAR	vl target velocity (1)	INTEGER16	rw	M
6043h	VAR	vl velocity demand (1)	INTEGER16	ro	M
6044h	VAR	vl control effort(1)	INTEGER16	ro	M
6046h	ARRAY	vl velocity min max amount	UNSIGNED32	rw	M
6048h	RECORD	vl velocity acceleration	vl velocity acceleration	rw	M
6049	RECORD	vl velocity deceleration	vl velocity deceleration	rw	M
6060h	VAR	Modes of operation (2)	INTEGER8	rw	M
6061h	VAR	Modes of operation display	INTEGER8	ro	M

- (1) The unit of measure for objects 6042h, 6043h, 6044h is expressed in rpm
- (2) Object 6060h is only available in that it is mandatory. As the drive only supports Velocity Mode, the value of this object is not modifiable.

The device operates as a DS402 state machine (refer to CiA DSP 402 V 2.0, section 10.1.1):

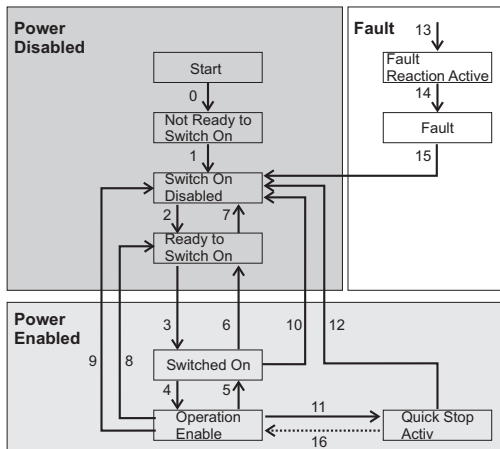

1.5 EtherCAT protocol support

The following are supported:

- Four Sync Managers. Two are used for the Mailbox Protocol (non-cyclic data) and two are used for process data (cyclic data)
- CANopen over EtherCAT (CoE)

Abort code

Generic Error: the RTE module ignores the signal associated with the SDO.

1.6 Process Data Channel Control

This function allows to allocate the drive parameters or application variables to the Process Data Channel data.

The ADV200 Ethercat interface uses a number of words for the Process Data Channel (abbr. PDC Process Data Channel), which can always be set.

The Process Data Channel configuration for the ADV200 interface is the following:

DATA0 DATA... DATAn

The Slave can both read and write the Process Data Channel data.

The Ethercat data read by the Slave are defined as input data; the data written in Ethercat by the Slave are defined as output data.

A datum can be made both of 2 and 4 bytes. The word "data" refers to any quantity of bytes included between 0 and 16, if the byte total number required is not higher than 32.

Example:

It is possible to have:

- from 0 to 16 data items of 2 byte
- 1 datum of 4 bytes + from 0 to 14 data items of 2 bytes
- 2 data items of 4 bytes + from 0 to 12 data items of 2 bytes
- ...
- 8 data items of 4 bytes

The data exchanged via the PDC can be of two types:

- drive parameters
- variables of an MDPIc application

The composition of the PDC input and output data is defined via suitable parameters as described in the following paragraphs.

The master cyclically writes the data defined as PDC input and cyclically reads the data defined as PDC output.

1.6.1 PDC Input Configuration

Data exchanged in RPDOs are configured using the parameters in the COMMUNICATION->FIELD BUS M2S menu (refer to the drive manual).

1.6.2 PDC Output Configuration

Data exchanged in RPDOs are configured using the parameters in the COMMUNICATION->FIELDBUS S2M menu (refer to the drive manual).

1.6.3 Configuration of the Virtual Digital I/Os

The ADV200 firmware, provides the **Word Comp** and **Word Decomp** functions, which allows to exchange discrete signals between the master and the slave and vice versa.

Commands can be sent to the drive using the functions of PAR 4452 **Word decomp src**. The meaning of the single bits is programmable. It can be set on a Field bus M->Sn channel as Count 6.

The drive state is read in PAR 4432 **Word Comp mon**, programmable on any Field bus S->Mn channel as Count 6. The meaning of each single bit can be selected by the user using PAR 4400 **Word Bit 0 src** ... PAR 4430 **Word Bit 15 src**.

For a detailed description of these parameters see the drive manual.

1.6.4 Use of the PDC in MDPIc Applications

It is possible to configure both the PDC input and output data in order to allow the data direct access via the MDPIc application code.

1.7 In general

1.7.1 Glossary

Master	PLC or PC device controlling the Ethercat; it has the right to access the Bus.
Slave	Drive or I/O modules which have no right to access the Bus
Process Channel	Channel for a fast, cyclical and high-priority data transfer of previously configured parameters.
Configuration Channel	Channel for a non-cyclical and low-priority data transfer used, for example, for the drive configuration
DSP402	Device profile for drives and motion control.

1.7.2 Abbreviations

μ C	Microcontroller
C	Conditional
CMD	Command
DC	Distributed Clock
ECAT	EtherCAT
EOF	End of Frame
ESC	EtherCAT Slave Controller
FMMU	Field bus Memory Management U
I/O	Input or Output
IRQ	Interrupt Request
M	mandatory
MAC	Media Access Controller
MI (PHY)	Management Interface
MII	Media Independent Interface
O	Optional
OD	Object Dictionary
PDC	Process Data Channel
PDO	Process Data Object
RD	Read
SDO	Service Data Object
SM	SyncManager
SOF	Start of Frame
SPI	Serial Peripheral Interface
WD	Watchdog
WKC	Working Counter
WR	Write

1.7.3 References

1. "EtherCAT Slave Device Description Version: V0.3.1".
2. ADV200 "Quick Start-up guide - Specification and installation" manual
3. ADV200 "Functions description and parameters" list manual

