

PROGRAMMING and CONFIGURATION

SOFTWARE VERSION 1.5x
Code 80347E / Edition 0.3 - 02/19

To integration of the manuals:
- Geflex 25/120 (cod. 80331E)
- Geflex Multifunzione (cod. 80345C)
- Geflex Valvole (cod. 80346B)

TABLE OF CONTENTS

	Page		Page
1 Programming and configuration	2	1.13 PID heat/cool configuration	20
1.1 Main input	3	1.14 Autotuning, Selftuning, Softstart	22
1.2 CT auxiliary input	4	1.15 Software Off	25
1.3 VT auxiliary input	5	1.16 Manual configuration	26
1.4 LIN/TA.EXT/POT auxiliary input	5	1.17 Manual power correction based on grid voltage	26
1.5 Digital input	6	1.18 Hot channels configuration	27
1.6 Output	6	1.19 Valves parameter	29
1.7 Function of Geflex "Master" relay	6	1.20 Configuration of outputs if expansion RR/CC is present	30
1.8 AL.1/2/3/4 alarms	9	1.21 Serial	30
1.9 LBA alarm	13	1.22 Configuration of virtual instrument	31
1.10 HB alarm	15	1.23 Information on instrument	32
1.11 Alarm due to probe in short or incorrect connection (SBR-ERR)	17		
1.12 SP configuration	17		

1 • PROGRAMMING and CONFIGURATION

The programming parameters have been divided into groups of use. There is a section pertaining to setting the alarms, the Heat/Cool PID, etc. Parameters are described at several points since their context of use will change.

The description of parameters follows this scheme:

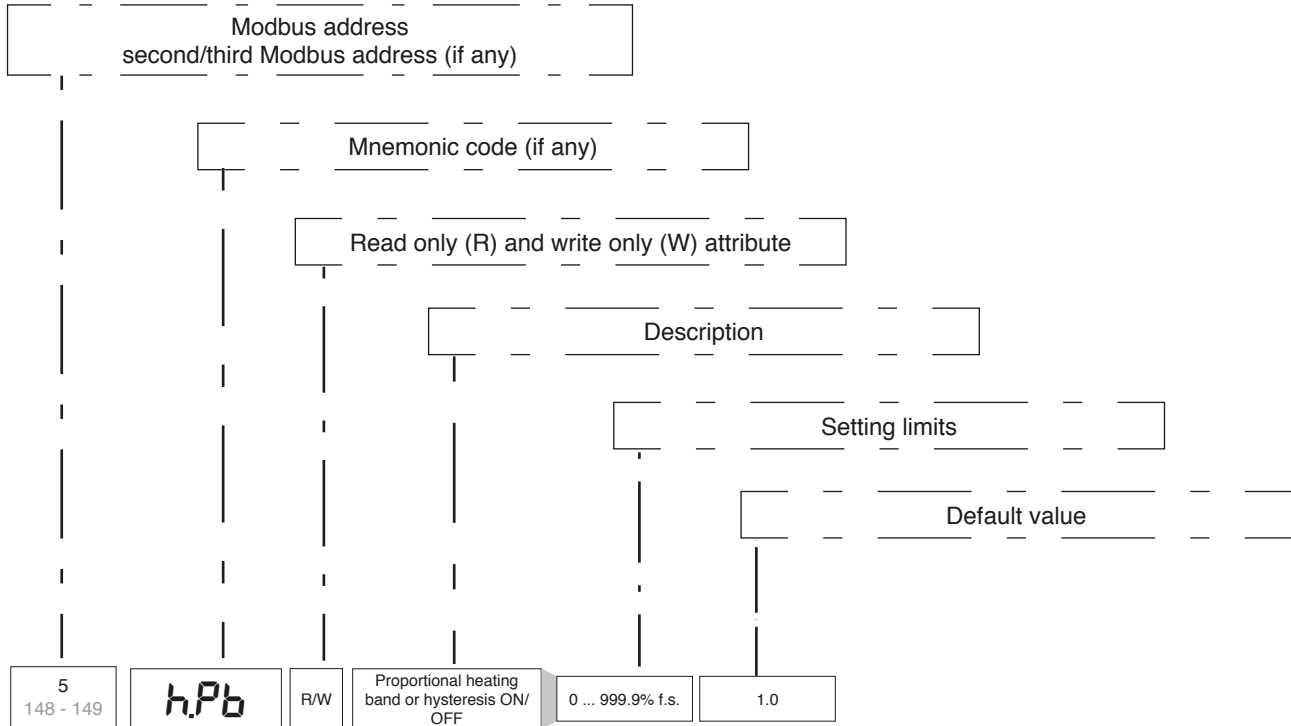

Unless otherwise specified, the addresses are in decimal format and represent 16-bit words.

Any second/third Modbus addresses are alternate to the main address given.

Each paragraph has a section dealing with the **setting** parameters, i.e., a list of the parameters involved in activating/setting a certain function.

The **states** section deals with parameters that provide information on the function setting made.

Unless specified in the paragraph, the parameters are settable for all Geflex models.

1.1 Main input

Input always present, to which a temperature or linear sensor can be connected.

Settings

400 **tyP.** R/W Probe type, signal, enable custom linearization, and main input scale 0

For custom linearization:
 - The LO signal is given with variable at values below Lo.S or at minimum calibration value
 - The HI signal is given with variable at values above Lo.S or at maximum calibration value

PROBE: TC				
Type	Probe type	Scale	Without dec. point	With dec. point
0	TC J	°C	0/1000	0.0/999.9
1	TC J	°F	32/1832	32.0/999.9
2	TC K	°C	0/1300	0.0/999.9
3	TC K	°F	32/2372	32.0/999.9
4	TC R	°C	0/1750	0.0/999.9
5	TC R	°F	32/3182	32.0/999.9
6	TC S	°C	0/1750	0.0/999.9
7	TC S	°F	32/3182	32.0/999.9
8	TC T	°C	-200/400	-199.9/400.0
9	TC T	°F	-328/752	-199.9/752.0
28	TC	custom	custom	custom
29	TC	custom	custom	custom

For custom linearization:
 - The LO signal is given with variable at values below Lo.S or at minimum calibration value
 - The HI signal is given with variable at values above Lo.S or at maximum calibration value

PROBE: RTD 3 wires				
Type	Probe type	Scale	Without dec. point	With dec. point
30	PT100	°C	-200/850	-199.9/850.0
31	PT100	°F	-328/1562	-199.9/999.9
32	JPT100	°C	-200/600	-199.9/600.0
33	JPT100	°F	-328/1112	-199.9/999.9

PROBE: Voltage 60mV				
Type	Probe type	Scale	Without dec. point	With dec. point
34	0...60 mV	linear	-1999/9999	-199.9/999.9
35	0...60 mV	linear	linear custom	linear custom
36	12...60 mV	linear	-1999/9999	-199.9/999.9
37	12...60 mV	linear	linear custom	linear custom

PROBE: Current 20mA				
Type	Probe type	Scale	Without dec. point	With dec. point
38	0...20 mA	linear	-1999/9999	-199.9/999.9
39	0...20 mA	linear	linear custom	linear custom
40	4...20 mA	linear	-1999/9999	-199.9/999.9
41	4...20 mA	linear	linear custom	linear custom

PROBE: Voltage 1V				
Type	Probe type	Scale	Without dec. point	With dec. point
42	0...1 V	linear	-1999/9999	-199.9/999.9
43	0...1 V	linear	linear custom	linear custom
44	200mv..1V	linear	-1999/9999	-199.9/999.9
45	200mv..1V	linear	linear custom	linear custom

PROBE: Custom				
Type	Probe type	Scale	Without dec. point	With dec. point
46	Cust 20mA	-	-1999/9999	-199.9/999.9
47	Cust 20mA	-	linear custom	linear custom
48	Cust 60mV	-	-1999/9999	-199.9/999.9
49	Cust 60mV	-	linear custom	linear custom
50	PT100-JPT	-	custom	custom

Max. non-linearity error for thermocouples (TC), temperature thermometer (PT100)

Tc type J,K	error <0,2%f.s.
S, R	scale 0...1750°C; error < 0,2% f.s. (t > 300°C) for other scales; error < 0,5% f.s.
T	error <0,2% f.s. (t > -150°C)
and also by inserting a custom linearization	
E,N,L	error <0,2%f.s.
B	scale 44...1800°C; error < 0,5% f.s. (t > 300°C) scale 44,0...999,9; error f.s.(t>300°C)
U	scale -200...400; error < 0,2% f.s. (for t > -100°C) for other scales; error <0,5% f.s.
G	error < 0,2% f.s. (t > 300°C)
D	error < 0,2% f.s. (t > 200°C)
C	scale 0...2300; error < 0,2% f.s. for other scales; error < 0,5% f.s.
JPT100 and PT100	error < 0,2% f.s.

Error is calculated as shift from theoretical value with reference in % of full scale value expressed in degrees Celsius (°C)

24 **FLt** R/W Digital filter on input (if=0 excludes average filter on sampled value) 0.0 ... 20.0 sec 0,1

179 **FLd** R/W Input digital filter (P.V.) 0 ... 9.9 scale points 0,5

403 **dP.S** R/W Decimal point position for input scale

dP_S	Format
0	xxxx
1	xxx.x
2	xx.xx (*)
3	x.xxx (*)

0 (*) not available for TC, RTD and PTC probes

401 **Lo.S** R/W Minimum limit of main input scale min...max input scale selected in tyP 0

402 **Hi.S** R/W Maximum limit of main input scale min...max input scale selected in tyP 1000

519 **oFS.** R/W Offset correction of main input -999 ... 999 scale points 0

FOR CUSTOM PROBES ONLY

Linearization

86	5.00	R/W	Step 0 start scale value	(-1999...9999)	0
..... The value of step n corresponds to input: $mV \text{ start scale} + n \cdot \Delta mV$ $\Delta mV = (mV \text{ full scale} - mV \text{ start scale}) / 32$					
118	5.32	R/W	Step 32 (full scale value)	(-1999...9999)	1000
293	5.33	R/W	Step 33	mV start scala (-19.99...0)	0
294	5.34	R/W	Step 34	mV full scala (-19.9 ... 99.99)	Only for TYP = Tc Custom 0
295	5.35	R/W	Step 35	mV at temperature of 50°C (1.999 ... 9.999)	0

Status

0 470	P.V.	R	Process variable
4	---	R	Deviation S.P. - P.V.
349	---	R	Process variable after digital filter FLd

1.2 CT auxiliary input (internal current transformer)

Settable for models with diagnostics options C0, CV.

Optional input, used to monitor current delivered to load. Available variables: TA1 for currents delivered by instrument, TA2, TA3 for currents delivered by any expansion modules (typical application for 3-phase loads).

Automatic recognition of presence of internal current transformer.

Settings

405	HtA1	R/W	Max. limit Input scale current transformer (CT fase 1), auxiliary input	0.0 ... 999.9
529	GtA2	R/W	Gain input TA2 or mV f.s.	0.0 ... 100.0 mV
413	HtA2	R/W	Max. limit Input scale current transformer (CT fase 2)	0.0 ... 999.9
530	GtA3	R/W	Gain input TA3 or mV f.s.	0.0 ... 100.0 mV
414	HtA3	R/W	Max. limit Input scale current transformer (CT fase 3)	0.0 ... 999.9
220	o.tA1	R/W	Offset correction current transformer input (CT fase 1), auxiliary input	-99.9 ... 99.9 scale points
415	o.tA2	R/W	Offset correction current transformer input (CT fase 2)	-99.9 ... 99.9 scale points
416	o.tA3	R/W	Offset correction current transformer input (CT fase 3)	-99.9 ... 99.9 scale points
219	FtA	R/W	CT input digital filter (fase 1, 2, 3), auxiliary input (if = 0 excludes average filter on sampled value)	0.0 ... 20.0 sec

Models

5...15	25...40	60...120
15	40	120
15	40	120
15	40	120

Status

227 473 - 139	I.tA1	R	Ammeter input value (fase 1), auxiliary input, remote set point, valve position
468	---	R	InTA1on (VALAUX_ON) Current input value (phase 1) during ON time
490	I.tA2	R	Ammeter input value (fase 2)
498	---	R	InTA2on (VAL_TA2_ON) Current input value (phase 2) during ON time
491	I.tA3	R	Ammeter input value (fase 3)
499	---	R	InTA3on (VAL_TA3_ON) Current input value (phase 3) during ON time

Note: the thresholds HtA2, HtA3 are active with HbF = +16 only see paragraph 1.10

1.3 VT auxiliary input

Set for models with diagnostics option CV.

Optional input, used to monitor current delivered to load. Available variables: TV1 for voltages delivered by instrument, TV2, TV3 for voltages delivered by any expansion modules.

Automatic recognition of presence of internal voltmeter transformer.

Settings

410	H.tU1	R/W	Max. limit input scale voltage transformer (TV fase 1)	0.0 ... 999.9	100,0
417	H.tU2	R/W	Max. limit input scale voltage transformer (TV fase 2)	0.0 ... 999.9	100,0
418	H.tU3	R/W	Max. limit input scale voltage transformer (TV fase 3)	0.0 ... 999.9	100,0
411	a.tU1	R/W	Offset correction voltage transformer input (TV fase 1)	-99.9 ... 99.9 scale points	0,0
419	a.tU2	R/W	Offset correction voltage transformer input (TV fase 2)	-99.9 ... 99.9 scale points	0,0
420	a.tU3	R/W	Offset correction voltage transformer input (TV fase 3)	-99.9 ... 99.9 scale points	0,0
412	F.t.tU	R/W	VT input digital filter (fase 1, 2, 3) (if = 0 excludes average filter on sampled value)	0.0 ... 20.0 sec	0,1

Status

232 485	tU1	R	Voltmetric input value (fase 1)
492	tU2	R	Voltmetric input value (fase 2)
493	tU3	R	Voltmetric input value (fase 3)

1.4 LIN / POT auxiliary input

Set for Geflex Multifunction models (GFX-M2, GFX-S2) with diagnostics option IM, PO.

Optional input definable at time of order (LIN Multifunction Input, POT Potentiometer).

Automatic recognition of presence of input.

Settings

194	A.I.2	R/W	Selection of probe type for aux input	<table border="1"> <thead> <tr> <th>AI.2</th> <th>Signal</th> </tr> </thead> <tbody> <tr> <td>0</td> <td>0 ... 10V</td> </tr> <tr> <td>1</td> <td>2 ... 10V</td> </tr> <tr> <td>2</td> <td>0 ... 20mA</td> </tr> <tr> <td>3</td> <td>4 ... 20mA</td> </tr> <tr> <td>4</td> <td>Potentiometer</td> </tr> </tbody> </table>	AI.2	Signal	0	0 ... 10V	1	2 ... 10V	2	0 ... 20mA	3	4 ... 20mA	4	Potentiometer	0														
AI.2	Signal																														
0	0 ... 10V																														
1	2 ... 10V																														
2	0 ... 20mA																														
3	4 ... 20mA																														
4	Potentiometer																														
181	tP.2	R/W	Auxiliary analogue input function	<table border="1"> <thead> <tr> <th rowspan="2">tP.2</th> <th rowspan="2">auxiliary input function</th> <th colspan="2">SETTING LIMITS</th> </tr> <tr> <th>LS.2</th> <th>H.tA1</th> </tr> </thead> <tbody> <tr> <td>0</td> <td>none</td> <td>-</td> <td>-</td> </tr> <tr> <td>1</td> <td>remote setpoint</td> <td>Absolute Lo.S relative -999</td> <td>Absolute Hi.s relative +999</td> </tr> <tr> <td>2</td> <td>analogue remote manual</td> <td>-100.0%</td> <td>+100.0%</td> </tr> <tr> <td>3</td> <td>analogue power reset</td> <td>-100.0%</td> <td>+100.0%</td> </tr> <tr> <td>5</td> <td>valve position</td> <td>0.0</td> <td>+100.0%</td> </tr> </tbody> </table>	tP.2	auxiliary input function	SETTING LIMITS		LS.2	H.tA1	0	none	-	-	1	remote setpoint	Absolute Lo.S relative -999	Absolute Hi.s relative +999	2	analogue remote manual	-100.0%	+100.0%	3	analogue power reset	-100.0%	+100.0%	5	valve position	0.0	+100.0%	0
tP.2	auxiliary input function	SETTING LIMITS																													
		LS.2	H.tA1																												
0	none	-	-																												
1	remote setpoint	Absolute Lo.S relative -999	Absolute Hi.s relative +999																												
2	analogue remote manual	-100.0%	+100.0%																												
3	analogue power reset	-100.0%	+100.0%																												
5	valve position	0.0	+100.0%																												
404	LS.2	R/W	Minimum limit of auxiliary input	-1999 ... 9999	0																										
405	H.tA1	R/W	Maximum limit of auxiliary input	-1999 ... 9999	100,0																										
220	a.tA1	R/W	Offset correction auxiliary input	-99.9 ... 99.9 scale points	0,0																										
219	F.t.tA	R/W	Digital filter auxiliary input (if = 0 excludes average filter on sampled value)	0.0 ... 20.0 sec	0,1																										

Status

227 473 - 139	tA1	R	Auxiliary input value, remote set point, valve position
------------------	-----	---	---

1.5 Digital input

Input always present: can take on various functions.

HOLD FUNCTION

The input value and the trip points remain "frozen" for the interval in which the logic input is active.

By activating the Hold input with the variable at a value below the alarm setpoint, a memory latch reset causes the de-energizing of all energized relays and the memory reset of all alarms.

Settings

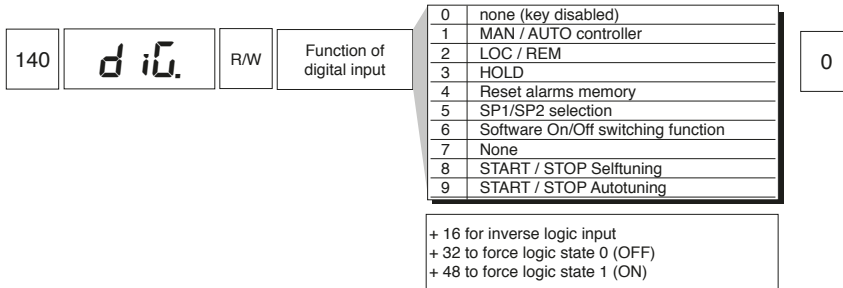

Status

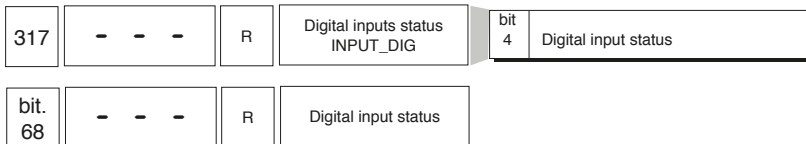

1.6 Output

Various output types are available: ON; OFF; PWM; GTT;

1.7 Function of Geflex "Master" relay

The "OUT3" and "OUT4" relays on the Geflex Master module provide special functions designed to reduce user wiring. These functions are active even when the Geflex Master module is not powered.

- The "OUT3" relay can be energized by the "rL3" command of the Geflex Master and by the "rL5" command of each Geflex Slave. This **OR** function of alarms among the devices can be used, for example, for a "maximum temperature setpoint" alarm in each zone to be heated by appropriately configuring the "Ax.t" parameters.

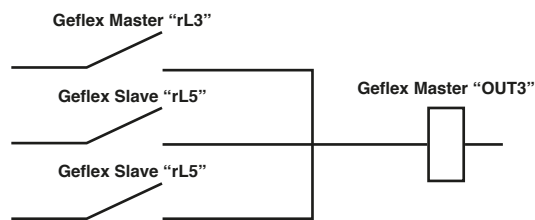

Output "OUT3" can function independently of the state of the Geflex Slaves by setting parameter "rL5" to 128 on each Geflex Slave.

- The "OUT4" relay can be energized only with the simultaneous presence of the "rL4" command of the Geflex Master and commands "rL6" of all the Geflex Slave. This **AND** of alarms among the devices can be used, for example, to signal "minimum temperature setpoint reached" in each zone to be heated by appropriately configuring the "Ax.t" parameters.



Output "OUT4" can operate independently of the state of the Geflex Slaves by setting parameter "rL6" to 160 (128+32) on each Geflex Slave.

1.7.1 Output control with Solid Power State module or "R" module

Settings

191 **hd.1** R/W Enabling multiset instrument management via serial

hd.1	Enabling Multiset	Enabling instrument via serial	If "GTS-L or R" module is present	If "RR" module is present	If "CC" module is present	If "V" module is present
0			X			
1	X		X			
2		X	X			
3	X	X	X			
4				X		
5	X			X		
6		X		X		
7	X	X		X		
8					X	
9	X				X	
10		X			X	
11	X	X			X	
16						X
17						X
18						X
19						X

0

If module "CC" or "RR" present see rL.1 parameter for Out1 and Out7 impostation.
 If module "V" present Out1 = open, Out7 = closed.
 +32 if Out2 = "C" (continuous).
 +64 output 1 function attributed to output 7, Out1 = OFF

160 **rL.1** R/W Out 1 Allocation of reference signal

163 **rL.2** R/W Out 2 Allocation of reference signal

+ 32 for inverse logic signal output
 + 128 to force output to zero
 (not valid for continuous OUT2 and for 64 and 65 function)

Val	Function
0	HEAT (control output for heating) / in case of continuous OUT 2 output 0...20mA / 0...10V
1	COOL (control output for cooling) / in case of continuous OUT 2 output 0...20mA / 0...10V
2	AL1 - alarm 1
3	AL2 - alarm 2
4	AL3 - alarm 3
5	AL.HB - alarm HB (TA1)
6	LBA - alarm LBA
7	IN - repetition of logic input
8	AL4 - alarm 4
9	AL1 or AL2
10	AL1 or AL2 or AL3
11	AL1 or AL2 or AL3 or AL4
12	AL1 and AL2
13	AL1 and AL2 and AL3
14	AL1 and AL2 and AL3 and AL4
15	AL1 or ALHB
16	AL1 or AL2 or ALHB (TA1)
17	AL1 and ALHB
18	AL1 and AL2 and ALHB (TA1)
19	AL.HB - alarm HB (TA2)
20	AL.HB - alarm HB (TA3)
21	Setpoint power alarm
64	HEAT (heat control output) with fast cycle time 0.1 ... 20.0sec. / in case of continuous OUT 2 output 4...20mA / 2...10V
65	COOL (cool control output) with fast cycle time 0.1 ... 20.0sec. / in case of continuous OUT 2 output 4...20mA / 2...10V

0

1

166 **rL.3** R/W Out 3 Allocation of reference signal

170 **rL.4** R/W Out 4 Allocation of reference signal

171 **rL.5** R/W Out 5 Allocation of reference signal

172 **rL.6** R/W Out 6 Allocation of reference signal

Val	Function
0	copies state of output rL.1 **
1	copies state of output rL.2 **
2	AL1 - alarm 1
3	AL2 - alarm 2
4	AL3 - alarm 3
5	AL.HB - alarm HB (TA1)
6	LBA - alarm LBA
7	IN - repetition of logic input
8	AL4 - alarm 4
9	AL1 or AL2
10	AL1 or AL2 or AL3
11	AL1 or AL2 or AL3 or AL4
12	AL1 and AL2
13	AL1 and AL2 and AL3
14	AL1 and AL2 and AL3 and AL4
15	AL1 or ALHB
16	AL1 or AL2 or ALHB (TA1)
17	AL1 and ALHB
18	AL1 and AL2 and ALHB (TA1)
19	AL.HB - alarm HB (TA2)
20	AL.HB - alarm HB (TA3)
21	Setpoint power alarm

2

3

4

5

+ 32 for inverse logic signal output
 + 128 to force output to zero

** NB.:
 for rL.3 / rL.4 only, copies state of output rL.1 or rL.2 i.e., replicates ON or OFF state of configured output.
 On the Geflex Master, if single, output rL.4 always replicates the state of rL.1 or rL.2 whereas if a slave is present, output rL.4 (being in AND) does not replicate the state.

Status

319	- - -	R	State of MASKOUT logic/relay outputs
bit. 12	- - -	R	OUT1 status
bit. 13	- - -	R	OUT2 status
bit. 14	- - -	R	OUT3 status
bit. 15	- - -	R	OUT4 status
bit. 16	- - -	R	OUT5 status
bit. 17	- - -	R	OUT6 status

bit. 0 = OUT1 ... bit. 5 = OUT6

bit	Status
bit. 0	OUT1
bit. 1	OUT2
bit. 2	OUT3
bit. 3	OUT4
bit. 4	OUT5
bit. 5	OUT6

1.8 AL.1/2/3/4 alarms

Four generic alarms are always available and can take on various functions. Typically, alarm AL.1 is defined as minimum and AL.2 as maximum.

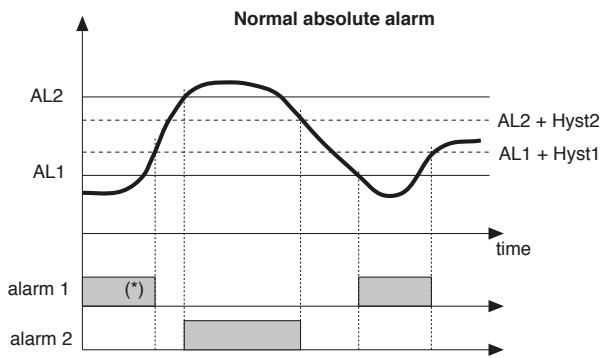

For AL1 = reverse absolute alarm (low) with positive Hyst1, AL1 t = 1
 (*) = OFF if disabled on power-up
 For AL2 = direct absolute alarm (high) with negative Hyst2, AL2 t = 0

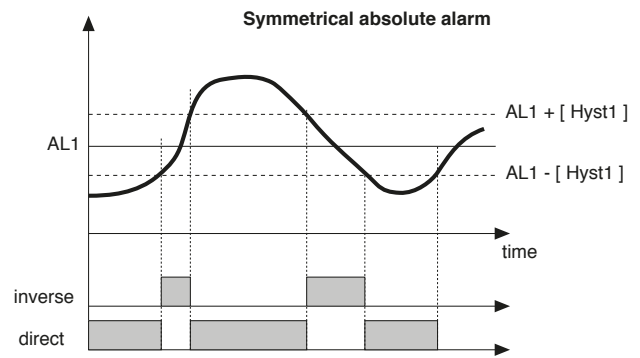

For AL1 = symmetrical Lo absolute alarm with Hyst1, AL1 t = 5
 For AL1 = symmetrical Hi absolute alarm with Hyst1, AL1 t = 4

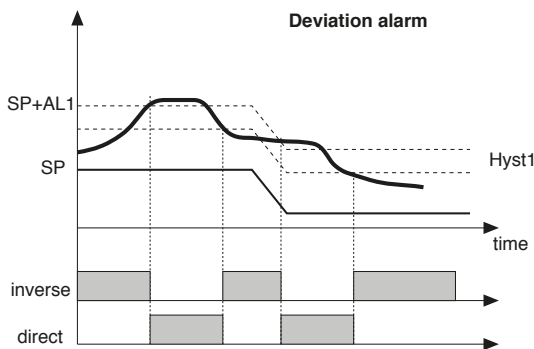

For AL1 = Lo deviation alarm with negative Hyst 1, AL1 t = 3
 For AL1 = Hi deviation alarm with negative Hyst 1, AL1 t = 2

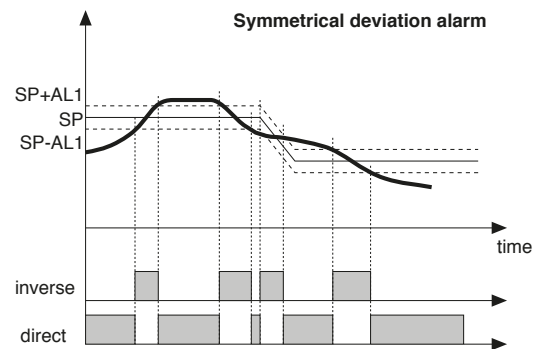

For AL1 = Symmetrical Lo deviation alarm with Hyst 1, AL1 t = 7
 For AL1 = Symmetrical Hi deviation alarm with Hyst 1, AL1 t = 6

Enable alarms

195	ALn	R/W	Select number of enabled alarms		1
-----	-----	-----	---------------------------------	--	---

AL.nr	Alarm 1	Alarm 2	Alarm 3	Alarm 4
0	disabled	disabled	disabled	disabled
1	enabled	disabled	disabled	disabled
2	disabled	enabled	disabled	disabled
3	enabled	enabled	disabled	disabled
4	disabled	disabled	enabled	disabled
5	enabled	disabled	enabled	disabled
6	disabled	enabled	enabled	disabled
7	enabled	enabled	enabled	disabled
8	disabled	disabled	disabled	enabled
9	enabled	disabled	disabled	enabled
10	disabled	enabled	disabled	enabled
11	enabled	enabled	disabled	enabled
12	disabled	disabled	enabled	enabled
13	enabled	disabled	enabled	enabled
14	disabled	enabled	enabled	enabled
15	enabled	enabled	enabled	enabled

+ 16 to enable HB alarm
 + 32 to enable LBA alarm

Alarm setpoint

12 475 - 177	AL.1	R/W	Alarm point 1 (scale points)	Lo.L ... Hi.L	500
13 476 - 178	AL.2	R/W	Alarm point 2 (scale points)	Lo.L ... Hi.L	600
14 52 - 479	AL.3	R/W	Alarm point 3 (scale points)	Lo.L ... Hi.L	700
58 480	AL.4	R/W	Alarm point 4 (scale points)	Lo.L ... Hi.L	800

Limits

25 20 - 28 - 142	LoL	R/W	Lower limit for local setpoint and absolute alarms	Lo.S ... Hi.S	0
26 21 - 29 - 143	HiL	R/W	Upper limit for local setpoint and absolute alarms	Lo.S ... Hi.S	1000

Reference signal for comparison

215	A1r	R/W	Select reference signal for alarm 1	<table border="1"> <thead> <tr> <th>AL.x.r</th> <th>Variable to compare</th> <th>Alarm setpoint</th> </tr> </thead> <tbody> <tr> <td>0</td> <td>PV (process variable)</td> <td>AL</td> </tr> <tr> <td>1</td> <td>I.tA1 OR I.tA2 OR I.tA3, or Auxiliary input</td> <td>AL</td> </tr> <tr> <td>2</td> <td>I.tV1 OR I.tV2 OR I.tV3,</td> <td>AL</td> </tr> <tr> <td>3</td> <td>SSP (active setpoint)</td> <td>AL (only absolute)</td> </tr> <tr> <td>4</td> <td>PV (process variable)</td> <td>AL [only deviation and referred to SP1 (with multiset function)]</td> </tr> </tbody> </table>	AL.x.r	Variable to compare	Alarm setpoint	0	PV (process variable)	AL	1	I.tA1 OR I.tA2 OR I.tA3, or Auxiliary input	AL	2	I.tV1 OR I.tV2 OR I.tV3,	AL	3	SSP (active setpoint)	AL (only absolute)	4	PV (process variable)	AL [only deviation and referred to SP1 (with multiset function)]	0
AL.x.r	Variable to compare	Alarm setpoint																					
0	PV (process variable)	AL																					
1	I.tA1 OR I.tA2 OR I.tA3, or Auxiliary input	AL																					
2	I.tV1 OR I.tV2 OR I.tV3,	AL																					
3	SSP (active setpoint)	AL (only absolute)																					
4	PV (process variable)	AL [only deviation and referred to SP1 (with multiset function)]																					
216	A2r	R/W	Select reference signal for alarm 2																				
217	A3r	R/W	Select reference signal for alarm 3																				
218	A4r	R/W	Select reference signal for alarm 4																				

N.B.:
For codes 1 and 2, the alarm reference is in scale points and not to the decimal point (d.P)

Alarm behavior

406	A1t	R/W	Alarm type 1	<table border="1"> <thead> <tr> <th>AL.x.t</th> <th>Direct (high limit) Inverse (low limit)</th> <th>Absolute Relative to active setpoint</th> <th>Normal Symmetric (window)</th> </tr> </thead> <tbody> <tr><td>0</td><td>direct</td><td>absolute</td><td>normal</td></tr> <tr><td>1</td><td>inverse</td><td>absolute</td><td>normal</td></tr> <tr><td>2</td><td>direct</td><td>relative</td><td>normal</td></tr> <tr><td>3</td><td>inverse</td><td>relative</td><td>normal</td></tr> <tr><td>4</td><td>direct</td><td>absolute</td><td>symmetric</td></tr> <tr><td>5</td><td>inverse</td><td>absolute</td><td>symmetric</td></tr> <tr><td>6</td><td>direct</td><td>relative</td><td>symmetric</td></tr> <tr><td>7</td><td>inverse</td><td>relative</td><td>symmetric</td></tr> </tbody> </table>	AL.x.t	Direct (high limit) Inverse (low limit)	Absolute Relative to active setpoint	Normal Symmetric (window)	0	direct	absolute	normal	1	inverse	absolute	normal	2	direct	relative	normal	3	inverse	relative	normal	4	direct	absolute	symmetric	5	inverse	absolute	symmetric	6	direct	relative	symmetric	7	inverse	relative	symmetric	0				
AL.x.t	Direct (high limit) Inverse (low limit)	Absolute Relative to active setpoint	Normal Symmetric (window)																																										
0	direct	absolute	normal																																										
1	inverse	absolute	normal																																										
2	direct	relative	normal																																										
3	inverse	relative	normal																																										
4	direct	absolute	symmetric																																										
5	inverse	absolute	symmetric																																										
6	direct	relative	symmetric																																										
7	inverse	relative	symmetric																																										
407	A2t	R/W	Alarm type 2																																										
408	A3t	R/W	Alarm type 3																																										
409	A4t	R/W	Alarm type 4																																										
<p>+ 8 to disable on power up until first interception + 16 to latch alarm + 32 Hys becomes alarm activation delay time (0..999 sec.) (excluding absolute symmetric) + 64 Hys becomes alarm activation delay time (0..999 sec.) (excluding absolute symmetric) + 136 to disable on power up or on the change of the setpoint until first interception</p>																																													
<table border="1"> <thead> <tr> <th></th> <th>AL1</th> <th>AL2</th> <th>AL3</th> <th>AL4</th> <th></th> <th></th> </tr> </thead> <tbody> <tr> <td>bit</td> <td>46</td> <td>54</td> <td>36</td> <td>70</td> <td>R/W</td> <td>Direct/Invers</td> </tr> <tr> <td></td> <td>47</td> <td>55</td> <td>37</td> <td>71</td> <td>R/W</td> <td>Absolute/Relative</td> </tr> <tr> <td></td> <td>48</td> <td>56</td> <td>38</td> <td>72</td> <td>R/W</td> <td>Normal/Symmetric</td> </tr> <tr> <td></td> <td>49</td> <td>57</td> <td>39</td> <td>73</td> <td>R/W</td> <td>Disabled at power-up</td> </tr> <tr> <td></td> <td>50</td> <td>58</td> <td>40</td> <td>74</td> <td>R/W</td> <td>With memory</td> </tr> </tbody> </table>					AL1	AL2	AL3	AL4			bit	46	54	36	70	R/W	Direct/Invers		47	55	37	71	R/W	Absolute/Relative		48	56	38	72	R/W	Normal/Symmetric		49	57	39	73	R/W	Disabled at power-up		50	58	40	74	R/W	With memory
	AL1	AL2	AL3	AL4																																									
bit	46	54	36	70	R/W	Direct/Invers																																							
	47	55	37	71	R/W	Absolute/Relative																																							
	48	56	38	72	R/W	Normal/Symmetric																																							
	49	57	39	73	R/W	Disabled at power-up																																							
	50	58	40	74	R/W	With memory																																							

Alarm hysteresis

27 187	H4.1	R/W	Alarm 1 hysteresis	±999 scale points	0..999 sec. Se +32 in A1.t 0..999 min. Se +64 in A1.t	-1
30 188	H4.2	R/W	Alarm 2 hysteresis	±999 scale points	0..999 sec. Se +32 in A2.t 0..999 min. Se +64 in A2.t	-1
53 189	H4.3	R/W	Alarm 3 hysteresis	±999 scale points	0..999 sec. Se +32 in A3.t 0..999 min. Se +64 in A3.t	-1
59	H4.4	R/W	Alarm 4 hysteresis	±999 scale points	0..999 sec. Se +32 in A4.t 0..999 min. Se +64 in A4.t	-1

Allocation of outputs for alarms

160	rL.1	R/W	Out 1 Allocation of reference signal
163	rL.2	R/W	Out 2 Allocation of reference signal

Val	Function
0	HEAT (control output for heating) / in case of continuous OUT 2 output 0...20mA / 0...10V
1	COOL (control output for cooling) / in case of continuous OUT 2 output 0...20mA / 0...10V
2	AL1 - alarm 1
3	AL2 - alarm 2
4	AL3 - alarm 3
5	AL.HB - alarm HB (TA1)
6	LBA - alarm LBA
7	IN - repetition of logic input
8	AL4 - alarm 4
9	AL1 or AL2
10	AL1 or AL2 or AL3
11	AL1 or AL2 or AL3 or AL4
12	AL1 and AL2
13	AL1 and AL2 and AL3
14	AL1 and AL2 and AL3 and AL4
15	AL1 or ALHB
16	AL1 or AL2 or ALHB (TA1)
17	AL1 and ALHB
18	AL1 and AL2 and ALHB (TA1)
19	AL.HB - alarm HB (TA2)
20	AL.HB - alarm HB (TA3)
21	Setpoint power alarm
64	HEAT (heat control output) with fast cycle time 0.1 ... 20.0sec. / in case of continuous OUT 2 output 4...20mA / 2...10V
65	COOL (cool control output) with fast cycle time 0.1 ... 20.0sec. / in case of continuous OUT 2 output 4...20mA / 2...10V

0

1

+ 32 for inverse logic signal output
+ 128 to force output to zero
(not valid for continuous OUT2 and for 64 and 65 function)

166	rL.3	R/W	Out 3 Allocation of reference signal
170	rL.4	R/W	Out 4 Allocation of reference signal
171	rL.5	R/W	Out 5 Allocation of reference signal
172	rL.6	R/W	Out 6 Allocation of reference signal

Val	Function
0	copies state of output rL.1 **
1	copies state of output rL.2 **
2	AL1 - alarm 1
3	AL2 - alarm 2
4	AL3 - alarm 3
5	AL.HB - alarm HB (TA1)
6	LBA - alarm LBA
7	IN - repetition of logic input
8	AL4 - alarm 4
9	AL1 or AL2
10	AL1 or AL2 or AL3
11	AL1 or AL2 or AL3 or AL4
12	AL1 and AL2
13	AL1 and AL2 and AL3
14	AL1 and AL2 and AL3 and AL4
15	AL1 or ALHB
16	AL1 or AL2 or ALHB (TA1)
17	AL1 and ALHB
18	AL1 and AL2 and ALHB (TA1)
19	AL.HB - alarm HB (TA2)
20	AL.HB - alarm HB (TA3)
21	Setpoint power alarm

2

3

4

5

+ 32 for inverse logic signal output
+ 128 to force output to zero

** NB.:
for rL.3 / rL.4 only, copies state of output rL.i or rL.2 i.e., replicates ON or OFF state of configured output..

On the Geflex Master, if single, output rL.4 always replicates the state of rL.i or rL.2 whereas if a slave is present, output rL.4 (being in AND) does not replicate the state.

140	d iG.	R/W	Function of digital input
-----	-------	-----	------------------------------

0	none (key disabled)
1	MAN / AUTO controller
2	LOC / REM
3	HOLD
4	Reset alarms memory
5	SP1/SP2 selection
6	Software On/Off switching function
7	None
8	START / STOP Selftuning
9	START / STOP Autotuning

0

+ 16 for inverse logic input
+ 32 to force logic state 0 (OFF)
+ 48 to force logic state 1 (ON)

Status

bit. 68	- - -	R	Digital input status
------------	-------	---	----------------------

318	- - -	R	AL STATE_IRQ
-----	-------	---	--------------

bit	
0	AL1
1	AL2
2	AL3
3	AL4
4	AL.HB

469	- - -	R	Instrument 1 status
-----	-------	---	---------------------

bit	
0	AL1 or AL2 or AL3 or AL4 or ALHB.TA1, ALHB.TA2, ALHB.TA3
1	input Lo
2	input Hi
3	input Err
4	input Sbr
5	-
6	-
7	LBA
8	AL1
9	AL2
10	AL3
11	AL4
12	ALHB.TA1
13	ALHB.TA2
14	ALHB.TA3
15	Self-tuning active

bit. 4	- - -	R	AL1 status
-----------	-------	---	------------

bit. 5	- - -	R	AL2status
-----------	-------	---	-----------

bit. 62	- - -	R	AL3 status
------------	-------	---	------------

bit. 69	- - -	R	AL4 status
------------	-------	---	------------

1.9 LBA alarm (Loop Break Alarm)

This alarm identifies interruption of the control loop due to a possible probe in short circuit, inverted probe or interrupted load. If enabled (AL.nr) generates an alarm in case the value of the variable doesn't rise in heating (doesn't drop in cooling) under conditions of maximum power supplied for a settable time (LbA.t).

The value of the variable is enabled only outside the proportional band; for active alarm, power is limited to the value (LbA.P).

The alarm condition resets if the temperature rises in heating (drops in cooling). By setting parameter LbA.t = 0, function LBA is disabled.

Settings

195 **AL.nr** R/W Select number of enabled alarms

AL.nr	Alarm 1	Alarm 2	Alarm 3	Alarm 4
0	disabled	disabled	disabled	disabled
1	enabled	disabled	disabled	disabled
2	disabled	enabled	disabled	disabled
3	enabled	enabled	disabled	disabled
4	disabled	disabled	enabled	disabled
5	enabled	disabled	enabled	disabled
6	disabled	enabled	enabled	disabled
7	enabled	enabled	enabled	disabled
8	disabled	disabled	disabled	enabled
9	enabled	disabled	disabled	enabled
10	disabled	enabled	disabled	enabled
11	enabled	enabled	disabled	enabled
12	disabled	disabled	enabled	enabled
13	enabled	disabled	enabled	enabled
14	disabled	enabled	enabled	enabled
15	enabled	enabled	enabled	enabled

1

+ 16 to enable HB alarm
+ 32 to enable LBA alarm

44 **Lb.t** R/W Waiting time for LBA alarm intervention (set to "0" to disable LBA alarm) 0.0 ... 500.0 min 30,0

119 **Lb.P** R/W Power limit for LBA alarm condition -100.0 ... 100.0% 25,0

160 **rL.1** R/W Out 1 Allocation of reference signal

163 **rL.2** R/W Out 2 Allocation of reference signal

+ 32 for inverse logic signal output
+ 128 to force output to zero
(not valid for continuous OUT2 and for 64 and 65 function)

Val	Function
0	HEAT (control output for heating) / in case of continuous OUT 2 output 0...20mA / 0...10V
1	COOL (control output for cooling) / in case of continuous OUT 2 output 0...20mA / 0...10V
2	AL1 - alarm 1
3	AL2 - alarm 2
4	AL3 - alarm 3
5	AL.HB - alarm HB (TA1)
6	LBA - alarm LBA
7	IN - repetition of logic input
8	AL4 - alarm 4
9	AL1 or AL2
10	AL1 or AL2 or AL3
11	AL1 or AL2 or AL3 or AL4
12	AL1 and AL2
13	AL1 and AL2 and AL3
14	AL1 and AL2 and AL3 and AL4
15	AL1 or ALHB
16	AL1 or AL2 or ALHB (TA1)
17	AL1 and ALHB
18	AL1 and AL2 and ALHB (TA1)
19	AL.HB - alarm HB (TA2)
20	AL.HB - alarm HB (TA3)
21	Setpoint power alarm
64	HEAT (heat control output) with fast cycle time 0.1 ... 20.0sec. / in case of continuous OUT 2 output 4...20mA / 2...10V
65	COOL (cool control output) with fast cycle time 0.1 ... 20.0sec. / in case of continuous OUT 2 output 4...20mA / 2...10V

0

1

166 **rL.3** R/W Out 3 Allocation of reference signal

170 **rL.4** R/W Out 4 Allocation of reference signal

171 **rL.5** R/W Out 5 Allocation of reference signal

172 **rL.6** R/W Out 6 Allocation of reference signal

Val	Function
0	copies state of output rL.1 **
1	copies state of output rL.2 **
2	AL1 - alarm 1
3	AL2 - alarm 2
4	AL3 - alarm 3
5	AL.HB - alarm HB (TA1)
6	LBA - alarm LBA
7	IN - repetition of logic input
8	AL4 - alarm 4
9	AL1 or AL2
10	AL1 or AL2 or AL3
11	AL1 or AL2 or AL3 or AL4
12	AL1 and AL2
13	AL1 and AL2 and AL3
14	AL1 and AL2 and AL3 and AL4
15	AL1 or ALHB
16	AL1 or AL2 or ALHB (TA1)
17	AL1 and ALHB
18	AL1 and AL2 and ALHB (TA1)
19	AL.HB - alarm HB (TA2)
20	AL.HB - alarm HB (TA3)
21	Setpoint power alarm

2

3

4

5

+ 32 for inverse logic signal output
+ 128 to force output to zero

** NB.:
for rL.3 / rL.4 only, copies state of output rL.i or rL.2 i.e., replicates ON or OFF state of configured output..

On the Geflex Master, if single, output rL.4 always replicates the state of rL.i or rL.2 whereas if a slave is present, output rL.4 (being in AND) does not replicate the state.

Status

469	- - -	R	Status Strumento 1
-----	-------	---	--------------------

bit. 8	- - -	R	LBA alarm status
-----------	-------	---	------------------

bit	
0	AL1 or AL2 or AL3 or AL4 or ALHB.TA1, ALHB.TA2, ALHB.TA3
1	input Lo
2	input Hi
3	input Err
4	input Sbr
5	-
6	-
7	LBA
8	AL1
9	AL2
10	AL3
11	AL4
12	ALHB.TA1
13	ALHB.TA2
14	ALHB.TA3
15	Self-tuning active

1.10 HB alarm (Heater Break)

Set for models with diagnostics options CO, CV.

In order to function, this alarm requires the presence of an (internal or external) current transformer. It signals load absorption changes by discriminating the current value in current input in the range (0 ... **HS.tAx**). It is enabled with configuration code (AL.n); in this case, the alarm trip value is expressed in HB scale points.

The alarm function and the assigned control output OUT1 are selected through parameter **Hb.F** ("Out" phase).

The alarm setpoint is **A.Hb.tAx**.

The direct HB alarm trips if current transformer input falls below the setpoint for **Hb.t** seconds of "ON" time for the selected output.

The HB alarm may trip only with ON times exceeding 0.4 seconds.

When the voltmeter input option is present, the alarm is cancelled for voltage values below 1/4 of full scale.

The HB alarm monitors load current even during the OFF period of the cycle time of the selected output. The HB alarm will trip if measured current exceeds 12.5% of the assigned full scale (parameter **HS.tAx**) for Hb.t seconds when the output is in OFF state.

The alarm is reset automatically when alarm conditions have been cleared.

If **A.Hb.tAx** is set = 0, both types of HB alarm are disabled and the assigned relay is de-energized.

The current value is available in the In.tAx register.

NOTE: ON/OFF times refer to the cycle time set for the selected output.

Alarm Hb_F = 3 (7), for analog output is ON when the load current is lower than the alarm setpoint; the alarm is disabled if the heating (cooling) output is lower than 3%.

This alarm does not make reference to the cycle time.

Settings

195 **ALn** R/W Select number of enabled alarms 1

AL.nr	Alarm 1	Alarm 2	Alarm 3	Alarm 4
0	disabled	disabled	disabled	disabled
1	enabled	disabled	disabled	disabled
2	disabled	enabled	disabled	disabled
3	enabled	enabled	disabled	disabled
4	disabled	disabled	enabled	disabled
5	enabled	disabled	enabled	disabled
6	disabled	enabled	enabled	disabled
7	enabled	enabled	enabled	disabled
8	disabled	disabled	disabled	enabled
9	enabled	disabled	disabled	enabled
10	disabled	enabled	disabled	enabled
11	enabled	enabled	disabled	enabled
12	disabled	disabled	enabled	enabled
13	enabled	disabled	enabled	enabled
14	disabled	enabled	enabled	enabled
15	enabled	enabled	enabled	enabled

+ 16 to enable HB alarm
+ 32 to enable LBA alarm

57 **Hb.F** R/W HB alarm function 0

Val.	Function description
0	Relay, logic output: alarm active on load current level lower than setpoint during the ON time of the control output
1	Relay, logic output: alarm active on load current level higher than setpoint during the OFF time of the control output
2	Alarm active if one of functions 0 and 1 is true (OR logic between 0 and 1) (*)
3	Continuous for heating
7	Continuous for cooling

Default:
single reference alarm (A.Hb.1) and OR between phases 1, 2 and 3.
+ 8 inverse HB alarm
+ 16 relative to single alarms and single phases

(*) minimum setting is fixed at 12 % of amperometric full scale

474 55 **A.Hb.1** R/W Alarm trip point HB (current input scale points) (Phase 1) 10,0

502 **A.Hb.2** R/W Alarm trip point HB (current input scale points) (Phase 2) 10,0

503 **A.Hb.3** R/W Alarm trip point HB (current input scale points) (Phase 3) 10,0

56 **Hb.t** R/W Waiting time for HB alarm intervention 0 ... 999 sec (value has to be higher than cycle time value of output to which HB alarm is assigned) 30

160	rL.1	R/W	Out 1 Allocation of reference signal
163	rL.2	R/W	Out 2 Allocation of reference signal

+ 32 for inverse logic signal output
+ 128 to force output to zero
(not valid for continuous OUT2 and for
64 and 65 function)

Val	Function
0	HEAT (control output for heating) / in case of continuous OUT 2 output 0...20mA / 0...10V
1	COOL (control output for cooling) / in case of continuous OUT 2 output 0...20mA / 0...10V
2	AL1 - alarm 1
3	AL2 - alarm 2
4	AL3 - alarm 3
5	AL.HB - alarm HB (TA1)
6	LBA - alarm LBA
7	IN - repetition of logic input
8	AL4 - alarm 4
9	AL1 or AL2
10	AL1 or AL2 or AL3
11	AL1 or AL2 or AL3 or AL4
12	AL1 and AL2
13	AL1 and AL2 and AL3
14	AL1 and AL2 and AL3 and AL4
15	AL1 or ALHB
16	AL1 or AL2 or ALHB (TA1)
17	AL1 and ALHB
18	AL1 and AL2 and ALHB (TA1)
19	AL.HB - alarm HB (TA2)
20	AL.HB - alarm HB (TA3)
21	Setpoint power alarm
64	HEAT (heat control output) with fast cycle time 0.1 ... 20.0sec. / in case of continuous OUT 2 output 4...20mA / 2...10V
65	COOL (cool control output) with fast cycle time 0.1 ... 20.0sec. / in case of continuous OUT 2 output 4...20mA / 2...10V

0
1

166	rL.3	R/W	Out 3 Allocation of reference signal
170	rL.4	R/W	Out 4 Allocation of reference signal
171	rL.5	R/W	Out 5 Allocation of reference signal
172	rL.6	R/W	Out 6 Allocation of reference signal

+ 32 for inverse logic signal output
+ 128 to force output to zero

Val	Function
0	copies state of output rL.1 **
1	copies state of output rL.2 **
2	AL1 - alarm 1
3	AL2 - alarm 2
4	AL3 - alarm 3
5	AL.HB - alarm HB (TA1)
6	LBA - alarm LBA
7	IN - repetition of logic input
8	AL4 - alarm 4
9	AL1 or AL2
10	AL1 or AL2 or AL3
11	AL1 or AL2 or AL3 or AL4
12	AL1 and AL2
13	AL1 and AL2 and AL3
14	AL1 and AL2 and AL3 and AL4
15	AL1 or ALHB
16	AL1 or AL2 or ALHB (TA1)
17	AL1 and ALHB
18	AL1 and AL2 and ALHB (TA1)
19	AL.HB - alarm HB (TA2)
20	AL.HB - alarm HB (TA3)
21	Setpoint power alarm

2
3
4
5

** NB.:
for rL.3 / rL.4 only, copies state of output rL.1 or rL.2 i.e., replicates ON or OFF state of
configured output.

On the Geflex Master, if single, output rL.4 always replicates the state of rL.1 or rL.2
whereas if a slave is present, output rL.4 (being in AND) does not replicate the state.

Status

512	- - -	R	ALSTATE alarms status	bit.4 HB alarm ON time bit.5 HB alarm OFF time bit.6 HB alarm
-----	-------	---	-----------------------	---

469	- - -	R	Instrument 1 status	<table border="1"> <thead> <tr><th>bit</th><th></th></tr> </thead> <tbody> <tr><td>0</td><td>AL1 or AL2 or AL3 or AL4 or ALHB.TA1, ALHB.TA2, ALHB.TA3</td></tr> <tr><td>1</td><td>input Lo</td></tr> <tr><td>2</td><td>input Hi</td></tr> <tr><td>3</td><td>input Err</td></tr> <tr><td>4</td><td>input Sbr</td></tr> <tr><td>5</td><td>-</td></tr> <tr><td>6</td><td>-</td></tr> <tr><td>7</td><td>LBA</td></tr> <tr><td>8</td><td>AL1</td></tr> <tr><td>9</td><td>AL2</td></tr> <tr><td>10</td><td>AL3</td></tr> <tr><td>11</td><td>AL4</td></tr> <tr><td>12</td><td>ALHB.TA1</td></tr> <tr><td>13</td><td>ALHB.TA2</td></tr> <tr><td>14</td><td>ALHB.TA3</td></tr> <tr><td>15</td><td>Self-tuning active</td></tr> </tbody> </table>	bit		0	AL1 or AL2 or AL3 or AL4 or ALHB.TA1, ALHB.TA2, ALHB.TA3	1	input Lo	2	input Hi	3	input Err	4	input Sbr	5	-	6	-	7	LBA	8	AL1	9	AL2	10	AL3	11	AL4	12	ALHB.TA1	13	ALHB.TA2	14	ALHB.TA3	15	Self-tuning active
bit																																						
0	AL1 or AL2 or AL3 or AL4 or ALHB.TA1, ALHB.TA2, ALHB.TA3																																					
1	input Lo																																					
2	input Hi																																					
3	input Err																																					
4	input Sbr																																					
5	-																																					
6	-																																					
7	LBA																																					
8	AL1																																					
9	AL2																																					
10	AL3																																					
11	AL4																																					
12	ALHB.TA1																																					
13	ALHB.TA2																																					
14	ALHB.TA3																																					
15	Self-tuning active																																					

bit. 76	- - -	R	HB alarm status (CT fase 1)
---------	-------	---	--------------------------------

bit. 77	- - -	R	HB alarm status (CT fase 2)
---------	-------	---	--------------------------------

bit. 78	- - -	R	HB alarm status (CT fase 3)
---------	-------	---	--------------------------------

bit. 26	- - -	R	HB alarm status (OR TA1-TA2-TA3)
---------	-------	---	-------------------------------------

318	- - -	R	AL STATE_IRQ	<table border="1"> <thead> <tr><th>bit</th><th></th></tr> </thead> <tbody> <tr><td>0</td><td>AL1</td></tr> <tr><td>1</td><td>AL2</td></tr> <tr><td>2</td><td>AL3</td></tr> <tr><td>3</td><td>AL4</td></tr> <tr><td>4</td><td>AL.HB</td></tr> </tbody> </table>	bit		0	AL1	1	AL2	2	AL3	3	AL4	4	AL.HB
bit																
0	AL1															
1	AL2															
2	AL3															
3	AL4															
4	AL.HB															

1.11 Alarm due to probe in short or wrong connection (SBR-ERR)

This alarm is always active and cannot be deactivated. It controls correct functioning of the probe connected to the main input.

Settings

229	rEL	R/W	Fault action (sets state in case of probe fault) Err, Sbr	<table border="1"> <thead> <tr> <th>rEL.</th> <th>Alarm 1</th> <th>Alarm 2</th> <th>Alarm 3</th> <th>Alarm 4</th> </tr> </thead> <tbody> <tr><td>0</td><td>OFF</td><td>OFF</td><td>OFF</td><td>OFF</td></tr> <tr><td>1</td><td>ON</td><td>OFF</td><td>OFF</td><td>OFF</td></tr> <tr><td>2</td><td>OFF</td><td>ON</td><td>OFF</td><td>OFF</td></tr> <tr><td>3</td><td>ON</td><td>ON</td><td>OFF</td><td>OFF</td></tr> <tr><td>4</td><td>OFF</td><td>OFF</td><td>ON</td><td>OFF</td></tr> <tr><td>5</td><td>ON</td><td>OFF</td><td>ON</td><td>OFF</td></tr> <tr><td>6</td><td>OFF</td><td>ON</td><td>ON</td><td>OFF</td></tr> <tr><td>7</td><td>ON</td><td>ON</td><td>ON</td><td>OFF</td></tr> <tr><td>8</td><td>OFF</td><td>OFF</td><td>OFF</td><td>ON</td></tr> <tr><td>9</td><td>ON</td><td>OFF</td><td>OFF</td><td>ON</td></tr> <tr><td>10</td><td>OFF</td><td>ON</td><td>OFF</td><td>ON</td></tr> <tr><td>11</td><td>ON</td><td>ON</td><td>OFF</td><td>ON</td></tr> <tr><td>12</td><td>OFF</td><td>OFF</td><td>ON</td><td>ON</td></tr> <tr><td>13</td><td>ON</td><td>OFF</td><td>ON</td><td>ON</td></tr> <tr><td>14</td><td>OFF</td><td>ON</td><td>ON</td><td>ON</td></tr> <tr><td>15</td><td>ON</td><td>ON</td><td>ON</td><td>ON</td></tr> </tbody> </table>	rEL.	Alarm 1	Alarm 2	Alarm 3	Alarm 4	0	OFF	OFF	OFF	OFF	1	ON	OFF	OFF	OFF	2	OFF	ON	OFF	OFF	3	ON	ON	OFF	OFF	4	OFF	OFF	ON	OFF	5	ON	OFF	ON	OFF	6	OFF	ON	ON	OFF	7	ON	ON	ON	OFF	8	OFF	OFF	OFF	ON	9	ON	OFF	OFF	ON	10	OFF	ON	OFF	ON	11	ON	ON	OFF	ON	12	OFF	OFF	ON	ON	13	ON	OFF	ON	ON	14	OFF	ON	ON	ON	15	ON	ON	ON	ON	0
rEL.	Alarm 1	Alarm 2	Alarm 3	Alarm 4																																																																																						
0	OFF	OFF	OFF	OFF																																																																																						
1	ON	OFF	OFF	OFF																																																																																						
2	OFF	ON	OFF	OFF																																																																																						
3	ON	ON	OFF	OFF																																																																																						
4	OFF	OFF	ON	OFF																																																																																						
5	ON	OFF	ON	OFF																																																																																						
6	OFF	ON	ON	OFF																																																																																						
7	ON	ON	ON	OFF																																																																																						
8	OFF	OFF	OFF	ON																																																																																						
9	ON	OFF	OFF	ON																																																																																						
10	OFF	ON	OFF	ON																																																																																						
11	ON	ON	OFF	ON																																																																																						
12	OFF	OFF	ON	ON																																																																																						
13	ON	OFF	ON	ON																																																																																						
14	OFF	ON	ON	ON																																																																																						
15	ON	ON	ON	ON																																																																																						
228	FAP	R/W	Power output in fault condition (when probe is faulty)	-100.0 ... 100.0% ON / OFF	0,0																																																																																					

Status

85	Err	R	Self diagnostic error code	<table border="1"> <tr><td>0</td><td>No Error</td></tr> <tr><td>1</td><td>Lo (process variable value is < than Lo.S)</td></tr> <tr><td>2</td><td>Hi (process variable value is > than Hi.S)</td></tr> <tr><td>3</td><td>ERR [third wire broken for PT100 or input values below minimum limits (ex. for CT with wrong connection)]</td></tr> <tr><td>4</td><td>SBR (broken probe or input values above maximum limits)</td></tr> </table>	0	No Error	1	Lo (process variable value is < than Lo.S)	2	Hi (process variable value is > than Hi.S)	3	ERR [third wire broken for PT100 or input values below minimum limits (ex. for CT with wrong connection)]	4	SBR (broken probe or input values above maximum limits)
0	No Error													
1	Lo (process variable value is < than Lo.S)													
2	Hi (process variable value is > than Hi.S)													
3	ERR [third wire broken for PT100 or input values below minimum limits (ex. for CT with wrong connection)]													
4	SBR (broken probe or input values above maximum limits)													
				+8 CT input error +16 VT input error +32 Error in detection of expansion card										
477	- - -	R	Error code (bit)	bit.3 Err incorrect probe connection bit.4 Sbr probe interrupted										
bit. 9	- - -	R	Broken sensor SBR											

1.12 SP Configuration (SetPoint)

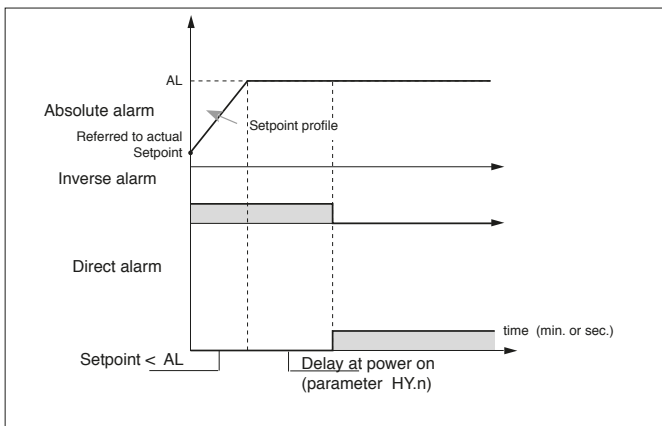

Set gradient application

(ramp+hold+end alarm)

SET GRADIENT:

if set to 0, the setpoint is assumed equal to PV at power-up and when switching between auto/man; with gradient set, it reaches the local set or the one selected.

Every variation of the set is subject to a gradient.

The set gradient is inhibited at power-up when self-tuning is enabled.

If the set gradient is set to 0, it is active even with variations of local setpoints.

The control setpoint reaches the set value at a speed defined by the gradient.

The value of remote setpoint SP.rS is not saved in EEPROM.

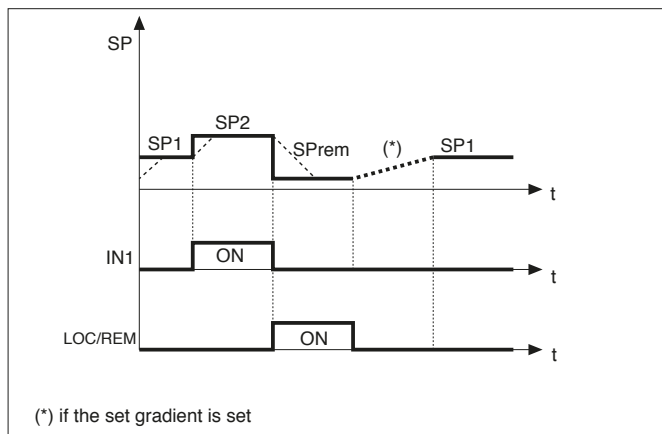

MULTISET FUNCTION

The multiset function is enabled in hd.1.

The gradient function is always enabled.

Selection of set point 1 or set point 2 can be made by digital input.

The selection of set point 1 / 2 can be displayed by LED.

Settings

138
16 - 472

- SP

R/W

Local Setpoint

400

Multiset

191

hd.1

R/W

Enabling multiset instrument management via serial

hd.1	Enabling Multiset	Enabling instrument via serial	If "GTS-L or R" module is present	If "RR" module is present	If "CC" module is present	If "V" module is present
0			X			
1	X		X			
2		X	X			
3	X	X	X			
4				X		
5	X			X		
6		X		X		
7	X	X		X		
8					X	
9	X				X	
10		X			X	
11	X	X			X	
16						X
17						X
18						X
19						X

0

If module "CC" or "RR" present see rL.1 parameter for Out1 and Out7 impostation.
 If module "V" present Out1 = open, Out7 = closed.
 +32 if Out2 = "C" (continuous).
 +64 output 1 function attributed to output 7, Out1 = OFF

230
482

SP.1

R/W

Setpoint 1

100

231
483

SP.2

R/W

Setpoint 2

200

140

d iG.

R/W

Function of digital input

0	none (key disabled)
1	MAN / AUTO controller
2	LOC / REM
3	HOLD
4	Reset alarms memory
5	SP1/SP2 selection
6	Software On/Off switching function
7	None
8	START / STOP Selftuning
9	START / STOP Autotuning

0

+ 16 for inverse logic input
 + 32 to force logic state 0 (OFF)
 + 48 to force logic state 1 (ON)

bit.
75

R/W (*)

SP1-SP2 selection (0 = SP1, 1 = SP2)

(*) in write only if diG. μ 5

25
20 - 28 - 142

LoL

R/W

Lower limit for local setpoint and absolute alarms

Lo.S ... Hi.S

0

26
21 - 29 - 143

HiL

R/W

Upper limit for local setpoint and absolute alarms

Lo.S ... Hi.S

1000

Gradient

234
22

GSP

R/W

Set gradient (see applicable note)

0.0 ... 999.9 digit / min. (digit / sec vedi SP.r)

0,0

265

Hot

Select hot channel functions

Hot	Enable hot channels	Enable FAP parameter	Enable preheating Softstart
0		FAP	
1	X	average power	
2		FAP	
3	X	FAP	
4		FAP	X
5	X	average power	X
6		FAP	X
7	X	FAP	X

0

+ 8 enable GS.2

259

G.S2

R/W

SP2 Set gradient (see applicable note)

0.0 ... 999.9 digit / min. (digit / sec vedi SP.r)

0,0

18
136 - 249

SP.r

R/W

Def. remote Set (SET gradient for manual power correction)

Val.	Type of remote setpoint	Absolute/Relative
0	Digital (from serial line)	Absolute
1	Digital (from serial line)	Relative to local setpoint
2	Auxiliary input	Absolute
3	Auxiliary input	Relative to local setpoint

0

+4 set gradient in digit/sec.
 +8 manual power correction based on grid voltage
 +16 to disable the memorization of the local setpoint
 +32 to disable the memorization of the manual power

Remote setpoint

181	tP.2	R/W	Auxiliary analogue input function	auxiliary input function			SETTING LIMITS		0	
				0	none	LS.2	H.tA1	-		-
				1	remote setpoint	Assolute Lo.S	Assolute Hi.s	relative -999		relative +999
				2	analogue remote manual	-100.0%	+100.0%			
				3	analogue power reset	-100.0%	+100.0%			
				5	valve position	0.0	+100.0%			

250	SP.r5	R/W	Remote setpoint (not memorized in EEPROM)
-----	-------	-----	---

136 249	18	SP.r	R/W	Def. remote Set (SET gradient for manual power correction)	Val.	Type of remote setpoint	Absolute/Relative	0
					0	Digital (from serial line)	Absolute	
					1	Digital (from serial line)	Relative to local setpoint	
					2	Auxiliary input	Absolute	
3	Auxiliary input	Relative to local setpoint						

+4 set gradient in digit/sec.
 +8 manual power correction based on grid voltage
 +16 to disable the memorized of the local setpoint
 +32 to disable the memorized of the manual power

404	LS.2	R/W	Minimum limit auxiliary input	-1999 ... 9999	0
-----	------	-----	-------------------------------	----------------	---

405	H.tA1	R/W	Max. limit input scale current transformer (CT fase 1), auxiliary input	-1999 ... 9999	1000
-----	-------	-----	---	----------------	------

220	o.tA1	R/W	Offset correction current transformer input (CT fase 1), auxiliary input	-99.9 ... 99.9 scale points	0,0
-----	-------	-----	--	-----------------------------	-----

219	FL.tA	R/W	CT input digital filter (fase 1, 2, 3), auxiliary input (if = 0 excludes average filter on sampled value)	0.0 ... 20.0 sec	0,1
-----	-------	-----	---	------------------	-----

bit. 10		R/W	Local/Remote SP
------------	--	-----	-----------------

Status

137 481	1	SPA	R	Active Setpoint
------------	---	-----	---	-----------------

1.13 PID heat/cool configuration

Geflex can manage a heating output and a cooling output in a completely independent manner. All of the parameters involved in heating and cooling are shown below. Parameters for the proportional band, integral time and derivative time are typically calculated with Autotuning/Selftuning.

CONTROL ACTIONS

Proportional Action:

action in which contribution to output is proportional to deviation at input (deviation = difference between controlled variable and setpoint).

Derivative Action:

action in which contribution to output is proportional to rate of variation input deviation.

Integral Action:

action in which contribution to output is proportional to integral of time of input deviation.

Influence of Proportional, Derivative and Integral actions on response of process under control

* An increase in P.B. reduces oscillations but increases deviation.

* A reduction in P.B. reduces the deviation but provokes oscillations of the controlled variable (the system tends to be unstable if P.B. value is too low).

* An increase in Derivative Action corresponds to an increase in Derivative Time, reduces deviation and prevents oscillation up to a critical value of Derivative Time, beyond which deviation increases and prolonged oscillations occur.

* An increase in Integral Action corresponds to a reduction in Integral Time, and tends to eliminate deviation between the controlled variable and the setpoint when the system is running at rated speed.

If the Integral Time value is too long (Weak integral action), deviation between the controlled variable and the setpoint may persist.

Contact GEFTRAN for more information on control actions.

MANUAL TUNING

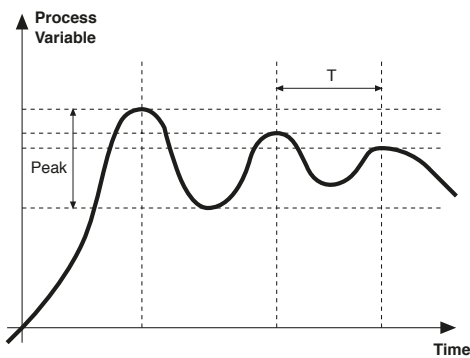

- A) Enter the setpoint at its working value.
- B) Set the proportional band at 0.1% (with on-off type setting).
- C) Switch to automatic and observe the behavior of the variable. It will be similar to that in the figure:
- D) The PID parameters are calculated as follows: Proportional band

$$P.B. = \frac{\text{Peak}}{V \text{ max} - V \text{ min}} \times 100$$

(V max - V min) is the scale range.

Integral time $I_t = 1,5 \times T$

Derivative time $d_t = I_t/4$

E) Switch the unit to manual, set the calculated parameters. Return to PID action by setting the appropriate relay output cycle time, and switch back to Automatic.

F) If possible, to optimize parameters, change the setpoint and check temporary response. If an oscillation persists, increase the proportional band. If the response is too slow, reduce it.

Controls

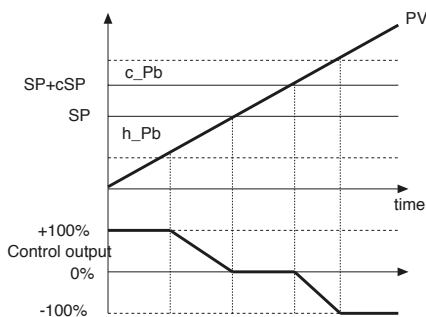

Control output with proportional action only if proportional heating band is separated from proportional cooling band.

PV = process variable
 SP+cSP = cooling setpoint
 c_Pb = proportional cooling band

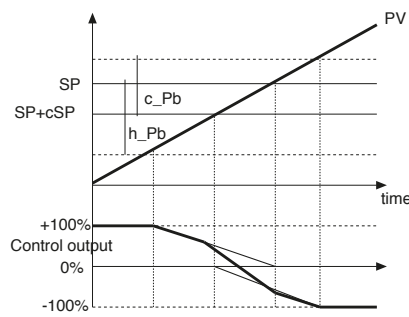

Control output with proportional action only if proportional heating band overlaps proportional cooling band.

SP = heating setpoint
 h_Pb = proportional heating band

Heating/Cooling control with relative gain

In this control mode (enabled with Ctr = 14 parameter) the type of cooling has to be specified.

Cooling PID parameters are therefore calculated based on heating parameters according to the specified ratio.

(e: C.ME = 1 (oil), H_Pb = 10, H_dt = 1, H_lt = 4 implies: C_Pb = 12,5, C_dt = 1, C_lt = 4)

We advise you to apply the following values when setting output cycle times:

Air T Cool Cycle = 10 sec.

Oil T Cool Cycle = 4 sec.

Water T Cool Cycle = 2 sec.

NB.: Cooling parameters **cannot be modified** in this mode.

Settings

180	Ctr	R/W	Control type	6
-----	-----	-----	--------------	---

Val	Control type
0	P heat
1	P cool
2	P heat / cool
3	PI heat
4	PI cool
5	PIheat / cool
6	PID heat
7	PID cool
8	PID heat / cool
9	ON-OFF heat
10	ON-OFF cool
11	ON-OFF heat / cool
12	PID heat + ON-OFF cool
13	ON-OFF heat + PID cool
14	PID heat + cool with relative gain (see C.MEd parameter)

Selection of derivative action sampling time:
 +0 sample 1 sec. +16 sample 4 sec.
 +32 sample 8 sec. +64 sample 240 msec.

Note: LBA alarm is not enabled with ON/OFF type control.
 For correct use of the device, we advise you to set the main input to a full-scale value at least 3 digits higher than the maximum set point settable by the operator.
 This will allow the temperature to be measured and the output to be controlled even under extreme conditions.
 Note that disregard of this advice may provoke holding of the heat output with the set point at maximum.

5 148 - 149	h.Pb	R/W	Proportional band for heating or hysteresis on ON-OFF action	0 ... 999.9% f.s.	1,0
7 150	h.it	R/W	Integral time for heating	0.00 ... 99.99 min	4,00
8 151	h.dt	R/W	Derivative time for heating	0.00 ... 99.99 min	1,00
6	c.Pb	R/W	Proportional band for cooling or hysteresis for ON/OFF control	0 ... 999.9% f.s.	1,0
76	c.it	R/W	Integral time for cooling	0.00 ... 99.99 min	4,00
77	c.dt	R/W	Derivative time for cooling	0.00 ... 99.99 min	1,00

Note:
 Parameters c_Pb, c_it, c_dt are read only in case of enabling control type heat/cool with relative gain (Ctr = 14)

39 484	c.SP	R/W	Setpoint for cooling relative to heating setpoint	±25.0% f.s.	0,0
513	C.ME	R/W	Cooling medium	0 ... 2	0

C.MEd		Relative Gain (rG) (see note)
0	Air	1
1	Oil	0.8
2	Water	0.4

152 9	Ct.1	R/W	Cycle time for Out1 (Heat)	1...200 sec. (0.1 ... 20.0 sec.)	Set to 0 for GTT function	20
Set to 100msec if hd1 = 8...11, "CC" module						

159	Ct.2	R/W	Cycle time for Out2 (Cool)	1...200 sec. (0.1 ... 20.0 sec.)	Also used for output 7 in case of +4 in hd.1	20
Set to 100msec if +32 in hd1, Out2 = "C" (continuous)						

78	rSt	R/W	Manual reset	-999 ... 999 scale points	0
516	P.rS	R/W	Reset power	-100.0 ... 100.0%	0,0
79	A.rS	R/W	Antireset	0 ... 9999 scale points	0
80	FFd	R/W	Feedforward	-100.0 ... 100.0%	0,0

42 146	h.P.H	R/W	Maximum power limit for heating	0.0 ... 100.0%	100,0
254	h.P.L	R/W	Minimum power limit for heating (not available for double heat/cool action)	0.0 ... 100.0%	0,0
43	c.P.H	R/W	Maximum power limit for cooling	0.0 ... 100.0%	100,0
255	c.P.L	R/W	Minimum power limit for cooling (not available for heating/cooling double action)	0.0 ... 100.0%	0,0

Status

477 467	- - -	R	Instrument status
------------	-------	---	-------------------

bit	
0	AL1 or AL2 or AL3 or AL4 or ALHB.TA1, ALHB.TA2, ALHB.TA3
1	input Lo
2	input Hi
3	input Err
4	input Sbr
5	HEAT
6	COOL
7	LBA
8	AL1
9	AL2
10	AL3
11	AL4
12	ALHB
13	ON/OFF
14	AUTO/MAN
15	LOC/REM

2 132 - 471	0.0.P	R	Control output value (+Heat / -Cool)
----------------	--------------	---	--------------------------------------

W (only in manual mode at address 252)

1.14 Autotuning, Selftuning, Softstart

1.14.1 Autotuning

PID parameters cannot be set if the auto-tuning function is enabled.

Auto-tuning continuously measures system oscillations to find the optimum PID values to reduce such oscillations. It does not engage if the oscillations drop below 1.0% of the proportional band.

It is interrupted if the setpoint is changed, and is automatically resumed when the setpoint stabilizes. The calculated parameters are not stored. If the unit is switched off, the controller reverts to the values set before self-tuning was enabled.

Auto-tuning with switching to Manual ends the procedure.

Enabling the auto-tuning function blocks the settings of the PID parameters.

It can be one of two types: permanent (continuous) or single-action (one-shot).

* Continuous auto-tuning is activated via the Stu parameter (values 1, 3, 5). It continuously reads system oscillations, immediately seeking the PID parameter values that reduce the current oscillation. It does not engage if the oscillations drop below 1.0% of the proportional band.

It is interrupted if the set-point is changed, and automatically resumes with a constant set-point. The calculated parameters are not saved if the instrument is switched off, if the instrument is switched to manual, or if the configuration code is disabled. The controller resumes with the parameters programmed before auto-tuning was enabled.

The calculated parameters are saved when the function is enabled from the digital input or from the A/M (start/stop) key if the procedure is interrupted.

* One-shot auto-tuning can be enabled manually or automatically. It is activated via the Stu parameter (as can be seen on the table, the values to be set depend on whether Self-tuning or Soft-start is enabled.).

It is useful for calculation of PID parameters when the system is around the set-point. It produces a variation on the control output at a maximum of $\pm 100\%$ of the current control power limited by h.PH - h.PL (hot), c.PH - c.PL (cold), and assesses the effects in timed overshoot. The calculated parameters are saved.

Manual activation (Stu code = 8, 10, 12) via direct setting of the parameter or via digital input or via key.

Automatic activation (Stu code = 24, 26, 28 with error band of 0.5%) when the PV-SP error exceeds the preset band (programmable to 0.5%, 1%, 2%, 4% of full scale).

NB: at power-up, or after a change of set-point, automatic activation is inhibited for a time equal to five times the integral time, with a minimum of 5 minutes.

The same time has to run after one-shot

Settings

31	Stu	R/W	Enabling selftuning, autotuning, softstart	<table border="1"> <thead> <tr> <th>S.tu</th> <th>Continuous autotuning / one shot</th> <th>Selftuning</th> <th>Softstart</th> </tr> </thead> <tbody> <tr><td>0</td><td>NO</td><td>NO</td><td>NO</td></tr> <tr><td>1</td><td>YES</td><td>NO</td><td>NO</td></tr> <tr><td>2</td><td>NO</td><td>YES</td><td>NO</td></tr> <tr><td>3</td><td>YES</td><td>YES</td><td>NO</td></tr> <tr><td>4</td><td>NO</td><td>NO</td><td>YES</td></tr> <tr><td>5</td><td>YES</td><td>NO</td><td>YES</td></tr> <tr><td>6</td><td>-</td><td>-</td><td>-</td></tr> <tr><td>7</td><td>-</td><td>-</td><td>-</td></tr> <tr><td>8 *</td><td>WAIT</td><td>NO</td><td>NO</td></tr> <tr><td>9</td><td>GO</td><td>NO</td><td>NO</td></tr> <tr><td>10 *</td><td>WAIT</td><td>YES</td><td>NO</td></tr> <tr><td>11</td><td>GO</td><td>YES</td><td>NO</td></tr> <tr><td>12 *</td><td>WAIT</td><td>NO</td><td>YES</td></tr> <tr><td>13</td><td>GO</td><td>NO</td><td>YES</td></tr> </tbody> </table>	S.tu	Continuous autotuning / one shot	Selftuning	Softstart	0	NO	NO	NO	1	YES	NO	NO	2	NO	YES	NO	3	YES	YES	NO	4	NO	NO	YES	5	YES	NO	YES	6	-	-	-	7	-	-	-	8 *	WAIT	NO	NO	9	GO	NO	NO	10 *	WAIT	YES	NO	11	GO	YES	NO	12 *	WAIT	NO	YES	13	GO	NO	YES	0
S.tu	Continuous autotuning / one shot	Selftuning	Softstart																																																														
0	NO	NO	NO																																																														
1	YES	NO	NO																																																														
2	NO	YES	NO																																																														
3	YES	YES	NO																																																														
4	NO	NO	YES																																																														
5	YES	NO	YES																																																														
6	-	-	-																																																														
7	-	-	-																																																														
8 *	WAIT	NO	NO																																																														
9	GO	NO	NO																																																														
10 *	WAIT	YES	NO																																																														
11	GO	YES	NO																																																														
12 *	WAIT	NO	YES																																																														
13	GO	NO	YES																																																														

(See note)

(*) +16 with automatic switch to GO if PV-SP > 0,5% f.s.
 +32 with automatic switch to GO if PV-SP > 1% f.s.
 +64 with automatic switch to GO if PV-SP > 2% f.s.
 +128 with automatic switch to GO if PV-SP > 4% f.s.

140	d iG	R/W	Function of digital input	<table border="1"> <tbody> <tr><td>0</td><td>none (key disabled)</td></tr> <tr><td>1</td><td>MAN / AUTO controller</td></tr> <tr><td>2</td><td>LOC / REM</td></tr> <tr><td>3</td><td>HOLD</td></tr> <tr><td>4</td><td>Reset alarms memory</td></tr> <tr><td>5</td><td>SP1/SP2 selection</td></tr> <tr><td>6</td><td>Software On/Off switching function</td></tr> <tr><td>7</td><td>None</td></tr> <tr><td>8</td><td>START / STOP Selftuning</td></tr> <tr><td>9</td><td>START / STOP Autotuning</td></tr> </tbody> </table>	0	none (key disabled)	1	MAN / AUTO controller	2	LOC / REM	3	HOLD	4	Reset alarms memory	5	SP1/SP2 selection	6	Software On/Off switching function	7	None	8	START / STOP Selftuning	9	START / STOP Autotuning	0
0	none (key disabled)																								
1	MAN / AUTO controller																								
2	LOC / REM																								
3	HOLD																								
4	Reset alarms memory																								
5	SP1/SP2 selection																								
6	Software On/Off switching function																								
7	None																								
8	START / STOP Selftuning																								
9	START / STOP Autotuning																								

+ 16 for inverse logic input
 + 32 to force logic state 0 (OFF)
 + 48 to force logic state 1 (ON)

305	- - -	R/W	STATUS_W	<table border="1"> <thead> <tr><th>bit</th><th></th></tr> </thead> <tbody> <tr><td>1</td><td>SP1/SP2</td></tr> <tr><td>2</td><td>Start/stop selftuning</td></tr> <tr><td>3</td><td>ON/OFF</td></tr> <tr><td>4</td><td>AUTO/MAN</td></tr> <tr><td>5</td><td>Start/stop autotuning</td></tr> <tr><td>6</td><td>LOC/REM</td></tr> </tbody> </table>	bit		1	SP1/SP2	2	Start/stop selftuning	3	ON/OFF	4	AUTO/MAN	5	Start/stop autotuning	6	LOC/REM
bit																		
1	SP1/SP2																	
2	Start/stop selftuning																	
3	ON/OFF																	
4	AUTO/MAN																	
5	Start/stop autotuning																	
6	LOC/REM																	

bit.	- - -	R/W	Autotuning (Stop = 0, Start = 1)
29	- - -		

Status

bit.	- - -	R	Active Autotuning
28	- - -		

bit.	- - -	R	Digital input status
68	- - -		

1.14.2 Selftuning

The function works for single output systems (heating or cooling).

The self-tuning action calculates optimum control parameter values during process startup, the variable (for example, temperature) must be that assumed at zero power (room temperature).

The controller supplies maximum power until an intermediate value between starting value and setpoint is reached, after which it zeros power. PID parameters are calculated by measuring overshoot and the time needed to reach peak.

When calculations are finished, the system disables automatically and the control proceeds until the setpoint is reached.

How to activate self-tuning:

A. Activation at switch-on

1. Adjust setpoint to required value
3. Enable self-tuning by setting **Stu** parameter to 2
4. Switch unit off
5. Make sure that temperature is approximately room temperature
6. Switch the unit on

B. Activate via serial command

1. Make sure that temperature is approximately room temperature
2. Adjust setpoint to required value
3. Give the Start Selftuning command

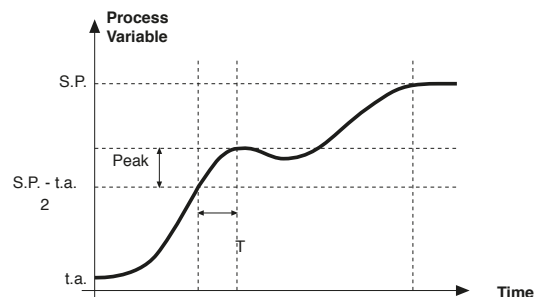

The procedure runs automatically until finished, when the new PID parameters are stored: proportional band, integral and derivative times calculated for the active action (heating or cooling). In case of double action (heating or cooling), parameters for the opposite action are calculated by maintaining the initial ratio between parameters (ex.: $CPb = HPb * K$; where $K = CPb / HPb$ when self-tuning starts). When finished, the **Stu** code is automatically cancelled.

Notes:

-The procedure does not start if the temperature is higher than the setpoint (heating control mode) or if the temperature is lower than the setpoint (cooling control mode). In this case, the **Stu** code is not cancelled.

- It is good practice to enable one of the configurable LEDs to signal self-tuning status.

By setting Ld.St = 4 on the Hrd menu, the corresponding LED will be on (or flashing) when self-tuning is active.

N.B.: Action not considered in ON/OFF type of control

Settings

31 **Stu** R/W Enabling selftuning, autotuning, softstart (See note) 0

S.tu	Continuous autotuning / one shot	Selftuning	Softstart
0	NO	NO	NO
1	YES	NO	NO
2	NO	YES	NO
3	YES	YES	NO
4	NO	NO	YES
5	YES	NO	YES
6	-	-	-
7	-	-	-
8*	WAIT	NO	NO
9	GO	NO	NO
10*	WAIT	YES	NO
11	GO	YES	NO
12*	WAIT	NO	YES
13	GO	NO	YES

(*) +16 with automatic switch to GO if PV-SP > 0,5% f.s.
 +32 with automatic switch to GO if PV-SP > 1% f.s.
 +64 with automatic switch to GO if PV-SP > 2% f.s.
 +128 with automatic switch to GO if PV-SP > 4% f.s.

140 **d iG** R/W Function of digital input 0

0	none (key disabled)
1	MAN / AUTO controller
2	LOC / REM
3	HOLD
4	Reset alarms memory
5	SP1/SP2 selection
6	Software On/Off switching function
7	None
8	START / STOP Selftuning
9	START / STOP Autotuning

+ 16 for inverse logic input
 + 32 to force logic state 0 (OFF)
 + 48 to force logic state 1 (ON)

305 - - - R/W STATUS_W

bit	
1	SP1/SP2
2	Start/stop selftuning
3	ON/OFF
4	AUTO/MAN
5	Start/stop autotuning
6	LOC/REM

bit. 3 - - - R/W Selftuning (Stop = 0, Start = 1)

Status

bit. 0 - - - R Active Selftuning

bit. 68 - - - R Digital input status

1.14.3 Softstart

If enabled, the function chokes power based on a percentage of the time elapsed since the instrument was turned on compared to the set time 0.0 ... 500.0 min (parameter " SoFt " phase CFG). Soft-start is an alternative to self-tuning, and is activated each time the instrument is turned on. The Soft-Start function is deactivated when the instrument is switched to manual.

Settings

31 **Stu** R/W Enabling selftuning, autotuning, softstart (See note) 0

S.tu	Continuous autotuning / one shot	Selftuning	Softstart
0	NO	NO	NO
1	YES	NO	NO
2	NO	YES	NO
3	YES	YES	NO
4	NO	NO	YES
5	YES	NO	YES
6	-	-	-
7	-	-	-
8*	WAIT	NO	NO
9	GO	NO	NO
10*	WAIT	YES	NO
11	GO	YES	NO
12*	WAIT	NO	YES
13	GO	NO	YES

(*) +16 with automatic switch to GO if PV-SP > 0,5% f.s.
 +32 with automatic switch to GO if PV-SP > 1% f.s.
 +64 with automatic switch to GO if PV-SP > 2% f.s.
 +128 with automatic switch to GO if PV-SP > 4% f.s.

147 **SoF** R/W Softstart time 0.0 ... 500.0 min 0,0

Status

bit. 63 - - - R Softstart in progress

1.15 Software Off

Software shutdown has the following consequences:

- 1) Reset Auto-tuning, Self-tuning and Soft-start functions
- 2) Digital input (if present) enabled only if linked to SW shutdown function
- 3) In case of restart after SW shutdown, the ramp linked to the set starts from the PV.
- 4) Outputs OFF: except for OUT4 (Master) and OUT6 (Slave) of the Geflex instrument, which are forced ON
- 5) Reset HB alarm
- 6) Reset LBA alarm
- 7) In case of Geflex, Heat and Cool bit of status word STATUS_ST_RAM and POWER are reset.
- 8) The current power level is saved when the instrument is switched off. When it is switched on again, integral power is calculated as the difference between saved power and proportional power. This calculation is defined as "desaturation at switch-on".
- 9) In case of Geflex, the state of alarms (AL1...AL4, ALHB TA1...ALHBT3) is reset.

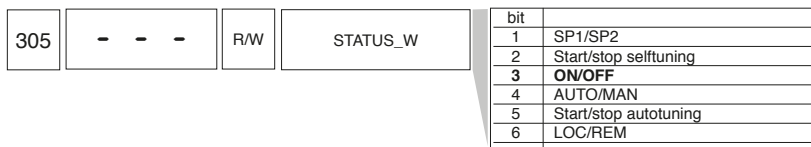
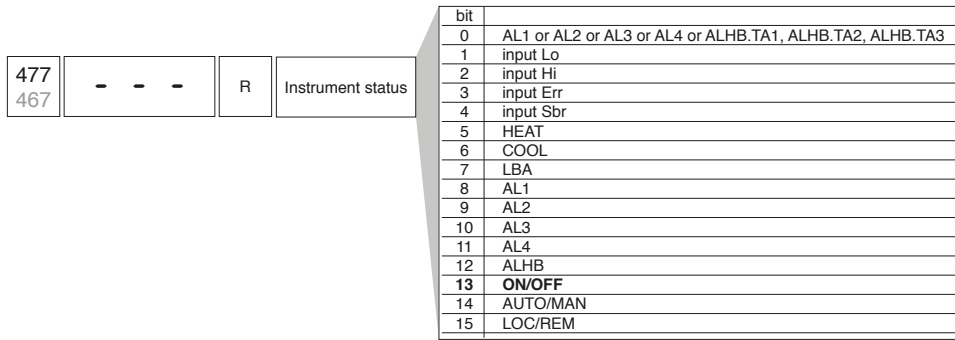
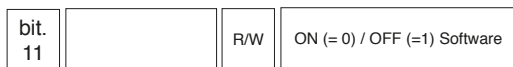
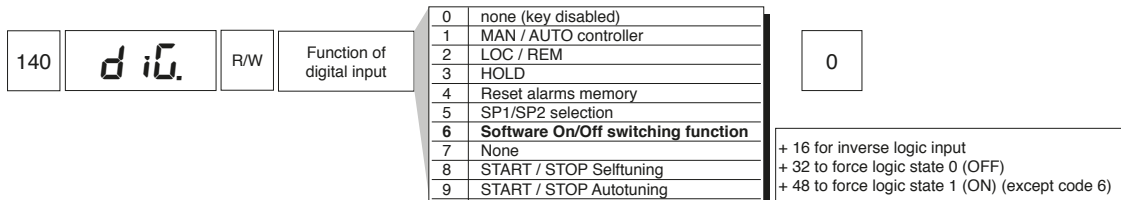

1.16 Manual Configuration

By setting parameter diG. (digital input function), you can bring the Geflex to manual state and set the power output to the desired value.

Settings

252 478	- - -	W	Power in manual	-100.0 ... 100.0%	0,0																				
140	d iG.	R/W	Function of digital input	<table border="1"> <tr><td>0</td><td>none (key disabled)</td></tr> <tr><td>1</td><td>MAN / AUTO controller</td></tr> <tr><td>2</td><td>LOC / REM</td></tr> <tr><td>3</td><td>HOLD</td></tr> <tr><td>4</td><td>Reset alarms memory</td></tr> <tr><td>5</td><td>SP1/SP2 selection</td></tr> <tr><td>6</td><td>Software On/Off switching function</td></tr> <tr><td>7</td><td>None</td></tr> <tr><td>8</td><td>START / STOP Selftuning</td></tr> <tr><td>9</td><td>START / STOP Autotuning</td></tr> </table>	0	none (key disabled)	1	MAN / AUTO controller	2	LOC / REM	3	HOLD	4	Reset alarms memory	5	SP1/SP2 selection	6	Software On/Off switching function	7	None	8	START / STOP Selftuning	9	START / STOP Autotuning	0
0	none (key disabled)																								
1	MAN / AUTO controller																								
2	LOC / REM																								
3	HOLD																								
4	Reset alarms memory																								
5	SP1/SP2 selection																								
6	Software On/Off switching function																								
7	None																								
8	START / STOP Selftuning																								
9	START / STOP Autotuning																								
+ 16 for inverse logic input + 32 to force logic state 0 (OFF) + 48 to force logic state 1 (ON)																									
bit. 1	- - -	R/W	AUTO/MAN from serial																						

Status

bit. 68	- - -	R	Digital input status
------------	-------	---	----------------------

1.17 Manual power correction based on network voltage

Setting for models with diagnostics option CV.

You can use this function to correct the power delivered in manual based on the reference grid voltage (riF). The % value of the correction (Cor) is freely settable and acts in an inversely proportional manner. The function can be activated/deactivated with parameter SP.r.

Ex. Cor. = 10%; riF = 380; SP.r = value + 8; instrument in manual; network voltage 380VAC, manual power 50%.

If there is a variation of +10% in grid voltage, $380V + 10\% (380V) = 418V$, it corresponds to a reduction of manual set power equal to the same % of variation $50\% - 10\% (50\%) = 45\%$

To use this function, the Geflex has to have a TA (current transformer) and TV (voltmeter transformer).

N.B.: the % variation in manual power is limited to the value set for the "Cor" parameter.

The maximum manual power correction is limited to $\pm 65\%$.

505	r iF	R/W	Voltage	0.0 ... 999.9	0,0															
506	Cor	R/W	Manual power correction based on network voltage	0.0 ... 100.0%	0,0															
18 136 - 249	SP.r	R/W	Def. remote Set (SET gradient for manual power correction)	<table border="1"> <thead> <tr> <th>Val.</th> <th>Type of remote setpoint</th> <th>Absolute/Relative</th> </tr> </thead> <tbody> <tr> <td>0</td> <td>Digital (from serial line)</td> <td>Absolute</td> </tr> <tr> <td>1</td> <td>Digital (from serial line)</td> <td>Relative to local setpoint</td> </tr> <tr> <td>2</td> <td>Auxiliary input</td> <td>Absolute</td> </tr> <tr> <td>3</td> <td>Auxiliary input</td> <td>Relative to local setpoint</td> </tr> </tbody> </table>	Val.	Type of remote setpoint	Absolute/Relative	0	Digital (from serial line)	Absolute	1	Digital (from serial line)	Relative to local setpoint	2	Auxiliary input	Absolute	3	Auxiliary input	Relative to local setpoint	
Val.	Type of remote setpoint	Absolute/Relative																		
0	Digital (from serial line)	Absolute																		
1	Digital (from serial line)	Relative to local setpoint																		
2	Auxiliary input	Absolute																		
3	Auxiliary input	Relative to local setpoint																		
+4 set gradient in digit/sec. +8 manual power correction based on grid voltage +16 to disable the memorized of the local setpoint +32 to disable the memorized of the manual power																				

1.18 Configuration of hot channels

You can use the following parameters to perform a specific configuration for the channels (hot.runners). The main functions are:

Fault Action Power

In case of broken probe, you can decide how much power to deliver.

FAP is the reference power for parameter FAP.

Average power is the average power calculated in the last 300 sec

Power alarm

This alarm signals any power changes (OuP) after the process variable (PV) has stabilized on the setpoint (SP).

The time beyond which the process variable is considered stable is 300 sec. It is always active with the hot channels option activated.

Updating of the reference power occurs only at power-up or after a change of setpoint.

If the process variable leaves the stabilization band after the first stabilization, this does not affect the alarm.

In case of SBR:

- if the PV has not yet stabilized, either the average power for the last 5 minutes or FAP power (according to the HOT parameter) is supplied.
- if the PV has stabilized, the average power for the last 5 minutes is supplied.

Function:

If necessary, assign an output (rL.2...6) for the power alarm.

Set the band (b.ST) within which the process variable will be considered stable after 300 sec. have elapsed.

Set the band (b.PF) outside which the alarm will trip after 300 sec. have elapsed.

The reference power is the level read after 300 sec. have elapsed.

The alarm is reset and the reference power is updated only at power-up or after changing the setpoint.

The alarm is not activated if control (Ctr) is ON/OFF, during Self Tuning and in Manual.

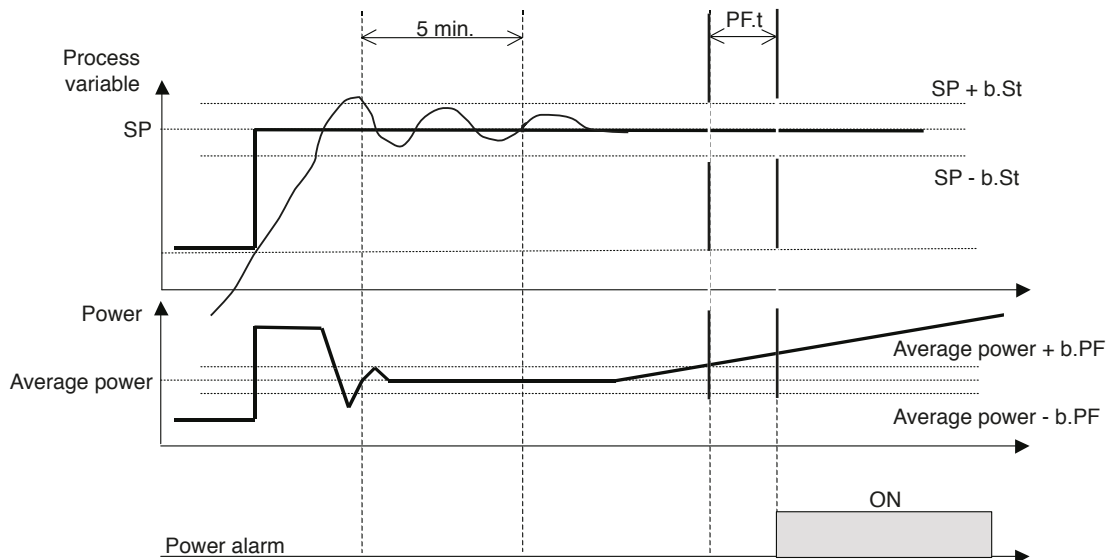

Preheating Softstart

This function lets you deliver settable power (So.P) for time interval (SoF), after which normal control via PID is resumed.

The software is activated only at power-up. With manual-automatic switching during the Softstart phase, the time restarts from 0 only if the process variable is below the SP.S. limit.

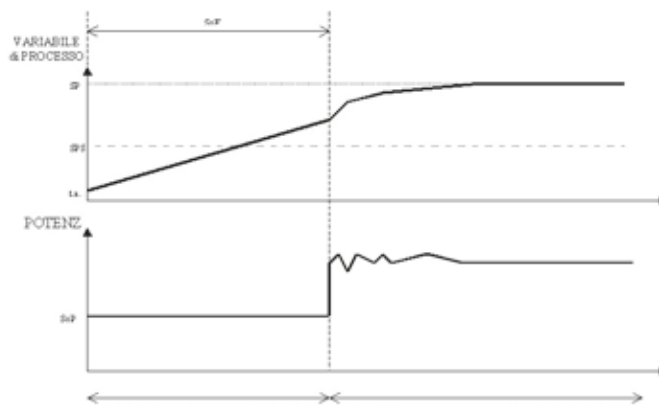

Heating output with fast cycle time

You can set a fast cycle time (0.1 ... 20 sec.) for outputs rL.1(Out1) and rL.2(Out2)

265	Hot	Selezione funzioni canali caldi	<table border="1"> <thead> <tr> <th>Val</th> <th>Enable hot channels</th> <th>Fault action Power</th> <th>Abilitazione preheating Softstart</th> </tr> </thead> <tbody> <tr><td>0</td><td>-</td><td>FA.P</td><td></td></tr> <tr><td>1</td><td>x</td><td>average power</td><td></td></tr> <tr><td>2</td><td>-</td><td>FA.P</td><td></td></tr> <tr><td>3</td><td>x</td><td>FA.P</td><td></td></tr> <tr><td>4</td><td>-</td><td>FA.P</td><td>x</td></tr> <tr><td>5</td><td>x</td><td>average power</td><td>x</td></tr> <tr><td>6</td><td>-</td><td>FA.P</td><td>x</td></tr> <tr><td>7</td><td>x</td><td>FA.P</td><td>x</td></tr> </tbody> </table>	Val	Enable hot channels	Fault action Power	Abilitazione preheating Softstart	0	-	FA.P		1	x	average power		2	-	FA.P		3	x	FA.P		4	-	FA.P	x	5	x	average power	x	6	-	FA.P	x	7	x	FA.P	x	0
Val	Enable hot channels	Fault action Power	Abilitazione preheating Softstart																																					
0	-	FA.P																																						
1	x	average power																																						
2	-	FA.P																																						
3	x	FA.P																																						
4	-	FA.P	x																																					
5	x	average power	x																																					
6	-	FA.P	x																																					
7	x	FA.P	x																																					

+ 8 enable GS.2

160	rL.1	R/W	Out 1 Attribuzione segnali di riferimento	<table border="1"> <thead> <tr> <th>Val</th> <th>Function</th> </tr> </thead> <tbody> <tr><td>0</td><td>HEAT (control output for heating) / in case of continuous OUT 2 output 0...20mA / 0...10V</td></tr> <tr><td>1</td><td>COOL (control output for cooling) / in case of continuous OUT 2 output 0...20mA / 0...10V</td></tr> <tr><td>2</td><td>AL1 - alarm 1</td></tr> <tr><td>3</td><td>AL2 - alarm 2</td></tr> <tr><td>4</td><td>AL3 - alarm 3</td></tr> <tr><td>5</td><td>AL.HB - alarm HB (TA1)</td></tr> <tr><td>6</td><td>LBA - alarm LBA</td></tr> <tr><td>7</td><td>IN - repetition of logic input</td></tr> <tr><td>8</td><td>AL4 - alarm 4</td></tr> <tr><td>9</td><td>AL1 or AL2</td></tr> <tr><td>10</td><td>AL1 or AL2 or AL3</td></tr> <tr><td>11</td><td>AL1 or AL2 or AL3 or AL4</td></tr> <tr><td>12</td><td>AL1 and AL2</td></tr> <tr><td>13</td><td>AL1 and AL2 and AL3</td></tr> <tr><td>14</td><td>AL1 and AL2 and AL3 and AL4</td></tr> <tr><td>15</td><td>AL1 or ALHB</td></tr> <tr><td>16</td><td>AL1 or AL2 or ALHB (TA1)</td></tr> <tr><td>17</td><td>AL1 and ALHB</td></tr> <tr><td>18</td><td>AL1 and AL2 and ALHB (TA1)</td></tr> <tr><td>19</td><td>AL.HB - alarm HB (TA2)</td></tr> <tr><td>20</td><td>AL.HB - alarm HB (TA3)</td></tr> <tr><td>21</td><td>Setpoint power alarm</td></tr> <tr><td>64</td><td>HEAT (heat control output) with fast cycle time 0.1 ... 20.0sec. / in case of continuous OUT 2 output 4...20mA / 2...10V</td></tr> <tr><td>65</td><td>COOL (cool control output) with fast cycle time 0.1 ... 20.0sec. / in case of continuous OUT 2 output 4...20mA / 2...10V</td></tr> </tbody> </table>	Val	Function	0	HEAT (control output for heating) / in case of continuous OUT 2 output 0...20mA / 0...10V	1	COOL (control output for cooling) / in case of continuous OUT 2 output 0...20mA / 0...10V	2	AL1 - alarm 1	3	AL2 - alarm 2	4	AL3 - alarm 3	5	AL.HB - alarm HB (TA1)	6	LBA - alarm LBA	7	IN - repetition of logic input	8	AL4 - alarm 4	9	AL1 or AL2	10	AL1 or AL2 or AL3	11	AL1 or AL2 or AL3 or AL4	12	AL1 and AL2	13	AL1 and AL2 and AL3	14	AL1 and AL2 and AL3 and AL4	15	AL1 or ALHB	16	AL1 or AL2 or ALHB (TA1)	17	AL1 and ALHB	18	AL1 and AL2 and ALHB (TA1)	19	AL.HB - alarm HB (TA2)	20	AL.HB - alarm HB (TA3)	21	Setpoint power alarm	64	HEAT (heat control output) with fast cycle time 0.1 ... 20.0sec. / in case of continuous OUT 2 output 4...20mA / 2...10V	65	COOL (cool control output) with fast cycle time 0.1 ... 20.0sec. / in case of continuous OUT 2 output 4...20mA / 2...10V	0
Val	Function																																																						
0	HEAT (control output for heating) / in case of continuous OUT 2 output 0...20mA / 0...10V																																																						
1	COOL (control output for cooling) / in case of continuous OUT 2 output 0...20mA / 0...10V																																																						
2	AL1 - alarm 1																																																						
3	AL2 - alarm 2																																																						
4	AL3 - alarm 3																																																						
5	AL.HB - alarm HB (TA1)																																																						
6	LBA - alarm LBA																																																						
7	IN - repetition of logic input																																																						
8	AL4 - alarm 4																																																						
9	AL1 or AL2																																																						
10	AL1 or AL2 or AL3																																																						
11	AL1 or AL2 or AL3 or AL4																																																						
12	AL1 and AL2																																																						
13	AL1 and AL2 and AL3																																																						
14	AL1 and AL2 and AL3 and AL4																																																						
15	AL1 or ALHB																																																						
16	AL1 or AL2 or ALHB (TA1)																																																						
17	AL1 and ALHB																																																						
18	AL1 and AL2 and ALHB (TA1)																																																						
19	AL.HB - alarm HB (TA2)																																																						
20	AL.HB - alarm HB (TA3)																																																						
21	Setpoint power alarm																																																						
64	HEAT (heat control output) with fast cycle time 0.1 ... 20.0sec. / in case of continuous OUT 2 output 4...20mA / 2...10V																																																						
65	COOL (cool control output) with fast cycle time 0.1 ... 20.0sec. / in case of continuous OUT 2 output 4...20mA / 2...10V																																																						
163	rL.2	R/W	Out 2 Attribuzione segnale di riferimento	1																																																			

+ 32 for inverse logic signal output
+ 128 to force output to zero
(not valid for continuous OUT2 and for 64 and 65 function)

Power alarm

261	b.St	R/W	Stability band (hot channels power alarm function)	0 ... 100.0% f.s.	0,0
262	b.PF	R/W	Power alarm band (hot channels power alarm function)	0 ... 100.0%	0,0
260	P.F.t	R/W	Power alarm trip delay time (hot channels)	0 ... 999 sec	0

166	rL.3	R/W	Out 3 Allocation of reference signal	<table border="1"> <thead> <tr> <th>Val</th> <th>Function</th> </tr> </thead> <tbody> <tr><td>0</td><td>copies state of output rL.1 **</td></tr> <tr><td>1</td><td>copies state of output rL.2 **</td></tr> <tr><td>2</td><td>AL1 - alarm 1</td></tr> <tr><td>3</td><td>AL2 - alarm 2</td></tr> <tr><td>4</td><td>AL3 - alarm 3</td></tr> <tr><td>5</td><td>AL.HB - alarm HB (TA1)</td></tr> <tr><td>6</td><td>LBA - alarm LBA</td></tr> <tr><td>7</td><td>IN - repetition of logic input</td></tr> <tr><td>8</td><td>AL4 - alarm 4</td></tr> <tr><td>9</td><td>AL1 or AL2</td></tr> <tr><td>10</td><td>AL1 or AL2 or AL3</td></tr> <tr><td>11</td><td>AL1 or AL2 or AL3 or AL4</td></tr> <tr><td>12</td><td>AL1 and AL2</td></tr> <tr><td>13</td><td>AL1 and AL2 and AL3</td></tr> <tr><td>14</td><td>AL1 and AL2 and AL3 and AL4</td></tr> <tr><td>15</td><td>AL1 or ALHB</td></tr> <tr><td>16</td><td>AL1 or AL2 or ALHB (TA1)</td></tr> <tr><td>17</td><td>AL1 and ALHB</td></tr> <tr><td>18</td><td>AL1 and AL2 and ALHB (TA1)</td></tr> <tr><td>19</td><td>AL.HB - alarm HB (TA2)</td></tr> <tr><td>20</td><td>AL.HB - alarm HB (TA3)</td></tr> <tr><td>21</td><td>Setpoint power alarm</td></tr> </tbody> </table>	Val	Function	0	copies state of output rL.1 **	1	copies state of output rL.2 **	2	AL1 - alarm 1	3	AL2 - alarm 2	4	AL3 - alarm 3	5	AL.HB - alarm HB (TA1)	6	LBA - alarm LBA	7	IN - repetition of logic input	8	AL4 - alarm 4	9	AL1 or AL2	10	AL1 or AL2 or AL3	11	AL1 or AL2 or AL3 or AL4	12	AL1 and AL2	13	AL1 and AL2 and AL3	14	AL1 and AL2 and AL3 and AL4	15	AL1 or ALHB	16	AL1 or AL2 or ALHB (TA1)	17	AL1 and ALHB	18	AL1 and AL2 and ALHB (TA1)	19	AL.HB - alarm HB (TA2)	20	AL.HB - alarm HB (TA3)	21	Setpoint power alarm	2
Val	Function																																																		
0	copies state of output rL.1 **																																																		
1	copies state of output rL.2 **																																																		
2	AL1 - alarm 1																																																		
3	AL2 - alarm 2																																																		
4	AL3 - alarm 3																																																		
5	AL.HB - alarm HB (TA1)																																																		
6	LBA - alarm LBA																																																		
7	IN - repetition of logic input																																																		
8	AL4 - alarm 4																																																		
9	AL1 or AL2																																																		
10	AL1 or AL2 or AL3																																																		
11	AL1 or AL2 or AL3 or AL4																																																		
12	AL1 and AL2																																																		
13	AL1 and AL2 and AL3																																																		
14	AL1 and AL2 and AL3 and AL4																																																		
15	AL1 or ALHB																																																		
16	AL1 or AL2 or ALHB (TA1)																																																		
17	AL1 and ALHB																																																		
18	AL1 and AL2 and ALHB (TA1)																																																		
19	AL.HB - alarm HB (TA2)																																																		
20	AL.HB - alarm HB (TA3)																																																		
21	Setpoint power alarm																																																		
170	rL.4	R/W	Out 4 Allocation of reference signal	3																																															
171	rL.5	R/W	Out 5 Allocation of reference signal	4																																															
172	rL.6	R/W	Out 6 Allocation of reference signal	5																																															

+ 32 for inverse logic signal output
+ 128 to force output to zero

** NB.:
for rL.3 / rL.4 only, copies state of output rL.1 or rL.2 i.e., replicates ON or OFF state of configured output.

On the Geflex Master, if single, output rL.4 always replicates the state of rL.1 or rL.2 whereas if a slave is present, output rL.4 (being in AND) does not replicate the state.

Status

bit. 80	- - -	R	Power alarm state
------------	-------	---	-------------------

Preheating softstart

31	Stu	R/W	Enabling selftuning, autotuning, softstart	<table border="1"> <thead> <tr> <th>S.tu</th> <th>Continuous autotuning / one shot</th> <th>Selftuning</th> <th>Softstart</th> </tr> </thead> <tbody> <tr><td>0</td><td>NO</td><td>NO</td><td>NO</td></tr> <tr><td>1</td><td>YES</td><td>NO</td><td>NO</td></tr> <tr><td>2</td><td>NO</td><td>YES</td><td>NO</td></tr> <tr><td>3</td><td>YES</td><td>YES</td><td>NO</td></tr> <tr><td>4</td><td>NO</td><td>NO</td><td>YES</td></tr> <tr><td>5</td><td>YES</td><td>NO</td><td>YES</td></tr> <tr><td>6</td><td>-</td><td>-</td><td>-</td></tr> <tr><td>7</td><td>-</td><td>-</td><td>-</td></tr> <tr><td>8*</td><td>WAIT</td><td>NO</td><td>NO</td></tr> <tr><td>9</td><td>GO</td><td>YES</td><td>NO</td></tr> <tr><td>10*</td><td>WAIT</td><td>YES</td><td>NO</td></tr> <tr><td>11</td><td>GO</td><td>YES</td><td>NO</td></tr> <tr><td>12*</td><td>WAIT</td><td>NO</td><td>YES</td></tr> <tr><td>13</td><td>GO</td><td>NO</td><td>YES</td></tr> </tbody> </table>	S.tu	Continuous autotuning / one shot	Selftuning	Softstart	0	NO	NO	NO	1	YES	NO	NO	2	NO	YES	NO	3	YES	YES	NO	4	NO	NO	YES	5	YES	NO	YES	6	-	-	-	7	-	-	-	8*	WAIT	NO	NO	9	GO	YES	NO	10*	WAIT	YES	NO	11	GO	YES	NO	12*	WAIT	NO	YES	13	GO	NO	YES	0
S.tu	Continuous autotuning / one shot	Selftuning	Softstart																																																														
0	NO	NO	NO																																																														
1	YES	NO	NO																																																														
2	NO	YES	NO																																																														
3	YES	YES	NO																																																														
4	NO	NO	YES																																																														
5	YES	NO	YES																																																														
6	-	-	-																																																														
7	-	-	-																																																														
8*	WAIT	NO	NO																																																														
9	GO	YES	NO																																																														
10*	WAIT	YES	NO																																																														
11	GO	YES	NO																																																														
12*	WAIT	NO	YES																																																														
13	GO	NO	YES																																																														

(See note)

(*) +16 with automatic switch to GO if PV-SP > 0,5% f.s.
 +32 with automatic switch to GO if PV-SP > 1% f.s.
 +64 with automatic switch to GO if PV-SP > 2% f.s.
 +128 with automatic switch to GO if PV-SP > 4% f.s.

263	SPS	R/W	Softstart setpoint (hot channels preheating)	Lo.L ... Hi.L	100
264	SoP	R/W	Softstart power (hot channels preheating)	-100.0 ... 100.0%	0,0
147	SoF	R/W	Softstart time	0.0 ... 500.0 min	0,0

Status

bit. 63	- - -	R	Softstart in progress
---------	-------	---	-----------------------

1.19 Valves parameter

Settings valid only for Geflex Valves models.

191	hd.1	R/W	Enabling multiset instrument management via serial	<table border="1"> <thead> <tr> <th>hd.1</th> <th>Enabling Multiset</th> <th>Enabling instrument via serial</th> <th>If "GTS-L or R" module is present</th> <th>If "RR" module is present</th> <th>If "CC" module is present</th> <th>If "V" module is present</th> </tr> </thead> <tbody> <tr><td>0</td><td></td><td></td><td>X</td><td></td><td></td><td></td></tr> <tr><td>1</td><td>X</td><td></td><td>X</td><td></td><td></td><td></td></tr> <tr><td>2</td><td></td><td>X</td><td>X</td><td></td><td></td><td></td></tr> <tr><td>3</td><td>X</td><td>X</td><td>X</td><td></td><td></td><td></td></tr> <tr><td>4</td><td></td><td></td><td></td><td>X</td><td></td><td></td></tr> <tr><td>5</td><td>X</td><td></td><td></td><td>X</td><td></td><td></td></tr> <tr><td>6</td><td></td><td>X</td><td></td><td>X</td><td></td><td></td></tr> <tr><td>7</td><td>X</td><td>X</td><td></td><td>X</td><td></td><td></td></tr> <tr><td>8</td><td></td><td></td><td></td><td></td><td>X</td><td></td></tr> <tr><td>9</td><td>X</td><td></td><td></td><td></td><td>X</td><td></td></tr> <tr><td>10</td><td></td><td>X</td><td></td><td></td><td>X</td><td></td></tr> <tr><td>11</td><td>X</td><td>X</td><td></td><td></td><td>X</td><td></td></tr> <tr><td>16</td><td></td><td></td><td></td><td></td><td></td><td>X</td></tr> <tr><td>17</td><td>X</td><td></td><td></td><td></td><td></td><td>X</td></tr> <tr><td>18</td><td></td><td>X</td><td></td><td></td><td></td><td>X</td></tr> <tr><td>19</td><td>X</td><td>X</td><td></td><td></td><td></td><td>X</td></tr> </tbody> </table>	hd.1	Enabling Multiset	Enabling instrument via serial	If "GTS-L or R" module is present	If "RR" module is present	If "CC" module is present	If "V" module is present	0			X				1	X		X				2		X	X				3	X	X	X				4				X			5	X			X			6		X		X			7	X	X		X			8					X		9	X				X		10		X			X		11	X	X			X		16						X	17	X					X	18		X				X	19	X	X				X	0
hd.1	Enabling Multiset	Enabling instrument via serial	If "GTS-L or R" module is present	If "RR" module is present	If "CC" module is present	If "V" module is present																																																																																																																						
0			X																																																																																																																									
1	X		X																																																																																																																									
2		X	X																																																																																																																									
3	X	X	X																																																																																																																									
4				X																																																																																																																								
5	X			X																																																																																																																								
6		X		X																																																																																																																								
7	X	X		X																																																																																																																								
8					X																																																																																																																							
9	X				X																																																																																																																							
10		X			X																																																																																																																							
11	X	X			X																																																																																																																							
16						X																																																																																																																						
17	X					X																																																																																																																						
18		X				X																																																																																																																						
19	X	X				X																																																																																																																						

If module "CC" or "RR" present see rL.1 parameter for Out1 and Out7 impostation.
 If module "V" present Out1 = open, Out7 = closed.
 +32 if Out2 = "C" (continuous).
 +64 output 1 function attributed to output 7, Out1 = OFF

194	A.12	R/W	Select type of auxiliary input sensor	<table border="1"> <thead> <tr> <th>AI.2</th> <th>Signal</th> </tr> </thead> <tbody> <tr><td>0</td><td>0 ... 10V</td></tr> <tr><td>1</td><td>2 ... 10V</td></tr> <tr><td>2</td><td>0 ... 20mA</td></tr> <tr><td>3</td><td>4 ... 20mA</td></tr> <tr><td>4</td><td>Potentiometer</td></tr> </tbody> </table>	AI.2	Signal	0	0 ... 10V	1	2 ... 10V	2	0 ... 20mA	3	4 ... 20mA	4	Potentiometer
AI.2	Signal															
0	0 ... 10V															
1	2 ... 10V															
2	0 ... 20mA															
3	4 ... 20mA															
4	Potentiometer															

181	tP.2	R/W	Auxiliary analogue input function	<table border="1"> <thead> <tr> <th>tP.2</th> <th>auxiliary input function</th> <th>SETTING LIMITS LS.2</th> <th>H.tA1</th> </tr> </thead> <tbody> <tr><td>0</td><td>none</td><td>-</td><td>-</td></tr> <tr><td>1</td><td>remote setpoint</td><td>Absolute Lo.S relative -999</td><td>Absolute Hi.s relative +999</td></tr> <tr><td>2</td><td>analogue remote manual</td><td>-100.0%</td><td>+100.0%</td></tr> <tr><td>3</td><td>analogue power reset</td><td>-100.0%</td><td>+100.0%</td></tr> <tr><td>5</td><td>valve position</td><td>0.0</td><td>+100.0%</td></tr> </tbody> </table>	tP.2	auxiliary input function	SETTING LIMITS LS.2	H.tA1	0	none	-	-	1	remote setpoint	Absolute Lo.S relative -999	Absolute Hi.s relative +999	2	analogue remote manual	-100.0%	+100.0%	3	analogue power reset	-100.0%	+100.0%	5	valve position	0.0	+100.0%	0
tP.2	auxiliary input function	SETTING LIMITS LS.2	H.tA1																										
0	none	-	-																										
1	remote setpoint	Absolute Lo.S relative -999	Absolute Hi.s relative +999																										
2	analogue remote manual	-100.0%	+100.0%																										
3	analogue power reset	-100.0%	+100.0%																										
5	valve position	0.0	+100.0%																										

242	At.ty	Valves control type	<table border="1"> <tbody> <tr><td>0</td><td>disabled</td></tr> <tr><td>1</td><td>V0 Heat action</td></tr> <tr><td>2</td><td>V2 Heat action</td></tr> <tr><td>3</td><td>V3 Heat action</td></tr> </tbody> </table>	0	disabled	1	V0 Heat action	2	V2 Heat action	3	V3 Heat action	0	+4 for cooling valve, COOL +8 valve manual control with "Raise" and "Lower" keys
0	disabled												
1	V0 Heat action												
2	V2 Heat action												
3	V3 Heat action												

238	-At-	Actuator travel time (time employed by the valve to change from entirely open to entirely closed)	0 ... 2000 sec	60
-----	------	---	----------------	----

239 126	t-Lo	Impulse min. time/actuator travel time (useful to avoid excessive valve activity)	0.0 ... 25.0% -At-	2,0
------------	------	---	--------------------	-----

240	t-H.1	Impulsive intervention threshold as percentage of valve opening time	0.0 ... 100.0% -At-	0,0
-----	-------	--	---------------------	-----

243	t.on	Minimum time for valve movement or valve ON time in movement mode	0.0 ... 100.0% -At-	0,0
-----	------	---	---------------------	-----

244	t.off	Valve OFF time in movement mode. NB: 0 = exclude t.off A value set < t.on is forced to t.on	0.0 ... 100.0% -At-	0,0
-----	-------	---	---------------------	-----

241 127	-db-	Dead zone which can be set as a percentage of the bottom of scale, symmetrical with respect to the set point (if the variable is within this band the valve is immobile and the integral action is blocked). Only for control of valve type V0, V2	0.0 ... 25.0% f.s.	0,0
------------	------	--	--------------------	-----

Status

227	ItA.1	R	Ammeter input value (fase 1), auxiliary input, remote setpoint, valve position
-----	-------	---	--

1.20 Configuration of outputs if expansion RR / CC is present

Set for all Geflex Multifunction models with functional module "CC" (double analog output) or "RR" (double relay module).
If the "CC" (double analog output) or "RR" (double relay module) HW is present, you have to configure the following parameters.

191 **hd.1** R/W Enabling multiset instrument management via serial

hd.1	Enabling Multiset	Enabling instrument via serial	If "GTS-L or R" module is present	If "RR" module is present	If "CC" module is present	If "V" module is present
0			X			
1	X		X			
2		X	X			
3	X	X	X			
4				X		
5	X			X		
6		X		X		
7	X	X		X		
8					X	
9	X				X	
10		X			X	
11	X	X			X	
16						X
17						X
18						X
19						X

If module "CC" or "RR" present see rL.1 parameter for Out1 and Out7 imposition.
If module "V" present Out1 = open, Out7 = closed.
+32 if Out2 = "C" (continuous).
+64 output 1 function attributed to output 7, Out1 = OFF

0

= RR

160 **rL.1** R/W Out 1 Allocation of reference signal

Only for hd1 = 4...11, with "RR" and "CC" modules	
Val	Function
0	HEAT (control output for heating) + Output 7 OFF
1	COOL (control output for cooling) + Output 7 OFF
2	HEAT (Output 1) + COOL (Output 7)
3	COOL (Output 1) + RAP (Output 7)
4	HEAT (Output 1) + RAP (Output 7)

+32 for logic level denied in output only for hd1 = 4...7, "RR" module
+64 option 4...20mA, 2...10V for hd1 = 8...11, "CC" module
+128 to force the output to zero only for hd1 = 4...7, "RR" module

0

421 **rAP** R/W Percentage of HEAT or COOL on output 7

0.0 ... 100.0% 100,0

152 **ct.1** R/W Cycle time for Out1 (Heat)

1...200 sec. (0.1 ... 20.0 sec.) Set to 0 for GTT function 20

Set to 100msec if hd1 = 8...11, "CC" module

159 **ct.2** R/W Cycle time for Out2 (Cool)

1...200 sec. (0.1 ... 20.0 sec.) Also used for output 7 in case of +4 in hd.1 20

Set to 100msec if +32 in hd1, Out2 = "C" (continuous)

1.21 Serial

Every Geflex Master is equipped with an optically isolated RS485 serial port with Modbus protocol as standard (optional: Profibus_DP or CANopen protocol).

Attention: the mode referring to one of the following parameters interrupts communication.

To set parameters **bAu** and **PAr**, you have to run the Autobaud procedure specified in the "Operating Instructions and Warnings" manual. For Slave parameter (od you have to run the Autonode procedure. For the Master, simply turn the instrument off and back on.

Settings

45 **bAu** R/W Baudrate selection

bAud	Baudrate
0	1200
1	2400
2	4800
3	9600
4	19200

4

47 **PAr** R/W Parity selection

_PAr	Parity
0	No parity
1	Odd
2	Even

0

46 **Cod** R/W Unit identification code

0 ... 99 1

1.22 Configuration of Virtual Instrument

Management of the virtual instrument via serial is activated with the **hd.1** parameter

By setting the S.In and S.Ou parameters, you can enable writing of a few variables from the serial line to set input values and output state.

You have to enable alarm limits AL1, ..., AL4 when the write operations are continuous and you don't have to keep the last value in eeprom.

Enabling the PV input lets you exclude local acquisition of Tc or RTD, replacing it with the value written in the VALUE_F register.

Enabling digital input IN lets you set the state of this input, for example, to perform MAN/AUTO switching with writing of the appropriate bit 7 in the V_IN_OUT register.

In analog mode, you can set the ON/OFF state of outputs OUT1, ..., OUT6 by writing the bit in the V_IN_OUT register.

The following table shows the register addresses.

Parameter	bit	Resource enabled	Image register address	Format	Register name
S.In	0	Alarm limit AL1	341	word	AL1_RAM
	1	Alarm limit AL2	342	word	AL2_RAM
	2	Alarm limit AL3	343	word	AL3_RAM
	3	Alarm limit AL4	321	word	AL4_RAM
	4	PV input	347	word	VALUE_F
	5	Key board	320	word	NEW TAST
	6	-	-	-	-
S.Ou	7	Digital input IN1	344	word, bit 7	V_IN_OUT
	0	OUT 1	344	word, bit 0	V_IN_OUT
	1	OUT 2	344	word, bit 1	V_IN_OUT
	2	OUT 3	344	word, bit 2	V_IN_OUT
	3	OUT 4	344	word, bit 3	V_IN_OUT
	4	OUT 5	344	word, bit 4	V_IN_OUT
	5	OUT 6	344	word, bit 5	V_IN_OUT
	6	Led ERROR	351	word, bit 4	V_X_LEDS
7	Led STATUS	351	word, bit 5	V_X_LEDS	

Settings

191

hd.1

R/W

Enabling multiset instrument management via serial

0

hd.1	Enabling Multiset	Enabling instrument via serial	If "GTS-L or R" module is present	If "RR" module is present	If "CC" module is present	If "V" module is present
0			X			
1	X		X			
2		X	X			
3	X	X	X			
4				X		
5	X			X		
6		X		X		
7	X	X		X		
8					X	
9	X				X	
10		X			X	
11	X	X			X	
16						X
17						X
18						X
19						X

If module "CC" or "RR" present see rL.1 parameter for Out1 and Out7 impostation.
If module "V" present Out1 = open, Out7 = closed.
+32 if Out2 = "C" (continuous).
+64 output 1 function attributed to output 7, Out1 = OFF

224

S.In

R/W

Input management from serial

0 ... 255

Inputs Bit	IN 7	- 6	Kb 5	PV 4	AL4 3	AL3 2	AL2 1	AL1 0
Bit	7	6	5	4	3	2	1	0

225

S.Ou

R/W

Output management from serial

0 ... 255

Outpus Bit 7	Led Status 7	Led Err 6	OUT6 5	OUT5 4	OUT4 3	OUT3 2	OUT2 1	OUT1 0
Bit 7	7	6	5	4	3	2	1	0

Status

321

- - -

R

AL4_RAM alarm 4 from serial

1.23 Information on Instrument Function

Using the following parameters, you can identify the HW/SW on the Geflex and check its function.

Settings

197	LdSt	R/W	Function of status led	<table border="1" style="width: 100%; border-collapse: collapse;"> <tr><th>Val.</th><th>Function</th></tr> <tr><td>0</td><td>RUN</td></tr> <tr><td>1</td><td>MAN/AUTO controller</td></tr> <tr><td>2</td><td>LOC / REM</td></tr> <tr><td>3</td><td>HOLD</td></tr> <tr><td>4</td><td>Selftuning enabled</td></tr> <tr><td>5</td><td>Autotuning enabled</td></tr> <tr><td>6</td><td>IN1 repetition</td></tr> <tr><td>7</td><td>Enable serial dialogue</td></tr> <tr><td>8</td><td>Status of OUT 2 (example: 8 - "COOL" signal)</td></tr> <tr><td>9</td><td>Softstart running</td></tr> <tr><td>10</td><td>Signal SP1..SP2 (SP1 with piloting input inactive and LED off)</td></tr> </table>	Val.	Function	0	RUN	1	MAN/AUTO controller	2	LOC / REM	3	HOLD	4	Selftuning enabled	5	Autotuning enabled	6	IN1 repetition	7	Enable serial dialogue	8	Status of OUT 2 (example: 8 - "COOL" signal)	9	Softstart running	10	Signal SP1..SP2 (SP1 with piloting input inactive and LED off)	16
Val.	Function																												
0	RUN																												
1	MAN/AUTO controller																												
2	LOC / REM																												
3	HOLD																												
4	Selftuning enabled																												
5	Autotuning enabled																												
6	IN1 repetition																												
7	Enable serial dialogue																												
8	Status of OUT 2 (example: 8 - "COOL" signal)																												
9	Softstart running																												
10	Signal SP1..SP2 (SP1 with piloting input inactive and LED off)																												
				+ 16 LED flashing if active (excluding code 8)																									

305	- - -	R/W	STATUS_W	<table border="1" style="width: 100%; border-collapse: collapse;"> <tr><th>bit</th><th>Function</th></tr> <tr><td>1</td><td>SP1/SP2</td></tr> <tr><td>2</td><td>Start/stop selftuning</td></tr> <tr><td>3</td><td>ON/OFF</td></tr> <tr><td>4</td><td>AUTO/MAN</td></tr> <tr><td>5</td><td>Start/stop autotuning</td></tr> <tr><td>6</td><td>LOC/REM</td></tr> </table>	bit	Function	1	SP1/SP2	2	Start/stop selftuning	3	ON/OFF	4	AUTO/MAN	5	Start/stop autotuning	6	LOC/REM	
bit	Function																		
1	SP1/SP2																		
2	Start/stop selftuning																		
3	ON/OFF																		
4	AUTO/MAN																		
5	Start/stop autotuning																		
6	LOC/REM																		

Status

120	- - -	R	Manufact Trade Mark (Gefran)	5000
-----	-------	---	------------------------------	------

121	- - -	R	Device ID (GTR)	192
-----	-------	---	-----------------	-----

122	UPd	R	Software version
-----	-----	---	------------------

190	CHd	R	<table border="1" style="width: 100%; border-collapse: collapse;"> <tr><th>bit</th><th>Function</th></tr> <tr><td>0</td><td>= 1 current transformer on (CT fase 1)</td></tr> <tr><td>1</td><td>= 1 voltage transformer on (VT fase 1)</td></tr> <tr><td>2</td><td>= 1 master / = 0 slave</td></tr> <tr><td>3</td><td>= 0 CT at 40A / = 1 CT at 120A</td></tr> <tr><td>4</td><td>= 0 RS485 (MODBUS) interface / = 1 wire (PROFIBUS) interface</td></tr> <tr><td>5</td><td>CT on (fase 2)</td></tr> <tr><td>6</td><td>VT on (fase 2)</td></tr> <tr><td>7</td><td>1 = CT at 15A</td></tr> </table>	bit	Function	0	= 1 current transformer on (CT fase 1)	1	= 1 voltage transformer on (VT fase 1)	2	= 1 master / = 0 slave	3	= 0 CT at 40A / = 1 CT at 120A	4	= 0 RS485 (MODBUS) interface / = 1 wire (PROFIBUS) interface	5	CT on (fase 2)	6	VT on (fase 2)	7	1 = CT at 15A
bit	Function																				
0	= 1 current transformer on (CT fase 1)																				
1	= 1 voltage transformer on (VT fase 1)																				
2	= 1 master / = 0 slave																				
3	= 0 CT at 40A / = 1 CT at 120A																				
4	= 0 RS485 (MODBUS) interface / = 1 wire (PROFIBUS) interface																				
5	CT on (fase 2)																				
6	VT on (fase 2)																				
7	1 = CT at 15A																				

508	CHd1	R	<table border="1" style="width: 100%; border-collapse: collapse;"> <tr><th>bit</th><th>Function</th></tr> <tr><td>0</td><td>Presence TA phase 3</td></tr> <tr><td>1</td><td>Presence TV phase 3</td></tr> <tr><td>2</td><td>Presence linear auxiliary input</td></tr> <tr><td>3</td><td>Presence external TA auxiliary input</td></tr> <tr><td>4</td><td>Check load voltage phase 1</td></tr> <tr><td>5</td><td>Check load voltage phase 2</td></tr> <tr><td>6</td><td>Check load voltage phase 3</td></tr> </table>	bit	Function	0	Presence TA phase 3	1	Presence TV phase 3	2	Presence linear auxiliary input	3	Presence external TA auxiliary input	4	Check load voltage phase 1	5	Check load voltage phase 2	6	Check load voltage phase 3
bit	Function																		
0	Presence TA phase 3																		
1	Presence TV phase 3																		
2	Presence linear auxiliary input																		
3	Presence external TA auxiliary input																		
4	Check load voltage phase 1																		
5	Check load voltage phase 2																		
6	Check load voltage phase 3																		

693	UPdF	R	fieldbus board software version	<table border="1" style="width: 100%; border-collapse: collapse;"> <tr><th colspan="2">Profibus</th></tr> <tr><th>bAu.F</th><th>baudrate</th></tr> <tr><td>0</td><td>12.00 Mbit/s</td></tr> <tr><td>1</td><td>6.00 Mbit/s</td></tr> <tr><td>2</td><td>3.00 Mbit/s</td></tr> <tr><td>3</td><td>1.50 Mbit/s</td></tr> <tr><td>4</td><td>500.00 Kbit/s</td></tr> <tr><td>5</td><td>187.50 Kbit/s</td></tr> <tr><td>6</td><td>93.75 Kbit/s</td></tr> <tr><td>7</td><td>45.45 Kbit/s</td></tr> <tr><td>8</td><td>19.20 Kbit/s</td></tr> <tr><td>9</td><td>9.60 Kbit/s</td></tr> </table>	Profibus		bAu.F	baudrate	0	12.00 Mbit/s	1	6.00 Mbit/s	2	3.00 Mbit/s	3	1.50 Mbit/s	4	500.00 Kbit/s	5	187.50 Kbit/s	6	93.75 Kbit/s	7	45.45 Kbit/s	8	19.20 Kbit/s	9	9.60 Kbit/s	<table border="1" style="width: 100%; border-collapse: collapse;"> <tr><th colspan="2">Canopen</th></tr> <tr><th>bAu.F</th><th>baudrate</th></tr> <tr><td>0</td><td>1000 Kbit/s</td></tr> <tr><td>1</td><td>800 Kbit/s</td></tr> <tr><td>2</td><td>500 Kbit/s</td></tr> <tr><td>3</td><td>250 Kbit/s</td></tr> <tr><td>4</td><td>125 Kbit/s</td></tr> <tr><td>5</td><td>100 Kbit/s</td></tr> <tr><td>6</td><td>50 Kbit/s</td></tr> <tr><td>7</td><td>20 Kbit/s</td></tr> <tr><td>8</td><td>10 Kbit/s</td></tr> </table>	Canopen		bAu.F	baudrate	0	1000 Kbit/s	1	800 Kbit/s	2	500 Kbit/s	3	250 Kbit/s	4	125 Kbit/s	5	100 Kbit/s	6	50 Kbit/s	7	20 Kbit/s	8	10 Kbit/s	<table border="1" style="width: 100%; border-collapse: collapse;"> <tr><th colspan="2">Devicenet</th></tr> <tr><th>bAu.F</th><th>baudrate</th></tr> <tr><td>0</td><td>125 Kbit/s</td></tr> <tr><td>1</td><td>250 Kbit/s</td></tr> <tr><td>2</td><td>500 Kbit/s</td></tr> </table>	Devicenet		bAu.F	baudrate	0	125 Kbit/s	1	250 Kbit/s	2	500 Kbit/s
Profibus																																																														
bAu.F	baudrate																																																													
0	12.00 Mbit/s																																																													
1	6.00 Mbit/s																																																													
2	3.00 Mbit/s																																																													
3	1.50 Mbit/s																																																													
4	500.00 Kbit/s																																																													
5	187.50 Kbit/s																																																													
6	93.75 Kbit/s																																																													
7	45.45 Kbit/s																																																													
8	19.20 Kbit/s																																																													
9	9.60 Kbit/s																																																													
Canopen																																																														
bAu.F	baudrate																																																													
0	1000 Kbit/s																																																													
1	800 Kbit/s																																																													
2	500 Kbit/s																																																													
3	250 Kbit/s																																																													
4	125 Kbit/s																																																													
5	100 Kbit/s																																																													
6	50 Kbit/s																																																													
7	20 Kbit/s																																																													
8	10 Kbit/s																																																													
Devicenet																																																														
bAu.F	baudrate																																																													
0	125 Kbit/s																																																													
1	250 Kbit/s																																																													
2	500 Kbit/s																																																													
695	CodF	R	fieldbus board address node																																																											
696	bAuF	R	fieldbus board Baudrate																																																											
				<table border="1" style="width: 100%; border-collapse: collapse;"> <tr><th colspan="2">Ethernet</th></tr> <tr><th>bAu.F</th><th>baudrate</th></tr> <tr><td>0</td><td>100 Mbit/s</td></tr> <tr><td>1</td><td>10 Mbit/s</td></tr> </table>			Ethernet		bAu.F	baudrate	0	100 Mbit/s	1	10 Mbit/s																																																
Ethernet																																																														
bAu.F	baudrate																																																													
0	100 Mbit/s																																																													
1	10 Mbit/s																																																													

477	- - -	R	Instrument status	<table border="1" style="width: 100%; border-collapse: collapse;"> <tr><th>bit</th><th>Function</th></tr> <tr><td>0</td><td>AL1 or AL2 or AL3 or AL4 or ALHB.TA1, ALHB.TA2, ALHB.TA3</td></tr> <tr><td>1</td><td>input Lo</td></tr> <tr><td>2</td><td>input Hi</td></tr> <tr><td>3</td><td>input Err</td></tr> <tr><td>4</td><td>input Sbr</td></tr> <tr><td>5</td><td>HEAT</td></tr> <tr><td>6</td><td>COOL</td></tr> <tr><td>7</td><td>LBA</td></tr> <tr><td>8</td><td>AL1</td></tr> <tr><td>9</td><td>AL2</td></tr> <tr><td>10</td><td>AL3</td></tr> <tr><td>11</td><td>AL4</td></tr> <tr><td>12</td><td>ALHB</td></tr> <tr><td>13</td><td>ON/OFF</td></tr> <tr><td>14</td><td>AUTO/MAN</td></tr> <tr><td>15</td><td>LOC/REM</td></tr> </table>	bit	Function	0	AL1 or AL2 or AL3 or AL4 or ALHB.TA1, ALHB.TA2, ALHB.TA3	1	input Lo	2	input Hi	3	input Err	4	input Sbr	5	HEAT	6	COOL	7	LBA	8	AL1	9	AL2	10	AL3	11	AL4	12	ALHB	13	ON/OFF	14	AUTO/MAN	15	LOC/REM
bit	Function																																					
0	AL1 or AL2 or AL3 or AL4 or ALHB.TA1, ALHB.TA2, ALHB.TA3																																					
1	input Lo																																					
2	input Hi																																					
3	input Err																																					
4	input Sbr																																					
5	HEAT																																					
6	COOL																																					
7	LBA																																					
8	AL1																																					
9	AL2																																					
10	AL3																																					
11	AL4																																					
12	ALHB																																					
13	ON/OFF																																					
14	AUTO/MAN																																					
15	LOC/REM																																					

509	FUSE	R	<table border="1" style="width: 100%; border-collapse: collapse;"> <tr><th>bit</th><th>Function</th></tr> <tr><td>0</td><td>= 1 FUSE phase 1 interrupted</td></tr> <tr><td>1</td><td>= 1 FUSE phase 2 interrupted</td></tr> <tr><td>2</td><td>= 1 FUSE phase 3 interrupted</td></tr> </table>	bit	Function	0	= 1 FUSE phase 1 interrupted	1	= 1 FUSE phase 2 interrupted	2	= 1 FUSE phase 3 interrupted
bit	Function										
0	= 1 FUSE phase 1 interrupted										
1	= 1 FUSE phase 2 interrupted										
2	= 1 FUSE phase 3 interrupted										